

The Crow Canyon Archaeological Center Laboratory Manual, Version 1



By

Scott G. Ortman, Erin L. Baxter, Carole L. Graham,
G. Robin Lyle, Lew W. Matis, Jamie A. Merewether,
R. David Satterwhite, and Jonathan D. Till

May 2005

This publication was paid for in part by a State Historical Fund grant
from the Colorado Historical Society.

Contents

Chapter 1. Introduction.....	1 - 1
Chapter 2. The Flow of Artifacts Through the Laboratory.....	2 - 1
Chapter 3. Artifact Cataloging Procedures.....	3 - 1
Chapter 4. Artifact Identification Criteria.....	4 - 1
Chapter 5. Pottery Type Definitions.....	5 - 1
Chapter 6. Basic Pottery Analysis.....	6 - 1
Chapter 7. Detailed Pottery Analyses.....	7 - 1
Chapter 8. Stone Material Identification.....	8 - 1
Chapter 9. Bulk Chipped Stone Analysis.....	9 - 1
Chapter 10. Detailed Stone Artifact Analyses.....	10 - 1
Chapter 11. Flotation Sample Processing.....	11 - 1
Chapter 12. Preparation of the Collections for Curation.....	12 - 1
Chapter 13. Quality-Control Procedures.....	13 - 1
References Cited.....	14 - 1

Chapter 1

Introduction

This manual documents current practices of the research laboratory at the Crow Canyon Archaeological Center, a not-for-profit organization in Cortez, Colorado. The mission of our organization is to initiate and conduct archaeological research and public education programs in partnership with Native Americans and institutions with common interests. One way we accomplish this mission is by maintaining an active excavation program at ancestral Pueblo Indian archaeological sites in southwestern Colorado. These excavations produce a steady stream of artifacts and samples that must be organized, processed, analyzed, and documented if we are to fulfill the ethical obligations associated with archaeological fieldwork and succeed in the research and education aspects of our mission. The various chapters of this manual describe in detail the standard procedures we follow in our laboratory, from the time artifacts are brought in from the field until they are transferred to a permanent curation facility.

Three basic tenets guide us in our laboratory work. First, we are committed to accomplishing long-term research on a par with the finest archaeological research conducted anywhere in the world. Thus, in our laboratory procedures, we strive to analyze artifacts consistently and systematically, in ways that meet or exceed the standards set by our colleagues, and to ensure the quality of the resultant data. We also balance the long-term benefits of maintaining analytical consistency across projects with the need to collect data that squarely address the specific questions under investigation in our current project.

Second, we are committed to what former Crow Canyon research director Bill Lipe has called the “conservation model” of archaeological research (see Lipe 1974*1). Adherence to this model in practice requires that we excavate only small portions of sites, which in turn demands that we choose the locations of excavation units carefully. When choosing excavation units, we reason backward from our research questions to the types of evidence that we believe can address those questions; we then choose locations and contexts where such evidence is most likely to be uncovered. An inevitable outcome of such an approach is a focus on the quantitative sampling of artifact assemblages in various site contexts, and this puts a heavy burden on high-quality analysis of the recovered materials in the laboratory. In addition, our laboratory strives to curate collections in a manner that allows them to be used by other researchers, so as to reduce the need for more excavations in the future. This requires more than just labeling and organizing artifacts; it also requires thorough documentation of the collection in a user-friendly, well-maintained, and widely accessible database. Our goal is to make it easy for researchers outside our organization to query our database for specific artifact types from specific contexts at one or more sites we have excavated. Researchers should then be able to create lists of objects that can be retrieved easily from the curation facility.

Third, we are committed to conducting archaeological research in partnership with the general public. Each field season, thousands of schoolchildren and hundreds of adults participate in our campus-based, public education programs, a central component of which is direct participation in our research. Accomplishing high-quality lab work in this context is a challenge, but we believe it leads to better-organized and, with this manual, better-documented laboratory procedures.

In the remainder of this chapter, we discuss the way we conceptualize artifacts, the basic goals we strive to accomplish through our procedures, the institutional context in which we operate, the principles that structure our laboratory process, and potential uses of this manual by researchers, students, and the interested public.

How Crow Canyon Conceptualizes Artifacts

The primary way we conceptualize artifacts is as tangible traces of the behavior of individuals in the past. Behavioral information is embedded in artifacts in a number of ways. First, artifacts often preserve direct evidence of behavior in the form of manufacturing decisions, techniques, and processes. For example, ancient potters collected raw materials or obtained them from others, and they manipulated these materials in a sequence of steps that often left physical traces we can observe today, such as unobliterated clay-coil junctions, scrape marks, slip, and specific designs painted on the surface of a vessel. In the same way, flintknappers produced waste products when manufacturing stone tools, and these flakes and pieces of angular debris preserve direct evidence of the manufacturing processes used.

Second, artifacts preserve behavioral evidence through the functions implied by their forms, and also preserve behavioral evidence in their actual use-histories. Most of the tools and containers we recover from our excavations exhibit clear evidence of having been designed for use in specific activities. Through analysis of use wear, we can often confirm that the actual uses of these artifacts correspond to the uses for which they were designed. So when we find a worn-out or broken tool or utensil at an archaeological site we can infer that the activity for which that tool or utensil was designed was actually performed by a person at some point in the past somewhere in the vicinity of the site. For example, finding a broken stone axe implies tree-felling, a worn mano implies corn grinding, and a retouched projectile point implies hunting. It follows, then, that quantifying the number of discarded tool or container fragments of various functional types from specific proveniences at archaeological sites should tell us something about the relative frequency of various activities in different locations in the past.

Third, artifacts preserve behavioral evidence in the ways they are incorporated into the archaeological record. From ethnoarchaeological research, we know that the deposition of artifacts at archaeological sites is not random, but is patterned by a variety of conscious and unconscious behaviors. Of course, artifacts are often moved from their original locations by a variety of natural and cultural processes, but the original deposition of these artifacts was nevertheless the result of patterned human behavior. Thus, using the results of middle-range

research on site-formation processes, we can often make inferences about the behaviors that contributed to the spatial patterns we see in artifact distributions within and between archaeological sites. For example, the number and variety of artifacts in the postabandonment fill of a kiva can sometimes tell us whether or not occupation continued in adjacent structures after the kiva in question was abandoned. To make such inferences, however, we must first quantify the artifacts in the kiva fill in such a way that we can compare these deposits directly with deposits in other kivas we have excavated.

Because we believe identification of patterns in past behavior is the primary way archaeologists learn new things about the past, and because artifacts contain so much direct and indirect evidence of behavior, our laboratory procedures focus on collecting data that quantify these behaviors. That is, we use the numbers and kinds of artifacts recovered from various contexts, in conjunction with linking arguments that specify the behavioral correlates of physical characteristics of these artifacts, to study variation in past behavior in time and space. Our laboratory procedures therefore focus on generating quantitative summaries of the physical characteristics of common artifacts from various contexts, as opposed to compiling detailed, qualitative descriptions of rare artifacts. Our laboratory procedures are modeled more along the lines of a sociological survey than of an art historical study.

The Goals of Lab Work at Crow Canyon

Building on the philosophical principles that guide our research and the way in which we conceptualize artifacts, we have developed a number of specific goals that we try to accomplish through our laboratory procedures. These specific goals are highlighted below:

- We provide a basic **functional interpretation** for every artifact we collect in the field. To accomplish this, we have designed our artifact classification system to emphasize functional differences among artifacts.
- We maintain **provenience control** of every artifact from the time it comes into the lab until it leaves for a permanent curation facility. That is, no matter what happens to each artifact, we ensure that every item is associated with a provenience label specifying the precise location from which it was collected (see *The Crow Canyon Archaeological Center Field Manual* [Crow Canyon Archaeological Center 2001*1] for an explanation of how these artifacts are provenienced in the field).
- We ensure that our basic analytical procedures and the resultant data are **consistent with the current standard** in the profession. We continually review new archaeological reports to make sure that we collect data that are comparable to, and compatible with, those collected by archaeologists working at other institutions.
- We put less emphasis on detailed description of individual artifacts and more on **quantification** of common artifacts, with the goal of estimating population parameters for

functional categories of artifacts in various site contexts. Thus, we classify and count and/or weigh every artifact that comes into our lab.

- Our procedures focus more on producing complete and accurate **computer databases** than on producing paper archives. Databases are a priority because they are critical for our own research, and we believe they will facilitate the use of our collections by other researchers to a greater extent than will paper records. The contextual and analytical data recorded by contemporary archaeologists are far too detailed and voluminous for a paper archive to be an effective tool for organizing and retrieving artifacts and artifact data for research. We believe information must be stored in a well-designed relational database if it is to be a benefit to others.
- We ensure that all artifact data, even when collected by multiple analysts, in multiple studies, and at different times, are **relatable at the level of the individual object**. We do this for two reasons. First, we want to be able to combine observations made by various researchers for specific objects to facilitate identification of new patterns in material culture. For example, we identify paint and temper types for pottery sherds during different steps of our analysis, but want to ensure that in the end we can determine those sherds that exhibit various combinations of paint and temper. Second, we want to make it possible for other researchers to check our work by comparing each observation to the actual object of study. This could prove important in relating data collected by our staff to data collected by other researchers. To accomplish this goal, we ensure that every artifact that will be analyzed individually is first associated with a unique series of identifying numbers.
- We **bag and label artifacts as we analyze them**, so that there is a one-to-one correspondence between lines of data in our database and bags of artifacts in the collections. Again, we want to make it as easy as possible for other researchers to use our collections and check our work.
- Finally, we prepare our collections for **permanent curation** according to current federal and professional standards. We organize the collections to make individual bags of artifacts easier to find, and we use archival-quality packaging that is designed to last for generations.

The Institutional Context of Lab Work at Crow Canyon

The institutional context within which our laboratory operates is unique. Our lab is currently staffed by three full-time employees who work in the lab year-round and three full-time employees who work in the lab seasonally. Each of the year-round staff is responsible for managing one of the three primary areas of our operation: collections, analyses, and databases. Although these three individuals are called on to perform the various tasks described throughout this manual from time to time, they spend much of their time training and supervising the interns, volunteers, participants, and seasonal staff who actually accomplish most of the basic work. In their remaining time, our full-time staff work on a variety of tasks, including curation,

quality control, database design and management, special analyses, quantitative analysis of artifact data, and writing for professional publications.

The three staff members who assist in the lab seasonally are an educator who works in the lab during the program season, and two staff archaeologists, who work in the lab during the winter. The educator is responsible for designing and revising our educational curriculum, and is the primary instructor in participant programs. The staff archaeologists perform a wide variety of lab tasks, focusing especially on artifact analysis.

Our staff is augmented by research interns and local volunteers. Each year we offer four laboratory internships that are designed for advanced undergraduates and beginning graduate students. During their 11-week tenure, interns are trained in all aspects of our basic laboratory process, including collections management, cataloging and analysis, data entry, and quality control. The interns perform various tasks described in this manual every day, and accomplish a great deal of work over the course of a year. Our local volunteers are individuals who live within commuting distance of the Center, exhibit some aptitude for lab work, and can commit to working on a consistent schedule each week. These volunteers are trained and supervised by the lab staff while performing many artifact-processing tasks, including washing, cataloging, chipped-stone analysis, and pottery analysis. Although the number of volunteers who work with us varies from year to year, over the long term they have made an invaluable contribution to our research.

Finally, most of the labor in our lab is provided by participants in our public education programs. We involve participants of all ages in as many stages of our artifact-processing procedures as possible. The youngest students who perform lab work are elementary school students. Although these youngsters do not participate in fieldwork during their programs, they do wash artifacts from our current excavation site as part of a half-day introduction to lab work. Middle school students catalog artifacts in addition to washing them during their half-day laboratory class. These lessons also prepare the students for their first day of excavation by teaching them how to identify artifacts they will need to collect in the field. Individuals of high school age and older who are participating in a Crow Canyon program perform the same tasks as middle school students. Finally, high school students and adults who have prior experience in our programs participate in artifact analysis, data entry, and collections management during day-long laboratory classes.

The age structure of our participant labor force over the course of a year has the form of a pyramid (Figure 1.1), with elementary school students forming the largest age group at the base, middle school students occupying the middle tier, and high school students and adults, combined, forming the smallest age group at the top. For us to utilize such a varied labor force efficiently and effectively, we must take into account the varied cognitive abilities of learners in these different age groups. Fortunately, these varied abilities correspond quite well to the volume and type of work we need to accomplish. For example, every artifact we collect needs to be washed, and participants of all ages can do this effectively, with proper supervision. In contrast, only pottery sherds that are large enough to be captured in ½ inch mesh are analyzed, and we

save this more detailed work for participants of high school age and up, staff, interns, and volunteers.

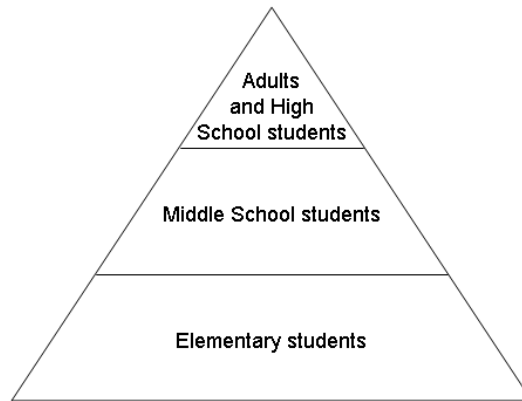

Figure 1.1. The participant pyramid at Crow Canyon.

Each year, the center offers a few week-long programs for adults that focus on laboratory analysis, but most participants contribute to our lab work as part of a broader program that includes fieldwork as well. In general, participants in these programs spend more time excavating in the field than they spend in the lab. During a week-long program, participant schedules are generally as follows: middle school students spend one day digging and a half day in the lab; adult novices, one and a half days digging and one day in the lab; high school students, two days digging and one day in the lab; and experienced adults, three and a half days digging and one and a half days in the lab. Because our participants generally spend more hours excavating than they do working in the lab, we have an incentive to make our laboratory lessons and procedures as efficient as possible. Otherwise, we run the risk of accumulating a significant backlog of unprocessed materials.

Principles that Structure Crow Canyon's Lab Procedures

To help us accomplish our goals in the institutional context described above, we have developed several general principles that structure our lab processes. These principles are embedded in all stages of our process, as the chapters of this manual attest.

- We match the expertise and cognitive abilities of various individuals to the subtlety of the observations required for a given activity. As a result, younger and/or less experienced participants are generally involved in earlier stages of processing, and older, more experienced participants assist in later stages.
- We separate the collections-management function of the lab from the research function in our procedures. Because the systems we use to organize our collections and maintain provenience control are more straightforward than are the observations we record during analysis, we load collections management tasks toward the early steps of processing that younger participants perform, and data collection tasks toward the later stages of processing that older and/or more experienced participants perform.
- We structure our procedures in ways that minimize opportunities for record-keeping errors to occur, so that fewer retroactive changes to data and labels are needed. A concrete example may help clarify this principle: Before 2001, we removed artifacts made of animal (nonhuman) bone from bags of “bulk,” unmodified, animal bone during cataloging. We assigned each bone artifact a unique Field Specimen (FS) number before sending all nonhuman bone—both modified and unmodified—to the specialist for analysis. During faunal analysis, the specialist routinely discovered additional bone artifacts that we had not previously recognized in the bags of “bulk,” unmodified animal bone. Further, the specialist commonly determined that some of the bones we had identified as artifacts during cataloging were, in fact, unmodified bones. Both situations created substantial additional work: all original records, labels and data had to be corrected. In 2001 we resolved this problem by recognizing that during faunal analysis the specialist analyzes each identifiable faunal bone individually, creates a line of data for each bone, and records modification when present. As a result, there is no reason to identify bone artifacts (an analysis task) at the cataloging stage (a collections-management task). Therefore, we changed our procedure so that we now catalog all animal bone from a provenience together and let the faunal analyst identify bone artifacts, recording them using the same system that is used for other animal bones. This has made cataloging animal bone so much simpler that we can now do it with middle school students, whereas before only staff members and interns had the expertise to do this step.
- We distinguish the series of steps involved in identifying artifacts from the criteria used to identify them. Much of the general knowledge that experts bring to bear in classifying artifacts has become second-nature through years of training and experience. We have found that this knowledge must be conveyed explicitly to participants, but that it is too extensive to be conveyed all at once. We try to alleviate this problem by formalizing the steps involved in classifying artifacts, so that we can give participants the information necessary to accomplish each step, one step at a time. For example, before one can determine that a piece of pottery should be classified as Mesa Verde Black-on-white, one first needs to recognize it as a piece of pottery, determine whether a portion of the rim of the original vessel is preserved or not, and determine the vessel form. One needs to do

this because the criteria used to assign sherds to pottery type varies, depending on the form and part of the vessel one has to work with. It is therefore critical that participants correctly identify the form and part of each decorated sherd before attempting to assign it to a pottery type. Thus, identification of form and part are distinct steps in the pottery-sorting process that each utilize specific identification criteria.

- We tailor the level of supervision to the subtlety of observation required in a given task. The ratio of staff to participants in washing artifacts can be as high as 20 to 1, because the only thing participants must do at this stage is make sure the artifacts are cleaned well and do not get mixed with those from other proveniences. The ratio of staff to participants for cataloging, however, is normally no greater than 5 to 1, and for pottery analysis, no greater than 3 to 1.
- We strive to maintain a balance between efficiency and accuracy. Many of the research questions we pursue are addressed through quantitative comparison of assemblages from various contexts. In statistical language, we use **samples** of artifacts from various contexts to estimate unknown parameters of the total artifact **population** from which the sample was drawn. Because we work with samples and not with populations, our estimates of population parameters will always be subject to some degree of error, even if every single artifact recovered in our sample is analyzed and recorded correctly. Thus, the need to quantify our artifact samples accurately must be balanced against the reality that our population parameter estimates will always be imperfect and that we have limited resources to bring to bear in processing collections. We therefore focus on procedures that lead to practical improvement in the population parameter estimates we use in our research (such as the proportions of artifacts of various types in an assemblage), as opposed to focusing on accuracy for its own sake.
- We attempt to minimize the number of recording steps that take place between sorting artifacts and entering the resultant data in our research database. As was mentioned above, two primary goals of our processing procedures are (1) to create computer databases that store accurate provenience and analysis information for each artifact and (2) to organize the collection in such a way that each computer record corresponds to the label and contents of a specific bag of artifacts. Whether the intervening paperwork corresponds to computer records and bag labels is in a sense immaterial, but when it does not match we need to determine where the inconsistency lies and make sure the labels, artifacts and data in the computer are correct and in agreement. Because errors and inconsistencies can be introduced every time information is written down, there will be fewer opportunities for us to make errors if we record this information fewer times before entering it in the computer. For example, during pottery analysis, we bag sherds in such a way that each bag has a label that describes its contents, and each bag and label correspond to a line of data in our pottery database. We enter pottery data into the database directly from the bag label, so that the person entering the data can check that the label accurately describes the sherds inside the bag. In contrast, if we were to enter pottery data from a separate recording sheet, the person entering the data would not be

able to verify the correspondence between the sherds, the analysis label, and the computer data.

- Finally, we have found that working deliberately and accurately takes less time over the long run than working quickly and fixing errors retroactively. For example, it takes more time to find a particular bag of artifacts with a recording error on its label than it does to check the label when it is first written. Similarly, solving logical inconsistencies in the data for a group of artifacts is easiest when the artifacts are in front of you, rather than filed away in curation.

Potential uses of this manual

This manual is the most systematic attempt yet made by our staff to put down on paper the full extent of our collective knowledge and experience. We believe the information contained herein will be useful to a variety of people, and for a variety of purposes. In Table 1.1, we list the chapters of this manual and indicate which might be most useful to different kinds of users.

First and foremost, we hope this manual documents our lab processes thoroughly enough that Crow Canyon staff will be able to use it to train interns, volunteers, participants, and new staff in our basic procedures for years to come. All chapters of this manual should be useful for training new staff; chapters that deal specifically with processing procedures should be helpful in training interns and volunteers.

Second, we hope this manual will be a useful tool for researchers working with artifact data generated by our lab. Crow Canyon artifact data appear in numerous works published in books, journals, and other print media as well as in a number of resources published on Crow Canyon's web site (www.crowcanyon.org). The latter include site reports and databases for individual excavation projects and a multisite research database that allows users to submit queries, generate artifact data tables, and download these data for their own purposes. This manual provides an explanation of every artifact code and category that might be encountered in the course of using these resources to conduct one's own research. The chapters that will be most useful to researchers working with our artifact data are those that present definitions of the categories we use in analyzing artifacts.

Third, we hope the information in this introduction, as well as in the chapters that focus on processing procedures and quality-control measures, will be of interest to archaeologists who are setting up research laboratories or artifact-processing systems for their own projects or institutions. Because we are continuously engaged in organizing, analyzing, and documenting collections from excavations, and because we perform these tasks in the context of an ongoing public education program, we believe we have developed some expertise in such areas as efficiency in laboratory procedures, quality control, integrating lab work with relational databases, and teaching artifact analysis to novices. We hope our collective experience,

presented in the following pages, will help other lab managers design procedures that work efficiently and produce high-quality data and well-organized collections.

Finally, we hope that participants in our programs, as well as other individuals who are interested in learning how to identify artifacts from ancestral Pueblo archaeological sites, will find this manual a useful learning aid. The Four Corners country is blessed with an abundance of ancestral Pueblo archaeological sites, many of which are accessible to the public. The chapters of this manual that focus on artifact analysis procedures should be very helpful for those who want to explore such places as Mesa Verde National Park, Canyons of the Ancients National Monument, Natural Bridges National Monument, Canyonlands National Park, and the various public lands of southwestern Colorado and southeastern Utah. We hope this manual will reinforce how much can be learned from proper study of artifacts at archaeological sites and, consequently, how important it is to leave these artifacts in place for the benefit and enjoyment of future generations.

Table 1.1. Chapters that will be of Interest to Various Users.

Chapter Number	Chapter Title	User			
		Crow Canyon interns and volunteers	Researchers	Lab Managers	General Public
2.	The Flow of Artifacts Through the Laboratory	X		X	
3.	Artifact Cataloging Procedures	X		X	X
4.	Artifact Identification Criteria		X		
5.	Pottery Type Definitions		X		
6.	Basic Pottery Analysis	X		X	X
7.	Detailed Pottery Analysis	X	X		
8.	Stone Material Identification	X	X		X
9.	Chipped-Stone Analysis	X	X	X	X
10.	Analysis of Bifaces, Points, and Drills		X		X
11.	Flotation Sample Processing	X			
12.	Preparation of Collections for Curation	X		X	
13.	Quality-Control Procedures	X		X	

Chapter 2

The Flow of Artifacts through the Laboratory

This chapter includes a flowchart (Figure 2.1) that diagrams the way we process artifacts and samples in the Crow Canyon laboratory. This chart illustrates that we follow a specific sequence in processing artifacts recovered during fieldwork. Although the chart itself is fairly simple, the task of organizing, cleaning, analyzing, managing, and interpreting artifacts is complex and time-consuming—it can easily take four to six years to completely process all the materials recovered from a single excavation project. Several hundred thousand artifacts are typically collected during a 3-4 year Crow Canyon excavation project. It is in the laboratory that we bring order to this volume of material, ensuring that all collected items are properly cared for and examined and that the relevant analytical data are collected and entered into our database.

As indicated at the top of the chart, lab work begins when bags of artifacts, accompanied by field inventory forms, are submitted by the field staff. Subsequent steps detailed in the chart illustrate how artifacts and samples are organized in the lab and how various individual artifacts, “bulk” artifacts, and samples are processed. The lower half of the chart shows that certain kinds of artifacts receive detailed analysis—that is, data for each specific item is recorded and entered into our database. After analysis and data entry are complete, the artifacts are organized and packaged for curation. The last step, indicated at the bottom of the chart, occurs when the entire collection from a field project is turned over to a permanent curation facility.

The key on the flow chart distinguishes artifact categories (white boxes) from processing activities (gray boxes) and data entry (red boxes). Staff and interns perform every processing activity and data-entry step listed on this chart. Volunteers and program participants perform only those activities marked with an asterisk (*).

Although the titles of chapters in this manual and the sequence in which the chapters are presented differ somewhat from what is shown on the flowchart, all the artifact categories, activities, and data-entry tasks represented on the flowchart are accounted for in the body of this document. The table of contents should be consulted to find out where information about specific components of our laboratory process can be found.

Readers will notice that human remains are not considered in Figure 2.1. We have left this category off the flowchart because our treatment of human remains has varied from project to project, and our current practice is to make every effort to avoid collecting human remains. Readers should consult the chapters on human remains in individual site reports for further information on how remains from specific sites have been treated. Crow Canyon has a formal policy on the treatment of human remains, which was developed in consultation with the Center’s Native American advisory group and has been endorsed by the Board of Trustees. This policy is published in Crow Canyon’s field manual (Crow Canyon Archaeological Center 2001*1).

Figure 2.1. The Flow of Artifacts Through the Laboratory

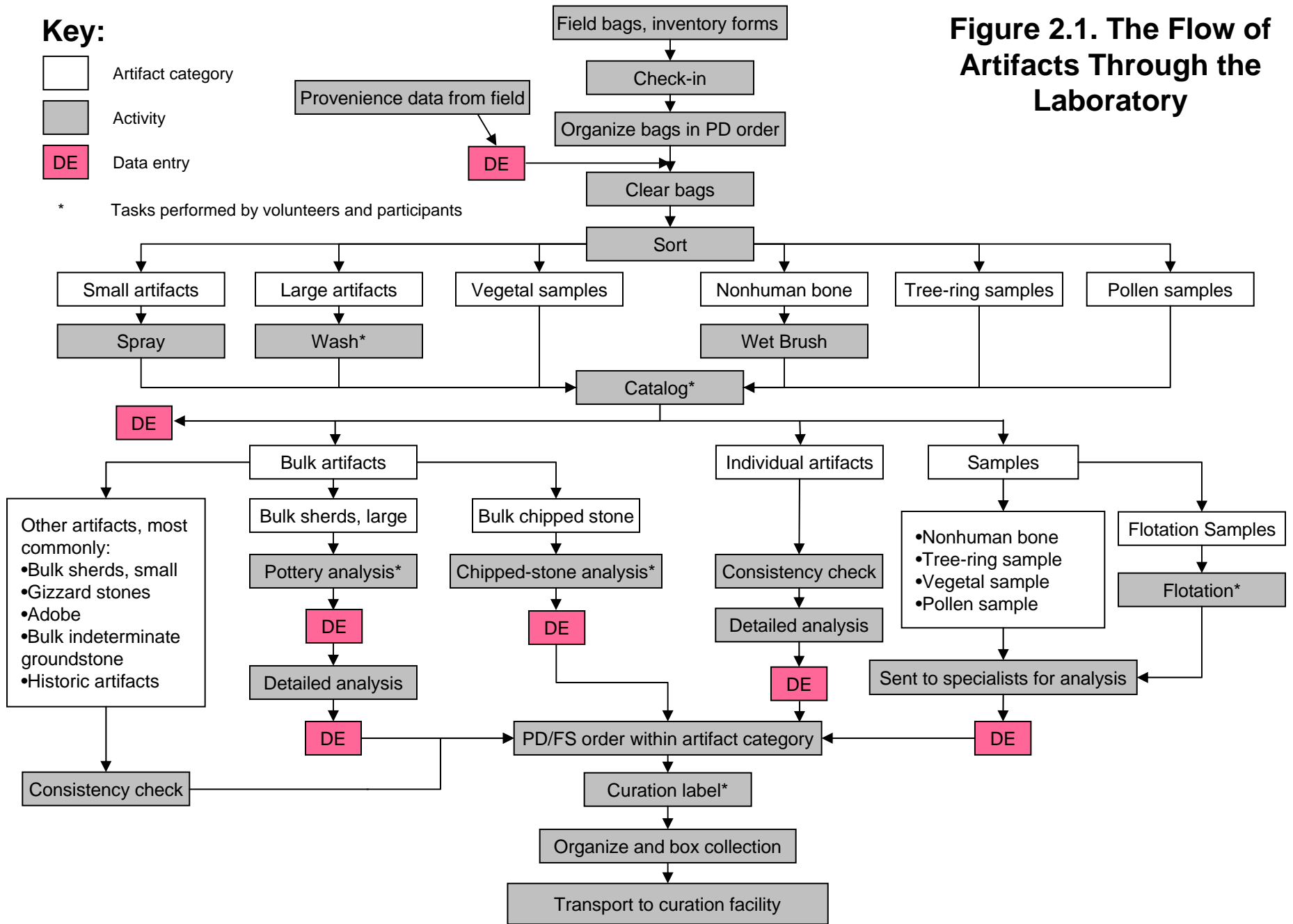

Chapter 3

Artifact Cataloging Procedures

The purpose of cataloging artifacts is threefold: to assign artifacts and samples to artifact categories, to record basic information about the artifacts, and to assign a catalog number to all materials. The catalog number at Crow Canyon is called a Field Specimen, or FS, number. An FS number is assigned to each artifact, group of like artifacts, or sample that is collected from a site. In the field, any given excavated space is assigned a provenience designation (PD) number. The provenience associated with each number is described in terms of study unit type and study unit number (for example, “Structure 1201”) and the specific horizontal and vertical location within the study unit (for example, “East Half, Stratum 2”). (See The Crow Canyon Archaeological Center Field Manual, pages 1-3, for a detailed explanation of the provenience system [Crow Canyon Archaeological Center 2001*1]). Together, these two numbers, the PD followed by the FS, provide a unique identifier for every sample, artifact, or group of like artifacts collected from a site. The two numbers are used for managing and organizing the artifact collection and, equally important, for managing artifact data in the artifact database.

Cataloging occurs after the initial sorting and cleaning of the artifacts (see Chapter 2, flowchart). At Crow Canyon, we rely on the help provided by program participants (sixth graders through adults), volunteers, interns, and staff to accomplish this task.

Cataloging is the important first step that sets the stage for the more detailed analysis of the artifacts that takes place later. As stated above, it is during cataloging that artifacts are assigned to a specific artifact category and given a unique number comprised of a PD number and an FS number. During later steps of analysis, the PD-FS number combination is entered into the computer database along with the data generated during analysis. The PD-FS numbers link multiple tables in the database and are critical for later comparative studies that form the basis of interpretation.

The PD-FS combination is also used to physically organize and manage the materials collected from a site. The numbers facilitate retrieval of specific artifacts from the collection, much the way a library catalog number for a book makes it easy to find a book on a library shelf. Organization by artifact type and PD-FS number also prepares a collection for permanent curation at the Anasazi Heritage Center.

This chapter is composed of three main elements. The first is a Cataloging Flowchart, which is a graphic outline of the multiple steps in the cataloging process. The second element is a 23-page section (Cataloging Procedures) that provides detailed instructions about the steps presented in the flow chart. The third element, called “Universal Section,” contains instructions for performing tasks that are repeated many times during the cataloging process.

Overview: Cataloging Artifacts

To catalog artifacts, you need the following items:

- A bag of artifacts that has been cleared, sorted, and washed (Page 3-3).
- The Field Specimen (FS) Form with the same PD number as the bag of artifacts (Page 3-5).
- Several Field Specimen labels (Page 3-12).
- Several archival-quality plastic bags of assorted sizes.
- A sharpened pencil.

Keep the following information in mind as you catalog artifacts:

- Three-letter codes are used in this chapter to identify artifact categories listed on the Field Specimen (FS) Coding Sheet (see page 3-28). The three-letter codes are shown in parentheses following the names of the artifacts.
- Light blue boxes, like the one below, are used throughout this chapter to highlight important instructions or information.

Please note: Record all information written on the FS Form and the FS label in pencil.

Cataloging Procedures

The following pages walk you through our cataloging procedures, step-by-step. EVERYTHING you need to know to perform these procedures is contained in these pages. In our system, the term “artifact category” refers to anything to which we assign a field specimen (FS) number. This includes artifacts, ecofacts (see page 3-25), manuports (items that must have been brought to the site by its inhabitants), and a variety of other materials and samples.

The artifact categories we work with are grouped as follows:

- **Bulk artifact categories** are used to classify and group multiple pieces of the same artifact type, such as pottery sherds or chipped-stone debris. Bulk artifacts are cataloged by lot; that is, all the items in the group are assigned a single FS number.
- **Individual artifact categories** are used to classify a variety of relatively uncommon artifacts. These items are cataloged individually; that is each piece receives its own FS number.
- **Sample categories** are used to classify materials that provide information about the past environment. Some samples may consist of multiple items (vegetal samples, nonhuman bone); these are treated similarly to bulk artifacts. In other cases (tree-ring samples), each item is given a separate FS number.

The **FS Coding Sheet**, found on pages 3-28 and 3-29, gives a complete list of all artifact categories and explains how we we group them into bulk artifacts, individual artifacts, and samples.



Using the Universal Section

Purple boxes like the one to the left appear often in the following pages. These boxes refer to procedures and information that are relevant to multiple steps. Rather than presenting this information each time it is needed, it is presented once in the universal section at the end of this chapter (pages 3-27 through 3-34). Whenever one of these boxes is shown, you should refer to the corresponding topic in the universal section. The topics, arranged alphabetically according to the letters shown in bold, are as follows:

Bagging, **C**odes, **C**ondition, **M**aterial, **F**S Form, **L**abel, and **W**eight

You should familiarize yourself with the universal section before you begin cataloging artifacts.

Why Catalog Artifacts?

Cataloging is the process of sorting, identifying, and assigning **field specimen (FS) numbers** to the artifacts collected from each provenience at a site. The combination of a site number, a PD number, and an FS number creates a unique key for each sample, artifact or group of artifacts from a specific provenience at a specific site. That is, there are no two bags of artifacts in the world that have the same set of identifying numbers. Cataloging thus serves three functions:

- It organizes the collection for tracking and management, further study, and eventual curation.
- It accomplishes the initial identification and analysis of each artifact.
- It generates basic artifact data that are entered into our database to facilitate collections management, additional study, and statistical analysis.

Step 1: Getting Started

First, get a bag of artifacts. A staff member will help with this.

- On the bag, locate the **field bag label** (Figure 3.1). This label describes the location from which the artifacts were collected. On the top line of the label, find the PD number.
- Next, locate the **Field Specimen (FS) Form** (Figure 3.2) with the same PD number on it. Field Specimen forms are filed in notebooks in the lab and are organized numerically by PD number. Information about the artifacts you catalog will be recorded on this form.
- Confirm that the information on the field bag label matches the information at the top of the FS Form.

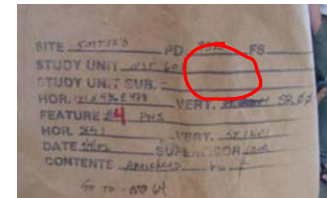

Figure 3.1. Field bag label.

Crow Canyon Archaeological Center										Site: 5MT123	
Field Specimen (FS) Form										PD: 932	
Study Unit: NST 601					SU Horizontal: 1x1 436 478					SU Vertical: SR00 1	
Feature: Feature 4 (Pit: not further specified)					Fe Horizontal: SEG 1					Fe Vertical: STLV 1-1	
FS	PL	Artifact Category	Bag Date	FS Date	Lab Sup	Cond	Mat	Count	Wght	Comments	Data Entry
											9 Initials_____
											9 Initials_____

Figure 3.2. Field Specimen (FS) Form.

Step 2: Assess the Contents of the Artifact Field Bag

You might find a number of smaller bags nested inside the large field bag (Figure 3.3). Remove these and set them aside. The description written on the contents line of these smaller bags may be any of the following:



Figure 3.3. Smaller bags you might find inside the larger field bag.



Figure 3.4. Small artifacts.



Figure 3.5. Non human bone.



Figure 3.6. Vegetal sample (charcoal).



Figure 3.7. Vegetal sample (burned corn cob).

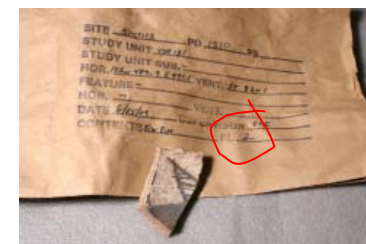

Figure 3.8. A field bag label showing PL 2, a black-on-white pottery rim.

Step 3: Check the Contents of the Small Bags

The next step is to check the contents of each small bag to make sure all items have been sorted correctly. It's often helpful to empty the contents of the bags onto a clean piece of paper to verify that the contents are all the same and that they match the "contents" line of the bag label. Once the contents have been checked, they should be put back in the bag so they don't get damaged or mixed with the contents of other bags. There are several things you should look for in the small bags:

- Any bag marked "small artifacts" should contain only small artifacts. If you see any nonhuman bone, eggshell fragments, or vegetal material these items should be removed and added to the appropriate bag(s). If no bag exists, set these items aside until you begin cataloging.
- Any bags labeled nonhuman bone should not contain vegetal material, flakes, or sherds. If you find any of these they should be removed and placed in the correct bag(s).
- Any bag marked "vegetal" or "charcoal" should contain only one kind of plant material (such as corncobs, seeds, or wood charcoal). If more than one type of material is present, they should be set aside so they can be cataloged separately. If you see any burned bone in the vegetal bag, it should be removed and added to the nonhuman bone bag.
- Each bag with a PL number should contain only one artifact, and should be identified on the contents line of the bag label. If the item in the bag doesn't match what's written on the contents line, consult a staff member.

When you're sure that everything in each small bag matches what is written on the contents line of the bag labels, set the small bags aside and move on to Step 4, (sorting the contents of the large-artifacts bag). The reason for waiting to catalog the artifacts in the small bags is that there may be items in the large-artifacts bag that also belong in one or more of your small bags.

Step 4: Sort the Contents of the Bag of Large Artifacts

Carefully empty the contents of the large-artifacts bag onto the table (Figure 3.9). Sort the artifacts into the following three categories (Figure 3.10):

- **Pottery:** If it's made of pottery, put it in a pottery pile.
- **Stone:** If it's made of stone, put it in a stone pile.
- **Other:** If it's not made of pottery or stone, put it in an "other pile."



Figure 3.9. Contents of a large-artifact bag.



Figure 3.10. Contents of a large-artifact bag sorted into pottery and stone.

Step 5: Sort the Large Pottery Sherds

Move the stone and “other” piles to the side, and focus on the pottery pile. Sort the sherds into the following three categories:



Figure 3.11. Corrugated sherds.

Corrugated pottery has a distinctive patterned texture on the exterior surface that was created when the potter pressed a finger or tool into the clay coils at regular intervals as the vessel was being formed (Figure 3.11). Occasionally, fingerprints are visible in the indentations. **Neckbanded** pottery should also be included in the corrugated pile. Neckbanded pottery has unobliterated coils on the exterior, but the coils lack the finger or tool indentations of corrugated pottery (Figure 3.12). If you see both corrugation and paint on a sherd, put it in the painted pile. In our cataloging and pottery-analysis system, paint “trumps” corrugation.



Figure 3.12. Neckbanded sherd.

Painted pottery consists of any white or gray-colored sherd with paint on it (Figure 3.13). The paint can be on the interior surface, the exterior surface and/or the rim. Most painted pottery is also slipped and polished. Examine the sherds closely because on many there is only a small painted area. If you see a red-colored sherd with or without paint on it, place it in the “other” pile.

“**Other**” pottery includes all red-colored sherds and any white or gray sherds that are neither corrugated nor painted (Figures 3.14-3.16).



Figure 3.13. Painted sherd.



Figure 3.14. Red sherd.



Figure 3.15. Gray sherd.



Figure 3.16. Unpainted white sherd.

Examples of “Other” Pottery.

For more information about pottery classification, see Chapters 5 and 6.

Step 6: Identify Modified and Shaped Sherds

After sorting the pottery into corrugated, painted and “other” categories, re-examine the sherds in each pile to determine if any have been modified in some way. If so, remove them from the “bulk” sherds and set them aside.



Figure 3.17. A modified sherd showing a ground bevel on the top edge.

Modified sherds have been ground or flaked along one edge (Figures 3.17 and 3.18). You can tell the difference between a ground edge and a finished rim edge by looking at the surface and cross section. A ground edge is a broken edge that been ground or rubbed smooth, but the cross section (showing the interior of the sherd) *is* visible. A rim edge, on the other hand, is from the original smooth lip, or rim of the vessel, and the interior cross section is *not* exposed. A modified edge may also cut across the orientation of the designs and scrape marks on a sherd. The difference between modification and use wear is that use-wear develops on the original vessel as it is used, whereas modification is created on a sherd from a broken vessel. Thus, wear on the base of a vessel or on the rim of a ladle is considered use wear, modification.



Figure 3.18. A modified sherd.



Figure 3.19. A shaped sherd, possibly a spindle whorl.

Shaped sherds have been intentionally shaped by flaking and/or grinding on all edges (Figure 3.19). They are usually round, rectangular, or triangular, and they vary in size. A shaped sherd with a small drilled hole near one corner or edge is classified as a pendant. Many small shaped sherds are probably pendants that were lost or discarded before being drilled. Large, circular sherds may have functioned as sherd containers, spindle whorls or jar lids.

Because modified sherds and shaped sherds are “individual” artifacts, they should be removed from the bulk sherds and cataloged later with other individual artifacts.

Step 7: Catalog the Bulk Sherds, Large (page 1 of 2)

1. Place each of the three pottery piles (corrugated, painted, and “other”) in a separate plastic bag.
2. Get the **Field Specimen (FS) Form**, find the first available line, and write down the next available number, which will be “1” if this is the first bag of artifacts from your PD to be cataloged.
3. On the same line, draw a dash (--) in the PL column, and write BSL (bulk sherds, large) under “Artifact Category,” as shown in Figure 3.20. Then write the bag date under “Bag Date,” today’s date under “FS Date,” and the initials of the staff person helping you under “Lab Sup” (“Lab Supervisor”).
4. Weigh all three bags of pottery together and record the weight on the FS Form.

NOTE: For bulk artifacts and samples, information is recorded in only certain columns of the FS Form. The information that should be recorded for each artifact category is highlighted in the major headings in *italic print* on the **FS Coding Sheet** (page 3-28).

W
Weight

C
Code

B
Bagging

FS numbers start with “1” and are assigned sequentially across all artifacts and artifact types within a PD.

The three-letter code (BSL) for bulk sherds, large, is written in the artifact category column.

The light blue boxes indicate what needs to be recorded for bulk sherds large.

A dash should be drawn through all columns in which nothing is recorded, as shown above. This shows us that you have not forgotten to record anything.

Figure 3.20. Field Specimen Form for bulk sherds, large.

IS	PL	Artifact Category	Bag Date	FS Date	Lab Sup	Cnd	Mat	Count	Wght	Comments	Data Entry
1	--	BSL				--	--	--			Initials
											Initials
											Initials

Step 7: Catalog the Bulk Sherds, Large (page 2 of 2)

- Fill out the **FS Label** that will go into the bag of bulk sherds. All the information you need for the FS label can be found on the field bag label or on the **Field Specimen (FS) Form**. Be careful to copy the information onto the label exactly as it is written elsewhere. Use the same FS number you recorded on the FS Form. Also, **WRITE OUT** the name of the artifact category (in this case, “bulk sherds, large”) on the contents line of the FS label, not the three-letter code you used on the FS Form. Copy the total weight from the FS Form to the appropriate line of the label.
- To secure the contents of the three bags of pottery, fold over the excess plastic; if the bags are nearly full, close them with a twist-tie instead. Then place the three bags inside a larger plastic bag, add the FS label facing out so it can be read through the bag, and close the outer bag using a twist-tie. Set this bag aside.

PLEASE: You should twist the bag tie only two half-twists. This will be sufficient for securing a bag’s contents.

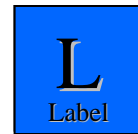

The light blue boxes indicate where information, mostly from the original artifact bag, needs to be recorded.

It is not necessary to count the sherds. Draw a horizontal line through this space.

Record the total weight of all sherds in the “weight” space.

The FS number is the same number recorded on the FS Form for this bag.

The DE (“data entry”) date, analyst, and date on the FS Label can be ignored at this time.

On the contents line write the **full name** of the artifact category as listed on the FS Coding Sheet. Do not use the three-letter code you used on the FS Form. In this cataloging step, the category name is “bulk sherds, large.”

Figure 3.21. Field specimen (FS) label for bulk sherds, large.

Step 8: Sort the Contents of the Bag of Small Artifacts



Figure 3.22. Small artifacts sorted into pottery, stone, and “other” materials.



Figure 3.23. Bulk sherds, small. Bag shown without an FS label.

Empty the paper bag labeled “Small Artifacts” onto the table and sort the artifacts into the same three groups you used with the large artifacts (Figure 3.22):

- **Pottery:** DO NOT sort the small sherds further, as you did with the large bulk sherds. The small sherds will be bagged and cataloged together in Step 9.
- **Stone:** The small stone artifacts should be added to the stone pile you created when you sorted the large artifacts. These will be sorted further in Step 10.
- **Other:** All other artifacts or materials, such as nonhuman bone, vegetal samples, shell, adobe, minerals, historic artifacts, and so on, should be added to the appropriate pile from the large-artifacts bag, if one exists, or put in their own piles for cataloging later.

Step 9: Catalog the Bulk Sherds, Small (BSS)

Assign the next available FS number on the FS Form to the bulk sherds, small (BSS). Bag the small sherds, weigh them, and record the weight on the FS Form (Figure 3.23). Next, complete an FS Label: copy the necessary provenience information and the assigned FS number; write “bulk sherds, small” on the contents line; and record the weight in the appropriate blank. Place this label inside the bag when you are done so it can be read through the plastic.

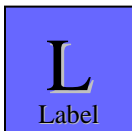
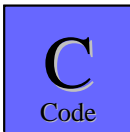

NOTE: On the FS Form, you may use “ditto” marks for information that is identical to that in the previous line (usually bag date, FS Date, and lab supervisor), and you should use dashes (—) for information that does not apply to the materials being recorded.

REMEMBER: The FS Coding Sheet specifies the information you should record on the FS Form for each artifact category.

Step 10: Sort Stone Artifacts by Modification Type (Page 1 of 2)

Sort the items in the stone pile into one of four broad modification categories – chipped stone, ground stone, battered/polished stone, and other stone. Be sure to include any stone artifacts identified during your sort of the small-artifacts (Step 8). The four categories are described below; see the FS Coding Sheet (page 3-28) for a list of the “bulk” and “individual” artifacts in each.



Figure 3.24. Chipped-stone debitage.



Figure 3.25. Projectile point, a type of chipped-stone tool.

Chipped-stone artifacts are made by chipping stone with a hammerstone or an antler flaker. Both tools and byproducts from making them are included in this category (Figures 3.24 and 3.25). Look for the following:

- Flake scars on one or more surfaces with distinct ridges between flake scars.
- Sharp edges.
- Ripples from “conchoidal fractures” (visible in the flake scars).
- A range of materials from coarse-grained silicified sandstones to non-grainy cherts, jasper, and obsidian.



Figure 3.26. This ground-stone tool exhibits shaping and dimpling.



Figure 3.27. This tool's edges exhibit shaping by flaking. The smooth surface on this stone was created by grinding.

Ground-stone artifacts may have been shaped by a variety of mechanisms, but have at least one surface that was smoothed by abrasion (Figures 3.26 and 3.27). Look for the following:

- Surfaces that are significantly smoother than the natural texture of the rock, the result of use wear.
- Evidence of shaping by flaking and pecking.
- Ground surfaces that are “dimpled,” the result of their having been pecked to facilitate grinding.
- The use of materials such as igneous rock, sandstone, and conglomerate.

Step 10: Sort Stone Artifacts by Modification Type (Page 2 of 2)



Figure 3.28. This stone shows battering damage, the result of its having been struck against other rocks.



Figure 3.29. Polished stone.



Figure 3.30. This stone has been heavily shaped and polished.



Figure 3.31. A stone like this should be placed in the “other stone” pile.

Battered/polished-stone artifacts are shaped and/or worn by battering, polishing, and/or grinding (Figures 3.28-3.30). Look for the following:

- Rough, damaged areas resulting from the repeated striking of the stone against other stones or hard materials.
- Smoothly ground surfaces, such as the polished bit of an axe.
- Highly polished areas resulting from the rubbing of the stone against softer materials.
- A variety of materials ranging from tough, grainy stone (battered stone artifacts) to fine grained material (polished stone artifacts).

Other stone artifacts are those that do not “fit” in the other three categories (Figure 3.31). Specimens in this category include unusual minerals or stones that may or may not have been modified. If you can’t decide which broad use category is most appropriate, place the artifact in the “other” pile for now.

NOTE: In our cataloging system, artifacts are classified according to their last use. Therefore, if an artifact has been modified in more than one way and you believe that the different types of modification occurred at different times, place the artifact in the category that corresponds to the **most recent** modification.

Step 11: Separate Bulk Chipped-stone from Individual Chipped-Stone Artifacts

Examine each item in the pile of chipped stone (see Step 10) and determine whether it is **bulk chipped stone** or an **individual chipped-stone artifact**.

The category “bulk chipped stone” includes debitage (unused flakes and angular debris) generated during (1) the manufacture of chipped-stone tools, (2) the deliberate modification of other kinds of stone tools, and (3) the shaping of architectural stone. It also includes two types of flake tools – modified flakes and utilized flakes – that show signs of either incidental damage through use or deliberate modification, but that still retain many of the features of the original flakes from which they were made. Figures 3.32-3.34 illustrate the attributes of flakes, flake tools, and angular debris.

Individual chipped-stone artifacts are characterized by multiple flake scars on multiples surfaces. The individual chipped-stone artifact recognized in our system are cores, modified cores, bifaces, projectile points, drills, and other chipped-stone tools. These artifact types are defined and described in Chapter 4, and photographs of examples or all but the last are provided on page 3-21.

Separate all the individual chipped-stone artifacts from the bulk chipped stone and set them aside; you will catalog them after you have finished cataloging the bulk chipped stone. Place all the pieces of bulk chipped stone in piles of 10 to facilitate counting in Step 12.

Attributes of Flakes, Modified Flakes, Utilized Flakes, and Angular Debris

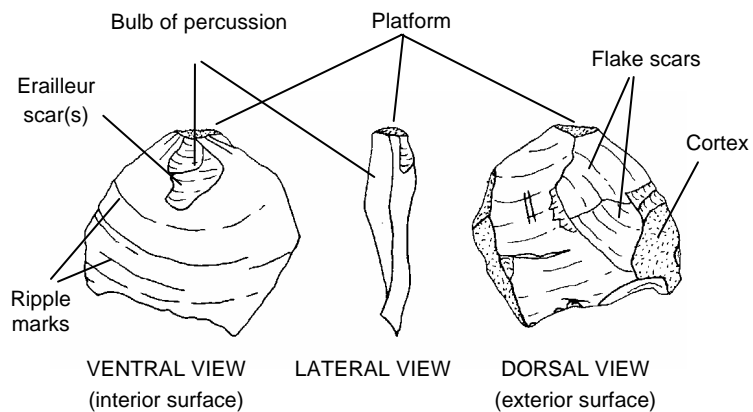

Figure 3.32. Flake attributes.

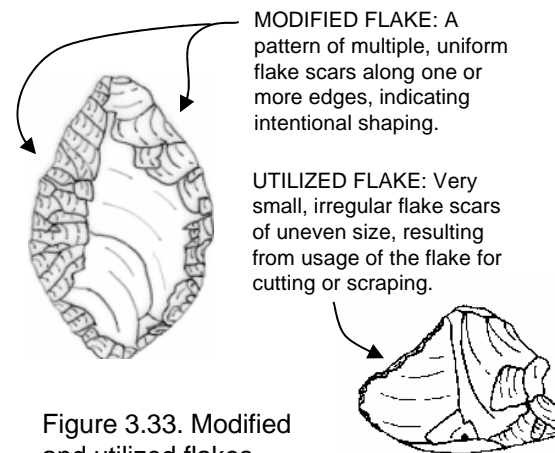

Figure 3.33. Modified and utilized flakes.

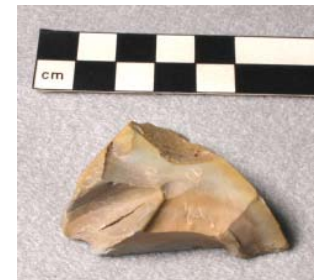

Figure 3.34. Angular debris is a by-product of chipped-stone-tool manufacture, but it lacks a bulb of percussion and is thicker than most flakes.

Once separated from the individual stone artifacts, the bulk chipped stone can be cataloged as shown on the next page.

Step 12: Catalog Bulk Chipped-stone (BCS)

Assign all the pieces of bulk chipped stone, which includes debitage and flake tools, a single FS number. Record the relevant data for the entire lot on a single line of the FS Form, fill out just one FS label, and bag all the items together in the same bag (Figure 3.35). Be sure to record lot count and weight on both the form and the label (see the FS Coding Sheet on page 3-28). Both the debitage and the flake tools (utilized and modified flakes) will receive further attention in a later stage of analysis (see Chapter 9).



Figure 3.35. Bulk chipped stone with a completed FS label. The artifacts and label are bagged together.

NOTE: Don't forget to include small flakes and pieces of angular debris identified in the small-artifacts bag in your total count and weight for bulk chipped stone!

C
Code

FS
Form

L
Label

W
Weight

Step 13: Separate the Bulk Indeterminate Ground Stone from Individual Ground Stone Artifacts

In Step 10 you identified a group of ground-stone artifacts. Now you will separate these into **bulk indeterminate ground stone** and **individual ground-stone artifacts** (**manos**, including **one-** and **two-handed manos**; **metates**, including **basin**, **trough**, and **slab metates**; **abraders**; **mortars**; and **pestles**). Read the descriptions of the various individual ground-stone artifacts on page 3-22; then carefully examine each item in the pile. If you identify any individual ground stone artifacts, set them aside for now. The remaining pieces – that is, those that are too fragmentary to be identified as one of the specific types of ground-stone tools – are “bulk indeterminate ground stone” and you will catalog them in the next step.

Step 14: Catalog the Bulk Indeterminate Ground Stone (BIG)

All pieces of bulk indeterminate ground stone that are of the same stone material type are given a single FS number, are recorded together on a single line of the FS Form, and are bagged, labeled, counted, and weighed together. As is noted on the FS Coding Sheet, bulk indeterminate ground stone is the only bulk artifact category for which material type is recorded. In most cases, the material type will be sandstone, conglomerate, or silicified sandstone. If the artifacts in your pile of bulk indeterminate ground stone are more than one material type, you will need to assign separate FS numbers.

See the universal section if you need help with recording procedures.

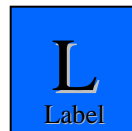

Step 15: Sort Gizzard Stones and Pebbles from the Other Stone Artifacts, and Catalog Gizzard Stones and Pebbles

Return to the Other Stone artifacts. Two kinds of small, smooth stones, which need to be distinguished, may be in this pile. These stones are **pebbles** and **gizzard stones**. Both were smoothed and polished by natural processes, but collect them from archaeological sites because of their potential cultural significance, as described below:

Gizzard stones are ecofacts that derive from turkey gizzards (Figure 3.36). Like most birds, turkeys have a small, muscular pouch at the base of the esophagus called a gizzard. Turkeys swallow small stones, which are retained in the gizzard, where they aid in digestion by grinding up food particles. Gizzard stones become highly polished through this grinding action. Because ancestral Pueblo people raised turkeys, gizzard stones are found on archaeological sites. The surfaces of gizzard stones often feel greasy to the touch. In addition to swallowing small “natural” stones, turkeys also sometimes ingested tiny flakes and even projectile points. If you can identify any gizzard stone as a “recycled” artifact, you should note this in the comments column on the FS Form.



Figure 3.36.
Gizzard stones.

Pebbles are small, smooth stones that are water worn but are not otherwise modified (Figure 3.37). The stones may be from streambeds or from conglomerate deposits. Because neither of these sources occur naturally at, or near, most sites excavated by Crow Canyon, pebbles are interpreted as manuports—objects that were carried to the site by humans. Pebbles are usually slightly rougher in appearance than gizzard stones. If the pebbles originated from conglomerate, you might see small sand grains or remnants of the matrix that originally “cemented” the conglomerate particles together.



Figure 3.37.
Pebble.

As stated on the FS Coding Sheet, gizzard stones and pebbles are counted, weighed, labeled, and recorded as a two bulk artifact groups.

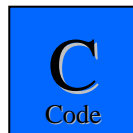

Step 16: Catalog the Individual Artifacts



Figure 3.38. Chipped-stone artifact.



Figure 3.39. Ground-stone artifact.

“Individual artifacts” fall into eight general groups: **chipped-stone artifacts** (e.g., Figure 3.38), **ground stone artifacts** (e.g., Figure 3.39) **battered/polished stone** (e.g., Figures 3.40 and 3.41), **other stone artifacts, other ceramic artifacts, ornaments, shell artifacts, and other artifacts**. If you may have identified any individual artifacts in previous steps of cataloging, it is now time to catalog them.



Figure 3.40. Battered stone artifact.

Individual artifacts are treated differently than bulk artifacts:

- Each individual artifact is given its own FS number and is recorded on a separate line on the FS Form.
- In addition to “Count” (which is always “1”) and “Weight,” “Condition” and “Material” are also recorded on the FS Form.
- Each artifact gets its own FS label and is bagged individually.

The different individual artifacts are described on pages 3-21 through 3-24; the most common artifacts are discussed first, and unusual or rare artifacts are discussed last. More-detailed descriptions of individual artifacts are provided in Chapter 4; “Artifact Identification Criteria.”



Figure 3.41. Polished stone artifact.

REMEMBER: Some individual artifacts exhibit evidence of two or more different uses. For example, a stone axe that was broken may have later been used as a core. In such cases, the artifact is classified according to its last use. It is important, however, for you to include comments regarding prior uses on the FS Form.

C
Code

Cn
Condition

FS
Form

L
Label

M
Material

W
Weight

Common Individual Chipped-Stone Artifacts



Figure 3.42. Core. Note the flake scars.



Figure 3.44. Bifaces. Note the flake scars on both the upper faces, evidence of bifacial flaking.



Figure 3.45. Small biface (left) and two small drills (center and right). Bifacial flaking is present on the biface tip while use-wear is evident on tips of the drills.

Cores are rocks from which at least one flake has been removed for purposes of supplying stone for tool manufacture (Figure 3.42). Cores are not considered tools *per se*, but they served as sources of flakes that could have been used as, or manufactured into, tools.

Modified cores are cores that were later modified, either through use or deliberate shaping, to serve some specific function (Figure 3.43). Types of modification include grinding, battering, and/or small, patterned flaking. Peckingstones are NOT classified modified cores; see the description of peckingstone under “Common Battered/Polished Tools” on page 3-23.

Bifaces are tools that were flaked on both faces but lack hafting elements -- such as notches, a stem, or fluting -- which could have been used to attach the tools to wooden shafts (Figures 3.44 and 3.45). Bifaces can be symmetrical or nonsymmetrical (see Figure 3.44, left).

Projectile points are, bifacially flaked tools that have notches, stems, flutes, or other elements that would have allowed them to be hafted to arrow or dart shafts (Figure 3.46).

Drills are tools that were used as bits for drilling holes (Figure 3.45). The tip of a drill is generally rounded and worn smooth. Drills can be formal, bifacially flaked tools with hafting elements or informal flake tools.

Other chipped-stone tools include deliberately shaped chipped-stone tools that do not fall into any of the categories listed above.



Figure 3.43. Modified core. Note the use damage on the left end and the small flake scars along the lower left edge.



Figure 3.46. Projectile points. The tools exhibit both bifacial flaking and hafting elements (notches and stem).

See Chapter 4: “Artifact Identification Criteria” if you need more-detailed information on these artifacts types.

Common Individual Ground-Stone Artifacts



Figure 3.47. One-hand and two-hand manos.

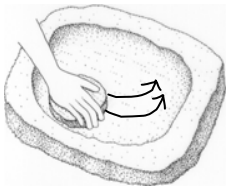

Figure 3.48. Basin metate and one-hand mano.

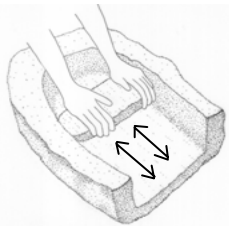

Figure 3.49. Trough metate and two-hand mano.

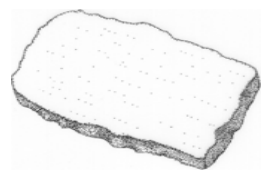

Figure 3.50. Slab metate.

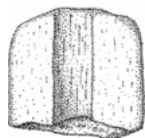

Figure 3.51. Shaft-straightener.

Manos Manos are handheld tools that were used “actively” for grinding corn on metates. Manos are usually made of sandstone. One or both surfaces of a mano will have been extensively ground, but these same surfaces will also have a characteristic “dimpling” the result of having been pecked, or “sharpened,” with another stone tool, called a peckingstone (see page 3-23). Manos are categorized by their method of use: smaller, **one-hand manos** were held in one hand and used in a circular motion (Figures 3.47 and 3.48); larger, **two-hand manos** were held in both hands and used with a back-and-forth motion (Figures 3.47 and 3.49). “**Mano**” is a generic category used for fragments that cannot be identified as either one- or two-hand manos.

Metates are the “passive” element of a grinding-tool set. Metates have one or two large, flat surfaces on which corn or other material was ground. Like the grinding surfaces of manos, those of metates are both ground and dimpled. Three metate types are distinguished in cataloging: **basin metates** (Figure 3.48), **trough metates** (Figure 3.49), and **slab metates** (Figure 3.50). Metate fragments that cannot be identified to one of these specific types are categorized simply as “metates.”

Abraders are examples of “ancient sandpaper.” These tools were used for shaping or smoothing artifacts during manufacture (Figure 3.51). Abraders are usually made of sandstone, and they could have been used actively in the hand or passively (perhaps in the lap) depending on the material that was being shaped. Stone and mineral beads and pendants, bone tools and ornaments, and wooden shafts and handles were all made using abraders. Abraders can be “expedient” tools that lack evidence of shaping prior to use, or they can be formal tools that were shaped for specific uses. The surfaces of abraders have areas that have been ground smooth, but they will lack the peckingstone dimples seen on manos and metates.

Stone Mortars are “passive” grinding stones with a round, bowl-shaped depression in which plants or minerals were pounded, ground, and/or crushed by a pestle.

Pestles are long, usually cylindrical tools that have wear on one or both ends, the result of their having been used to pound, grind and/or crush plants or minerals in a mortar.

See Chapter 4; “Artifact Identification Criteria” if you need more-detailed information on these artifacts types.

Common Battered/Polished Tools



Figure 3.52. Peckingstone. Note the flake scars and damage on the left forward ridge.



Figure 3.53. Hammerstone.



Figure 3.54. Single-bitted axe. Note the smoothly ground bit and pecked-groove hafting element.

“Battering” is the heavy damage that results when a stone tool is struck against another stone. It is usually most evident on the raised edges or ridges of a stone. “Polish” results when a stone is rubbed against a softer material, such as pottery clay or animal hide. Polish is usually confined to a specific area on a stone’s surface or edge.

Peckingstones are handheld rocks that were used to shape other stone, or to “sharpen” manos and metates by pecking out dimples which would catch and break corn kernels during grinding (Figure 3.52). Peckingstones are recognized by their multiple flake scars and distinctive pocked and battered usewear along the ridges between the scars.

Hammerstones are handheld, oval-shaped rocks used to shape chipped-stone tools (Figure 3.53). The resulting damage is usually localized on the rounded ends.

Polishing/hammerstones are pebbles or small cobbles with battering damage on rounded ends and polishing wear on one or more surfaces. These tools may have been used in leatherworking.

Axes are tools with a sharpened “bit” or cutting edge and they were used for chopping wood or removing roots and stumps from the soil (Figure 3.54). Most were initially shaped by flaking and pecking; the bit was then ground and polished to a smooth, sharp edge. Axes also have pecked grooves or notches, which allowed them to be hafted onto wooden handles. Axes can be **single-bitted** or **double-bitted**. Use the generic “axe” category only when the number of bits cannot be determined.

Mauls are relatively hefty tools with blunt ends used for breaking and shaping large pieces of stone, such as building stones (Figure 3.55). The ends are heavily battered from use. Like axes, mauls have a pecked groove or notches used to haft the tools onto wooden handles. Use **axe/maul** for fragmentary hafted tools that could have been axes or mauls.

Polishing Stones are pebbles or small cobbles that are highly polished along an edge or on one or more surfaces (Figure 3.56). Polishing stones were used extensively for polishing the surfaces of white ware pottery vessels. A small stone that is uniformly smooth on all surfaces is more likely a pebble or gizzard stone (see Step 15).

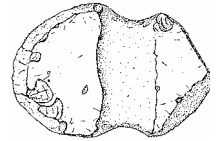

Figure 3.55. Maul. Note the battered ends and groove for handle.



Figure 3.56. Polishing stone. The high polish on the upper surface is usewear.

Uncommon Individual Artifacts

The individual artifacts listed on this page are those included on the FS Coding Sheet under the broader headings **Other Stone Artifacts**, **Other Ceramic Artifacts**, **Ornaments**, **Shell Artifacts**, and **Other**. Although the following lists include a few comments about selected artifact types, you should refer to the detailed descriptions provided in Chapter 4 for more comprehensive descriptions.

- The category “Other Stone Artifacts” includes **Modified Stone**, **Other Modified Mineral**, **Stone Disk**, and **Unmodified Stone**. Modification can include alterations such as flaking, grinding, battering, or incising.
- The category “Other Ceramic Artifacts” includes **Modified Sherd**, **Shaped Sherd**, and **Other Ceramic Artifact**. Descriptions and photographs of modified sherds and shaped sherds, see page 3-10 and Figures 3.17, 3.18, and 3.19.
- Ornaments include **Bead**, **Bracelet**, **Pendant**, **Ring**, and **Tube**. Beads, bracelets, pendants, and rings can be made of stone, pottery, shell or bone. A pendant that lacks a hole is cataloged as Other Modified Stone, but the corresponding data line should include the comment “pendant blank.” Tubes are most often made of nonhuman bone.
- The category “Shell Artifacts” is perhaps a little misleading. In this case, the category is limited to **Other Modified Shell**, which refers to a shell or shell fragment that has been modified by a human, but is not identifiable as any one of the ornament types listed above.
- The “Other” category is made up of artifacts identified as any of the following: **Basketry**, **Effigy**, **Cylinder**, **Petroglyph**, **Other Modified Vegetal**, **Textile**, **Other Modified Vegetal**, **Other**, and **Void**.

REMEMBER: All bone artifacts, including ornaments, are kept in the bulk nonhuman bone category.

Step 17: Catalog samples

Samples are primarily “ecofacts” collected for the purpose of recovering plant, animal, and mineral specimens that may be used by archaeologists to reconstruct past environments. They are also used to infer human behaviors related to the use of the environment – for example, choice of foods and construction material. The samples collected most often during Crow Canyon excavations are listed below and on the following page. For definitions and descriptions of samples collected less often, see Chapter 4. Some samples – nonhuman bone, for example – are treated like bulk artifacts; that is, all pieces of like material are cataloged together and assigned one FS number. Others, such as tree-ring samples, are treated as individual artifacts, and each individual specimen is given its own FS number. Consult the FS Coding Sheet to determine the kinds of information to record on the FS Form and FS label.



Figure 3.57. Vegetal sample (charcoal).



Figure 3.58. Vegetal sample (corncobs).

Vegetal samples consist of specimens like vegetal material (Figures 3.57 and 3.58). Thus, the charcoal and corncobs shown to the left would be assigned two separate FS numbers and would be bagged separately, even though both are vegetal samples. Use the comments column on the FS Form to identify the specific type of plant material for each sample.

Nonhuman bone consists of both modified and unmodified animal bone. With just three exceptions (discussed below), all animal bones in a given bag – even formal tools such as awls – are assigned one FS number and recorded together (Figure 3.59). The faunal analyst will later examine and catalog the modified bones both as bone specimens and as individual artifacts. The three exceptions to this rule are bone beads, pendants, and gaming pieces. Because the heavy modification of such artifacts makes it difficult for the analyst to identify the bones to species, they are treated as individual artifacts. If you identify one of these items in a bag of nonhuman bone, you should assign it its own FS number, fill out a single line on the FS Form, and label and bag it separately.

Adobe is the hardened or fired mud (jacal or daub) that was used in walls and/or roof of a structure (Figure 3.60). Only pieces of adobe that have wood or other impressions are cataloged. The other pieces can be discarded after being checked by a staff member.



Figure 3.59. Nonhuman bone.



Figure 3.60. Adobe with impressions.



Figure 3.61. Mineral (pigment).

Mineral samples are geological in origin and include materials such as hematite (a paint pigment), unfired clay, and unmodified igneous rock (Figure 3.61). The kind of material should be recorded in the material column of the FS form.

Eggshell is just that and at the sites excavated by Crow Canyon, consists of small eggshell fragments from domesticated turkeys (Figure 3.62).

Shell refers to any unmodified shell that is not an eggshell. This category includes both marine shell and terrestrial snail shell. On the FS Form, comment should be added that identifies the type of shell.



Figure 3.62. Eggshell.

Step 18: Record and Bag samples

The information recorded for samples on the FS Form and on the FS label varies by sample type, so consult the FS Coding Sheet and the pages of the universal section indicated below to determine what should be recorded.

Important: Any samples that will smudge the FS label, such as charcoal, should be double bagged, and the label should be placed between the two bags (Figure 3.63).



Figure 3.63. A vegetal sample ready for double bagging. The folded bag with charcoal will be inserted into the bag on the left and the label will be placed between the two bags.

B
Bagging

C
Code

FS
Form

L
Label

M
Material

W
Weight

Universal Section

How to Bag Artifacts

After you identify the artifact category and record all the required information on the FS Form, place the artifacts assigned a given FS number in an appropriately sized archival-quality plastic bag. Position the artifact label inside the bag so that it can be read from the outside (Figure 3.64). Before closing the bag with a twist-tie, squeeze out the excess air; then twist the tie only two half-twists. The latter is done to make it much easier to open multiple bags at a later date if the need arises.

You usually will use only one bag per FS number, but in the following instances, you will use multiple bags:

- When bagging large bulk sherds, first place the corrugated, painted, and “other” pottery in separate bags. Then place the three bags together in a larger bag along with the single FS label that you filled out for “bulk sherds, large.”
- When bagging vegetal samples and other materials that can soil or smudge the FS label, protect the label by placing the material in one bag, folding the bag over or closing it with a twist-tie, and placing it inside another bag. Then slide the FS label between the two bags so that the label can be read from the outside (Figure 3.65).

Crow Canyon uses four sizes of three-mil archival-quality polyethylene bags. The labels are printed on acid-free archival paper for long-term storage.



Figure 3.64. Bagged artifacts. Note that the label is visible and that each bag has been closed with a twist tie.



Figure 3.65. A vegetal sample ready for double bagging. The folded bag with charcoal will be inserted into the bag on the left, and the label will be placed between the two bags.



Universal Section

How to Read the FS Coding Sheet (page 1 of 2)

The FS Coding Sheet will be your main guide as you catalog artifacts. The front page of the coding sheet (shown below) is divided into three sections: Bulk Artifacts, Samples, and Individual Artifacts. As you catalog artifacts, you will record different kinds of information for artifacts in the different categories. Most artifacts are weighed, and some are counted; for others, you will need to record their condition and material. Underlined and italicized text on the FS Coding Sheet prompt you for exactly what needs to be recorded for each artifact type. The three-letter code to the right of each artifact name is what you will record in the artifact category column of the FS Form, but you should write the full name of the artifact, *not* the three-letter code, on the contents line of the FS label (see page 3-33).

CROW CANYON ARCHAEOLOGICAL CENTER FIELD SPECIMEN (FS) CODING SHEET						
BULK ARTIFACTS	SAMPLES	INDIVIDUAL ARTIFACTS				
Can have more than one item per FS number.	Can have more than one item per FS number.	Each item gets its own FS number. <i>Record condition, material, count (= 1), and weight.</i>				
<p><u>Record weight only:</u> bulk sherds, large BSL bulk sherds, small BSS adobe (impressed only) ADO</p> <p><u>Record count and weight only:</u> pebbles PEB bulk chipped stone BCS gizzard stones GIZ egg shell EGG</p> <p><u>Record material, count, and weight:</u> bulk indeterminate ground stone BIG</p> <p><u>Record count, weight, and description only:</u> unfired sherds USH HIS</p>	<p><u>Record material, count, and weight only:</u> mineral/stone sample MIN microarchaeological sample MIC</p> <p><u>Record count and weight only:</u> shell SHE microdebitage MDB microgizzard stones MGZ</p> <p><u>Record weight only:</u> nonhuman bone NHB human bone HUB human bone, not collected HNC vegetal sample VEG mortar MAR sediment SED plaster PLS human coprolite COP pack-rat midden RAT</p> <p><u>Each item below gets its own FS number; no condition material, count, or weight is required:</u> radiocarbon sample CAR tree-ring sample TRE archaeomagnetic sample ARC flotation sample FLO * fine-screen sample FIN pollen sample PLN</p> <p style="font-size: x-small;">*Record volume</p>	<p><u>Chipped Stone</u> core COR modified core MOC biface BIF projectile point POP drill DRL other chipped-stone tool CST</p> <p><u>Other Stone Artifacts</u> other modified stone/mineral OMS stone disk STD sandal last SAL</p> <p><u>Other Ceramic Artifacts</u> modified sherd MOS shaped sherd SHS other ceramic artifact OCA</p>	<p><u>Ground Stone</u> mano MAN one-hand mano OMA two-hand mano TMA metate MET basin metate BME slab metate SME trough metate TME abrader ABR stone mortar MTR pestle PES metate rest MER</p> <p><u>Ornaments</u> bead BED bracelet BRA pendant PEN ring RIN tube TUB</p> <p><u>Shell Artifacts</u> other modified shell MSH</p>	<p><u>Battered/Polished</u> peckingstone PEK hammerstone HAM polishing/hammerstone PHS axe AXE single-bitted axe SAX double-bitted axe DAX maul MAL axe/maul AXM polishing stone POS polished igneous slab PIS tchamahia TAM</p> <p><u>Other</u> basketry BAS effigy EFF cylinder CYL other OTH other modified vegetal OMV petroglyph PET textile TEX not collected NCO void VOI</p>		

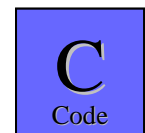

Universal Section

How to Read the Coding Sheet (Page 2 of 2)

The back page of the **FS Coding Sheet** is divided into three sections: Condition Codes, Stone Material Codes, and Other Material Codes. The condition codes allow you to record the completeness of an artifact, and the material codes record the material from which an artifact was made. These two observations are not recorded for all artifacts; the italicized and underlined instructions on the front page of the FS Coding Sheet tell you which observations to record for which artifacts. Additional information for recording condition and material is found on the following two pages.

CONDITION CODES	
complete	COM
incomplete (original size/shape <i>can</i> be estimated)	INC
fragment (original size/shape <i>cannot</i> be estimated)	FRG

STONE MATERIAL CODES						
<u>Local Stone Materials</u>			<u>Nonlocal Stone Materials</u>		<u>Other Stone Material Types</u>	
Dakota/Burro Canyon silicified sandstone	(DQT)	KDB	jet	JET	agate/chalcedony	ACH
Burro Canyon chert	(BUR)	KBC	obsidian	OBS	caliche	CAL
Morrison mudstone	(MCS)	KJM	red jasper	RJS	conglomerate	COG
Morrison chert	(MCS)	KJC	turquoise	TUR	concretion	CON
Morrison silicified sandstone	(MQT)	JMS	Washington Pass chert	WPC	gypsum/calcite/ barite	GCB
Brushy Basin chert	(BBC)	JMC	nonlocal chert/ silt stone	NCS	igneous	OIG
Sandstone		SND			petrified wood	PET
					quartz	QTZ
					slate/shale	SLS
					unknown chert/siltstone	UCS
					unknown silicified sandstone (UQT)	USS
					unknown stone	UNS
<u>Notes:</u> 1. K = cretaceous geologic period, J = Jurassic geologic period. 2. Relationships between obsolete codes and current categories are shown using parentheses and small type).						

Please note that old codes for material categories, given in parentheses and using small type, are listed in the stone material codes. These codes are no longer in use, but are reflected in our database.

OTHER MATERIAL CODES	
<u>Other Materials</u>	
clay	CLA
composite	COM
fossil	FOS
pigment	PIG
shell	SHE
unknown bone	UNB
unknown	UNK

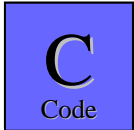

Universal Section How to Determine Condition

In the Crow Canyon system, artifact condition is recorded as: complete, incomplete, or fragment (Figures 3.66 and 3.67).

Complete (COM): The artifact's original shape and size are easily determined because no part of the artifact is missing. If an artifact is broken but all the pieces are present and can be refit to form the complete artifact, the condition should be recorded as complete, and a comment should be written on the **FS Form**.

Incomplete (INC): Enough of the artifact is present to allow you to infer its original size and shape.

Fragment (FRG): The portion of the artifact present isn't large enough or complete enough to allow you to infer the artifact's original size and shape.



Figure 3.66. From left to right, the conditions of these projectile points are recorded as complete, incomplete, and fragment.



Figure 3.67. From left to right, the conditions of these pendants are recorded as complete, incomplete, and fragment. Although the pendant in the center is smaller than the pendant on the right, enough of its original shape is present for us to infer its original size. The original length of the pendant on the right, however, cannot be determined, so it is classified as a fragment.

CONDITION CODES	
complete	COM
incomplete <small>(original size/shape can be estimated)</small>	INC
fragment <small>(original size/shape cannot be estimated)</small>	FRG

Once you have determined the artifact's condition, write the three-letter code in the "condition" column ("Cond") of the FS Form.

FS	PL	Artifact Category	Bag Date	FS Date	Lab Sup	Cond	Mat	Count	Wght	Comments	Data Entry
											9 Initials _____
											9 Initials _____



Universal Section

How to Determine Artifact Material

During cataloging, artifact material is recorded for bulk indeterminate ground stone, mineral samples, and many individual artifacts. You should familiarize yourself with the material codes on the back page of the FS Coding Sheet (shown below). Also see “Chapter 8: Stone Material Identification,” for photographs and descriptions of stone material types.

STONE MATERIAL CODES						
Local Stone Materials			Nonlocal Stone Materials		Other Stone Material Types	
Dakota/Burro Canyon silicified sandstone (DOT)	KDB		jet	JET	agate/chalcedony	ACH
Burro Canyon chert (BUR)	KBC		obsidian	OBS	caliche	CAL
Morrison mudstone (MCS)	KJM		red jasper	RJS	conglomerate	COG
Morrison chert (MCS)	KJC		turquoise	TUR	concretion	CON
Morrison silicified sandstone (MOT)	JMS		Washington Pass chert	WPC	gypsum/calcite/ barite	GCB
Brushy Basin chert (BBC)	JMC		nonlocal chert/ silt stone	NCS	igneous	OIG
Sandstone	SND				petrified wood	PET
					quartz	QTZ
					slate/shale	SLS
					unknown chert/siltstone	UCS
					unknown silicified sandstone (UQT)	USS
					unknown stone	UNS

Notes:
1. K = cretaceous geologic period, J = Jurassic geologic period.
2. Relationships between obsolete codes and current categories are shown using parentheses and small type.

OTHER MATERIAL CODES	
Other Materials	
clay	CLA
composite	COM
fossil	FOS
pigment	PIG
shell	SHE
unknown bone	UNB
unknown	UNK

FS	PL	Artifact Category	Bag Date	FS Date	Lab Sup	Cond	Mat	Count	Wght	Comments	Data Entry
											9 Initials _____
											9 Initials _____
											9 Initials _____



Universal Section

How to Fill Out the Field Specimen (FS) Form

The Field Specimen (FS) Form is used in the lab to assign and record catalog, or field specimen (FS), numbers to all artifacts and samples from an archaeological site. A separate FS Form is created for each provenience designation (PD) number. The combination of a PD number and an FS number creates a unique identifier for every sample, artifact, or group of artifacts collected from a site, and it is the means by which we track through the entire lab process. The PD number and its corresponding provenience information (the information on the field bag label) is printed at the top of the FS Form. Before you begin cataloging, verify that the information on the field bag is identical to that on the FS Form. FS numbers are assigned sequentially as information relevant to each artifact or sample is recorded.

Remember that all the forms and labels are filled out in pencil.

FS, or field specimen, numbers, are assigned sequentially as the artifacts and samples are cataloged. Each FS number is also written on its corresponding FS label (see page 3-33.)

PL, or point location, numbers identify artifacts drawn on a map made during excavation. Each artifact is put in its own field bag and the PL number is written on the field bag label. Only artifacts associated with use surfaces or ones that are unique or diagnostic are mapped. A horizontal line should be drawn in this space for artifacts that do not have a PL number.

Count is recorded for only some of the artifact categories. See the instructions on the FS Coding Sheet. For individual artifacts, the count is always "1."

Wght (weight) is recorded for most artifact types; see the FS Coding Sheet for instructions. See page 3-34 for information on weighing procedures. All weights are recorded in grams (g).

The **Comments** column is where additional information about an artifact, usually something unique or significant, is recorded.

Artifact Category refers to the three-letter code written to the right of each artifact or sample name listed on the FS Coding Sheet.

Bag Date is the date that the first materials were collected from this unit. You will find this date on the field artifact bag.

FS Date is the date the artifacts are being cataloged.

FS	PL	Artifact Category	Bag Date	FS Date	Lab Sup	Cond	Mat	Count	Wght	Comments	Data Entry
											Initials _____
											Initials _____

Lab Sup (lab supervisor) refers to the three-letter initials of the lab staff member or intern who is supervising your work.

Cond (condition) refers to the "completeness" of an artifact. An artifact can be complete, incomplete, or a fragment. Guidelines for assessing condition are provided on page 3-30.

Mat (material) is recorded for all individual artifacts and for a few bulk artifacts and samples. Refer to the material codes listed on the back of the FS Coding Sheet; also see p. 3-31. For more information on stone materials, consult Chapter 8, "Stone Material Identification."

Data Entry is filled out when the information on the FS Form is entered into the artifact database. Leave this column blank for now.



Universal Section

How to Fill Out the Field Specimen (FS) Label

A **field specimen label**, as shown below, is filled out and placed inside each archival-quality bag as materials are cataloged and assigned FS numbers. The information needed to fill out the label can be found on the original field bag label and at the top of the Field Specimen (FS) Form. This information, including any dashes, should be copied exactly onto the FS label. Dashes indicate that the information in question is not applicable; they assure us that no information was overlooked.

Remember that all forms and labels are filled out in pencil.

PD, or Provenience Designation, number is a number that identifies the horizontal and vertical location of every space that is investigated at a site. Each provenience, or space, is assigned a unique number, which is linked to information about the context in which the artifacts were found.

The **Study Unit** number identifies the specific area of investigation by study unit type, and identifies the study unit type (abbreviated STR, ARB, or NST) and number. The study unit type and number are determined by the field crew and are written on the field bag label.

The **Study Unit Horizontal** data identify a horizontal space within the study unit.

The **Feature** data identify a construction within a study unit; it is usually integrated into architecture or a surface. Examples are hearths, pits, niches, and doorways. The feature number and type are written here.

The **Feature Horizontal** data identify the horizontal location of a feature.

The **Bag Date** is the date that artifacts and samples began to be collected from this provenience. The date should be recorded as month/date/year.

The **FS**, or Field Specimen, number is the number assigned in the lab during cataloging. Each category of artifact or sample collected from a given provenience is assigned its own FS number as the FS Form is filled out. The FS number on both the FS label and the FS Form must be the same and must refer to the same artifact or sample.

The **DE Date**, or data-entry date, is the date that the analysis results for certain artifact categories are entered into Crow Canyon's database. This is left blank during cataloging.

The **PL**, or **point-location**, number identifies an artifact located on a field map drawn during excavation. A "point-located" artifact will be in its own field bag, and the PL number will be written on the field bag label. A horizontal line should be drawn in this space for artifacts not assigned a PL number. PL numbers *must* be recorded on the FS Label and the FS Form.

The **Study Unit Vertical** data identify a vertical space within the study unit.

The **Feature Vertical** data identify the vertical location of a feature.

Field Supervisor refers to the initials of the field staff or field intern supervising the excavation.

Analyst and **Date** are not filled out during cataloging. They are filled out later when the artifacts are analyzed.

Count and **Weight**, when required, are recorded here. Weight is recorded in grams. See page 3-34 for instructions on operating the scales.

The diagram shows a rectangular form with the following fields and labels:

- SITE:** 5MT123
- DE date:** _____
- PD:** _____ **FS:** _____ **PL:** _____
- STUDY UNIT:** _____
- HOR.:** _____ **VERT.:** _____
- FEATURE:** _____
- HOR.:** _____ **VERT.:** _____
- BAG DATE:** _____ **FIELD SUP:** _____
- CONTENTS:** _____
- Count:** _____ **Weight:** _____
- Date:** (written vertically on the right side)
- Analyst:** (written vertically on the right side)

Contents identifies the artifact category or sample being cataloged. The artifact category and FS number written on this label must be the same as those on the FS Form. Be sure to write the full name of the artifact category or sample (as listed on the FS Coding Sheet); do *not* use the three-letter code that you wrote on the FS Form.

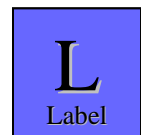

Universal Section

How to Weigh Artifacts

The lab uses digital scales to record weights to the nearest tenth of gram. The scales must be level to be accurate. This is done by turning two adjustable feet under the front of the scale clockwise or counter-clockwise until the bubble at the back of the scale is centered. Ask a staff person for assistance if needed.



Figure 3.68. View shows the Menu bar and the scale reset to read 0.0 g.

Turn on the scale by lifting up on the menu bar at the front of the scale.

Reset the scale to 0.0 grams by pressing down on the menu bar. You should reset the scale both before and after you weigh an artifact. See Figure 3.68.

When weighing a single object, such as an individual artifact or a sample that is treated individually, it is easiest to weigh the object before putting it in a curation bag. Be sure the scale is reset before placing the artifact on the scale.

When weighing multiple objects, such as bulk artifacts or samples that consist of more than one item, you can tare the scale as described below and shown in Figure 3.69.

- Place the artifacts in a curation bag without the FS label.
- Get a curation bag of the same size as the one holding the artifacts.
- Reset the scale to 0.0 by pressing down on the menu bar.
- Place the empty bag on the scale and wait until its weight is shown.
- Reset the scale to 0.0 again. Make sure that the bag stays in place until the scale display registers 0.0.
- Now remove the bag, and the scale should register the bag's weight as a negative value.
- Place the bag of artifacts on the scale. The weight shown will be the weight of the artifacts because the weight of the bag has been subtracted from the combined weight of the artifacts and the bag.



Write the weight on the FS Form and the FS label. For artifacts that weigh an even gram include a zero after the decimal point. For items that register as less than one gram, include a zero before the decimal point.

FS	PL	Artifact Category	Bag Date	FS Date	Lab Sup	Cond	Mat	Count	Wght	Comments	Data Entry
											9 Initials____
											9 Initials____



Figure 3.69. Three views showing the steps to tare the scale.

Chapter 4

Artifact Identification Criteria

In Crow Canyon's cataloging system, the term "artifact category" refers to anything to which we assign a field specimen (FS) number (see Chapter 3). This includes artifacts, ecofacts (for example, vegetal samples, faunal remains), manuports, and a variety of other materials and samples. In our system, artifacts are classified according to their last use. So, for example, a single-bitted axe that was broken and subsequently used as a core would be classified as a core and not as a single-bitted axe.

The following lists include all artifact categories currently in use, as well as a number that are not, that have been used in the past and therefore appear in our research database. The latter are distinguished below through the use of smaller typeface.

Bulk Artifacts

Artifacts that are recorded as a group and assigned a single field specimen (FS) number during cataloging are called "bulk artifacts." Many of these artifacts are analyzed further in subsequent steps in our laboratory process (see Chapter 5 and Chapter 9).

Bulk Chipped Stone (BCS). This category includes: 1) debitage, which consists of flakes and angular debris created during the manufacture of chipped-stone tools, the intentional modification of other stone tools, or the shaping of architectural stone; and 2) expedient flake tools, including utilized flakes and modified flakes. Before 2001, modified flakes (MOF) were distinguished during cataloging and assigned their own artifact category and FS number (Figure 4.1).

Bulk Indeterminate Ground Stone (BIG). Fragments of ground-stone artifacts that cannot be assigned to a more specific ground-stone category. If more than one ground surface is present on an individual fragment, this should be noted in comments. Fragments of bulk indeterminate ground stone are grouped by stone material, and each group of artifacts of a given stone material receives its own FS number. Before 2001, each piece of indeterminate ground stone (IGS) was treated as an individual artifact and assigned a separate FS number (Figure 4.2).

Bulk Sherds, Large (BSL). Unmodified pottery sherds that are captured in a screen with ½-inch mesh. All such sherds in a given bag of artifacts are grouped together and assigned a single FS number. Before the 1998 field season, all unmodified pottery sherds were classified as bulk sherds (BSH), regardless of size (Figure 4.3).

Bulk Sherds (BSH). This category was discontinued in 2000. From 1998 through most of 2000, three bulk sherd codes [BSH], [BSL], [BSS], were used. We stopped using the BSH code in late 2000, when we began to screen artifacts through ½ inch mesh to separate the larger sherds (greater than ½"), BSL, from the smaller sherds (smaller than ½"), BSS.

Bulk Sherds, Small (BSS). Unmodified pottery sherds that fall through a screen with ½-inch mesh but are captured in a screen with ¼ -inch mesh. All such sherds in a given bag of artifacts are grouped together and assigned a single FS number. Before the 1998 field season, all unmodified pottery sherds were classified as bulk sherds (BSH), regardless of size (Figure 4.4).

Gizzard Stones (GIZ). Small stones or flakes that are highly polished on their surfaces and inside all cracks and crevices. Such stones are believed to be from the gizzards of turkeys that were kept during the occupation of a site. All gizzard stones in a given bag of artifacts are grouped together and assigned a single FS number (Figure 4.5).

Historic Artifacts (HIS). Any artifacts of modern origin. They are of interest to Crow Canyon archaeologists primarily because they can tell us something about the recent use and disturbance of prehistoric sites. All historic artifacts in a given bag of artifacts are grouped together and assigned a single FS number. Specific information on the kind or kinds of historic artifacts should be noted in the comments.

Microdebitage (MDB). Chipped stone debris, identified in the heavy fraction of flotation samples, that also falls through a screen with ¼ inch mesh. All such pieces are grouped together and given a single FS number.

Pebbles (PEB). Small stones that are naturally rounded but not culturally modified. Such stones may be from streambeds or from conglomerate sandstones. In either case, they are interpreted as manuports—that is, as objects brought to a site by humans. Pebbles are usually slightly rougher in appearance than gizzard stones, and do not have the use wear characteristic of polishing stones. All pebbles are grouped together and given a single FS number.

Unfired Sherds (USH). Sherds from unfired pottery vessels. All unfired sherds are grouped together and given a single FS number.



Figure 4.1. Bulk chipped stone.



Figure 4.3. Bulk sherds, large sorted, into painted, other, and corrugated.



Figure 4.4. Bulk sherds, small.



Figure 4.2. Bulk indeterminate groundstone.



Figure 4.5. Gizzard stones.

Samples

Samples include a variety of artifacts and ecofacts that may be used to reconstruct paleo-environments and to infer resource use. Some types of samples are cataloged in “lots” and assigned a single field (FS) specimen number; others, such as the various dating samples, are treated as individual artifacts, with each assigned its own FS number.

Adobe (ADO). Before 1998, this category referred to any fragment of adobe, jacal, or daub collected in the field and brought into the lab. Since 1998, this category has referred only to adobe, jacal, or daub with wood or finger impressions. All such fragments in a given artifact bag are grouped together and assigned a single FS number (Figure 4.6).

Archaeomagnetic Sample (ARC). Archaeomagnetic samples are collected from the clay of well-fired and well-preserved hearths or other burned features. These samples may be sent to an archaeomagnetic laboratory for dating. Each archaeomagnetic sample is assigned its own FS number.

Eggshell (EGG). Eggshell fragments, most of which were probably from turkey eggs (Figure 4.7).

Fine-Screen Sample (FIN). Fine-screen samples consist of 500 ml of sediment collected for the purpose of finding small artifacts that would not be found during standard screening through 1/4-inch mesh. These samples are screen through 1/16-inch mesh, and the captured artifacts are assigned a single FS number, regardless of type.

Flotation Sample (FLO). Sediment collected from an individual stratigraphic layer or the fill of a feature for the purpose of recovering small plant remains. The vegetal remains from flotation samples are used to infer the use of plants for food, fuel and construction. When possible, flotation samples are subdivided into 1 liter samples when they are cataloged in the lab, and each liter is given its own FS number to facilitate flotation processing.

Human Bone (HUB). Crow Canyon stopped the intentional collection of human remains after the 2000 field season. However, fragmentary human remains are occasionally collected inadvertently with nonhuman bone samples, and when this occurs we use this category to catalog these remains. See page 2-1 for more information on the treatment of human remains.

Human Bone, Not Collected (HNC). Human bones that are identified by a physical anthropologist in the field. Such remains are not collected and are reburied in situ. For more information, the reader is referred to page 2-1.

Human Coprolite (COP). Human feces. Such samples can be examined by a specialist to gain information about the diet and health of a person in the past.

Microarchaeological Sample (MIC). Sediment collected for the purpose of recovering microdebitage or other small artifacts that would not be captured during standard screening through a 1/4-in mesh. These samples are may be processed using nested geological screens.

Microgizzard stones (MGZ). Gizzard stones recovered from sediment that has been screened through a mesh finer than the standard 1/4-inch mesh used for routine screening. Microgizzard stones are cataloged together and given a single FS number.

Mineral Sample (MIN). Unmodified objects of a variety of materials, including softer minerals (for example, caliche, hematite, calcite, and gypsum) and harder minerals (for example, conglomerate sandstone, igneous, quartz, turquoise, jet). It is assumed that such materials were carried to the site by humans because they do not occur widely in the local surface geology and it is known that such materials were commonly used by the ancestral Pueblo people. All specimens of a given material type are grouped together and assigned a single FS number.

Mortar Sample (MAR). Samples of mortar used in masonry wall construction.

Nonhuman Bone (NHB). Before 2001, only unmodified animal bones were cataloged as nonhuman bone, and each bone tool was cataloged separately and given an individual FS number (see the artifact categories under Bone Artifacts, below). As of 2001, this category is used to catalog *all* animal bone (*except* those objects classified as ornaments) both modified and unmodified. Modified animal bones are identified, classified, and recorded during faunal analysis (Figure 4.8).

Pack-Rat Midden Collection (RAT). These are samples of a pack-rat midden collected for the purpose of obtaining vegetal remains that can be used in paleoenvironmental reconstructions.

Plaster Sample (PLS). Samples of plaster collected from structure walls.

Pollen Sample (PLN). A sample of sediment, usually about 120 ml, that is collected from a sealed context for the purpose of recovering pollen for paleoenvironmental reconstruction. Such samples can be sent to a palynology lab for processing and analysis.

Radiocarbon Sample (CAR). Carbon 14, Radiocarbon, or C¹⁴, samples consist of charred organic material, collected from undisturbed contexts. Such samples may be sent to a radiocarbon laboratory for dating. Each radiocarbon sample is assigned its own FS number.

Sediment Sample (SED). Samples of sediment that can be used for a variety of analyses (e.g., mineralogical analysis, or in anticipation of pollen, flotation, or microarchaeological sampling).

Shell (SHE). Unmodified marine shell and local, terrestrial snail shell. If the item is a terrestrial shell, a comment should be added that identifies it as such (Figure 4.9).

Tree-Ring Sample (TRE). Pieces of burned and unburned wood that are point-located (plotted on a map) and collected for dendro-chronological analysis. Multiple pieces from the same timber are collected as a single sample and are assigned one FS number, regardless of the number of fragments contained in the field bag. These samples are sent to the Laboratory of Tree-ring Research, University of Arizona, for cross dating and species identification.

Vegetal Sample (VEG). All unworked vegetal materials that are not suitable for tree-ring analysis are cataloged as vegetal samples. In most cases, vegetal material is sorted by “material type” (charcoal, unburned wood, corn, seeds, and other vegetal) during cataloging, and the fragments of each material are cataloged separately. Modified vegetal objects are cataloged as individual artifacts when they can be identified in the field or lab (Figure 4.10).



Figure 4.6. Wood-impressed adobe.



Figure 4.7. Eggshell (turkey).



Figure 4.8. Nonhuman bone.



Figure 4.9. Shell (unmodified). *Left*, terrestrial shell; *right*, marine shell. (right).



Figure 4.10. Vegetal sample corncobs.

Individual Artifacts

A variety of easily identified tools are cataloged as individual artifacts. During cataloging, each individual artifact is assigned its own FS number and the material, condition, and weight of each artifact are recorded. Certain types of individual artifacts are subsequently subjected to additional analyses by specialists. To aid in identification, individual artifact categories are grouped into several general categories: battered and polished stone, chipped-stone, ground stone, other stone artifacts, other ceramic artifacts, ornaments, shell artifacts, bone artifacts, , and other artifacts. Individual artifact categories are listed below in alphabetical order within each general group.

Battered- and Polished-Stone Artifacts

Artifacts in this group show evidence of having been battered through used and/or polished through use and during their manufacture. A stone that has been used to break or shape another stone will have battering damage. A stone that has been used for polishing or has itself been polished will have areas that are very smooth and shiny; in some cases, parallel striations that indicate the direction of the polish will be visible. The polishing usually extends across any flake scars that may have been created when the tool was shaped during manufacture. A tool may have been both battered and polished, but usually one type of wear predominates.

Axe (AXE). A tool that can be used to fell trees, to shape wood, or as a weapon. Axes were made in a variety of ways. Most often, a piece of igneous rock or silicified sandstone was first shaped by flaking or pecking, and then hafting elements, in the form of a groove or opposed notches, were pecked into the midsection of the blank. Finally, the bit was sharpened by grinding. An axe is thickest near the groove and then tapers to a wide, but smooth and sharpened, bit. On a **single-bitted axe** (Figures 4.11 and 4.12), the cutting edge is called the “bit” and the opposite end is called the “poll.” The poll end is blunt and serves as a counterweight; it also could have been used as a maul. A **double-bitted axe** has a bit on both ends of the tool. The generic “**axe**” category is used only for polished axe fragments on which it is impossible to determine whether the original tool had a second bit or a poll opposite the identifiable bit end. Flakes from axes or ground-stone tools should be classified as bulk chipped stone. If it is clear that certain of these flakes resulted from the use of an axe, this should be recorded in the comments.

Axe/maul (AXM). A polished and battered tool fragment that is from either an axe or a maul, where the elements that would allow us to distinguish between the two are absent. For example, a fragment on which a hafting element and a poll, but not a polished bit, are preserved would be classified as an axe/maul.

Double-Bitted Axe (DAX). An axe with a sharp bit on both ends and a pecked groove or notch for attaching a wooden handle at its midsection. Double-bitted axes are usually made of igneous rock or silicified sandstone that has been modified through a combination of flaking, pecking, and polishing. The bits are usually highly polished and often exhibit

evidence of battering damage. Both ends of the axe must be present for you to distinguish a single- or double-bitted axe from a generic axe.

Hammerstone (HAM). A relatively smooth stone, often a waterworn cobble, that exhibits battering damage across broad areas on the rounded ends. Most often used for flintknapping, hammerstones are usually small enough to hold in one hand and are made of materials – such as igneous rock, silicified sandstone, and quartzite – that are harder and less brittle than those they were intended to flake. Batter is often the only type of modification present. In contrast, peckingstones have been both flaked and battered, and the battering damage tends to be concentrated along the narrow ridges between flake scars (Figures 4.13).

Maul (MAL). A stone tool with two blunt ends and a pecked groove or notch at its midsection. Mauls are not usually polished or ground, and they may exhibit evidence of heavy battering on one or both ends. Many axes with broken bits were subsequently used as mauls. Such artifacts should be classified as mauls and their previous use recorded in the comments (Figures 4.12. and 4.14).

Peckingstone (PEK). A rock with edges or ridges that have been battered through use; grinding is sometimes evident in small areas as well. Most peckingstones are essentially battered cores (the sharp edges and ridges produced when flakes are struck from a core are ideal for pecking other stone surfaces), but some peckingstones were made of large, sharp flakes or of unmodified stones with naturally sharp edges. Peckingstones were used to roughen or “sharpen,” mano and metate surfaces that had become too smooth through use to effectively grind corn. They may also have been used to shape building stones and other stone artifacts. Platform preparation on a core should not be confused with use-wear from pecking (Figures 4.15).

Polished Igneous Slab (PIS). A flat, igneous stone against which other objects were ground and rubbed, producing a polished surface.

Polishing/Hammerstone (PHS). A pebble or small cobble with battering damage on its rounded ends and polishing wear on one or more surfaces. The polishing often has both a very high sheen on the “high spots” and fine scratches or striations. Ethnographic evidence suggests that these tools were used to process animal hides.

Polishing Stone (POS). A pebble or small cobble that appears to have been used for polishing the surfaces of pottery vessels. The polishing often has both a very high sheen on the “high spots” and fine scratches or striations. Do not confuse a waterworn pebble or cobble that has a naturally smooth surface with one that has been worn smooth and polished through use (Figure 4.16).

Single-bitted Axe (SAX). An axe with a sharp bit on one end, a blunt counterweight, or poll, on the other end, and two pecked notches or a groove for attaching a wooden handle at its

midsection. Single-bitted axes are usually made of igneous rock or silicified sandstone that has been modified through a combination of flaking, pecking, and polishing. The bit is usually highly polished and often exhibits evidence of battering damage. The poll end, too, may exhibit battering damage. Both ends of the axe must be present for you to distinguish a single- or double-bitted axe from a generic axe (Figures 4.11 and 4.12).

Tchamahia (TAM). A thin, flat stone shaped like a narrow paddle, and having a sharp bit on one end. Tchamahias are initially shaped by flaking and then are ground to a fine, smooth finish; often the flake scars are totally obliterated by the grinding. Tchamahias resemble stone hoes or celts that could have been used in farming, but in ethnographic literature tchamahias are documented as having ceremonial or ritual significance (Parsons 1939:194). Examples from archaeological contexts may have been ceremonial objects as well, because they are often made of beautiful, fine-grained siltstone, and the workmanship is often very fine (Figure 4.17).

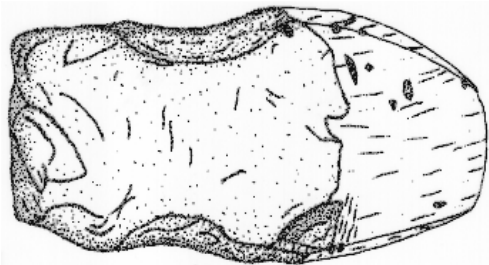

Figure 4.11. Single-bitted axe.

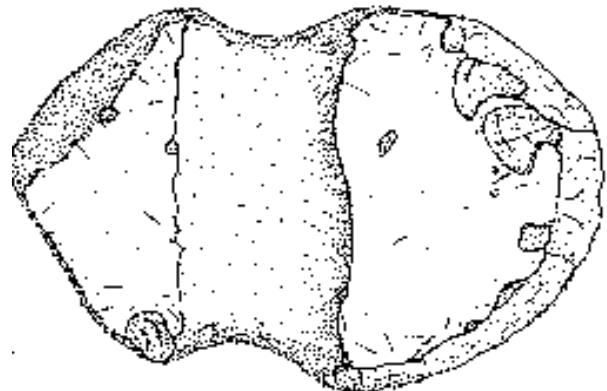

Figure 4.14. Maul.



Figure 4.12. *Top row, single-bitted axes; bottom row, mauls.*



Figure 4.15. Peckingstone.



Figure 4.13. Hammerstones.



Figure 4.16. Polishing stones.



Figure 4.17. Tchamahia.

Chipped-Stone Artifacts

Artifacts in this group are usually made of siliceous materials (for example, chert, siltstone, silicified sandstone, mudstone, and chalcedony) that tend to fracture conchoidally when struck. The tools in this group were manufactured primarily by flaking, and they lack evidence of pecking, polishing, and battering damage.

Biface (BIF). A chipped-stone tool that has been bifacially thinned but cannot be classified as a projectile point or drill. The flake scars on bifaces usually span both faces of the tool, rather than being confined to the edges only. This category can include knives, formal and informal preforms, and unclassifiable tip and midsection fragments (Figures 4.18 and 4.19).

Core (COR). Cores are not necessarily tools per se, but may they have provided flakes for subsequent tool manufacture. Cores were not usually made from flakes, although very large flakes sometimes served as cores. All cores are recognized by the presence of flake scars, curved indentations that indicate where flakes were removed. If battering is also present along the ridges between the flake scars, the core should be classified as a peckingstone. If the artifact is ground and/or polished, or if it is flaked in such a way to suggest its use as a tool, the artifact should be classified as a modified core. Platform preparation does not constitute modification. The condition of a core should be recorded as complete unless there is clear evidence of fragmentation unrelated to flaking (Figures 4.20 and 4.21).

Drill (DRL). A chipped-stone tool with a projection that was used as a bit for drilling holes. The characteristic common to all drills is a worn and polished bit. Use wear on drill bits typically consists of tiny striations oriented perpendicular to the long axis of the tool, indicating rotary motion. Drills can take a variety of forms. Some are formal, bifacially flaked tools with hafting elements – these include tools that were manufactured specifically for drilling, as well as recycled projectile points on which the tip was “retouched” to create a narrow drill bit. The bits of these formal drills are often beveled in opposite directions. Drills may also be informal, expediently manufactured tools that were held in the hand and that retain most of the characteristics of the original flakes from which they were made (Figures 4.22 and 4.23).

Modified Core (MOC). A core that was subjected to additional modification, either deliberately through flaking (“retouch”) or incidentally through use (for example, scraping)/ Use wear can consist of flaking, grinding, and/or polishing along one or more edges or ridges; a core that has been battered, however, should be classified as a peckingstone, not as a modified core. The flake scars along a modified edge should be small and regular enough to suggest use or deliberate shaping, rather than the removal of flakes for stone tool manufacture. Platform preparation does not constitute modification (Figures 4.24 and 4.25).

Modified Flake (MOF). As of 2001, we include modified flakes in the bulk chipped stone category during cataloging; they are identified and analyzed specifically during bulk chipped-stone analysis (see Chapter 10). Before 2001, however, modified flakes were distinguished as individual artifacts during cataloging and were recorded in our research database as such. A modified flake is a flake with one or more edges that were deliberately modified through unifacial flaking. Use-wear by itself does not constitute modification. The flake scars along a modified edge (1) usually are oriented perpendicular to the edge, (2) are regular enough to suggest deliberate modification of the edge rather than incidental damage or wear through use, and (3) must clearly represent flakes that were removed after the original flake was detached from the core. A modified flake still shows at least some of the characteristic features of the flake from which it was made (platform, bulb, ripples on the ventral face, etc.). A chipped-stone tool not made from a flake, or one made from a flake on which most of the original flake features have been obliterated by subsequent modification, should be classified as one of the other chipped-stone tool types. Modified flakes may or may not exhibit evidence of use, but when such evidence was visible, a note was made in the comments.

Other Chipped-Stone Tool (CST). A stone tool, deliberately shaped by flaking, that does not fall into any other category of chipped-stone tool. Examples include (1) "chunks" or pieces of rock that are not flakes or cores, but that have at least one edge that was modified by flaking, and (2) heavily modified flakes with unusual forms. A comment should be added to the FS form that describes the tool.

Projectile Point (POP). A formal chipped-stone tool that appears to have functioned as an arrow point, spear point, or dart point. Projectile points were deliberately shaped by bifacial flaking, and they possess a hafting element. Before 1994, all bifacially flaked tool fragments on which hafting elements were absent were classified as bifaces. Since that time, we have taken size into account, and bifacially flaked tips of appropriate size are now classified as projectile points even if the hafting elements are missing (Figures 4.26 and 4.27).



Figure 4.18. Bifaces.



Figure 4.19. Close-up of biface shown in Figure 4.18.



Figure 4.20. Cores.



Figure 4.21. Core.



Figure 4.22. Drills.

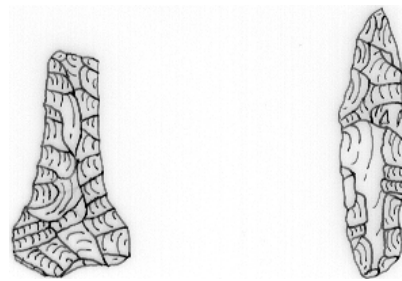

Figure 4.23. Drills.



Figure 4.24. Modified core.



Figure 4.25. Modified core.

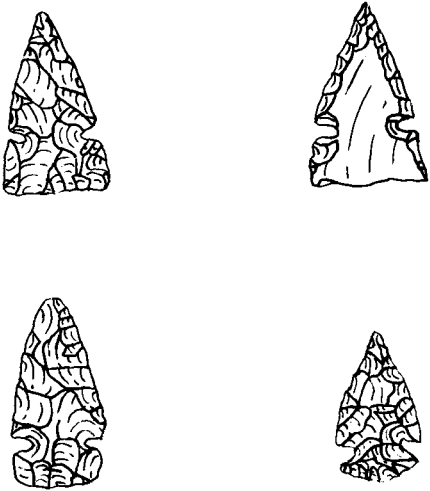

Figure 4.26. Projectile points (actual size).

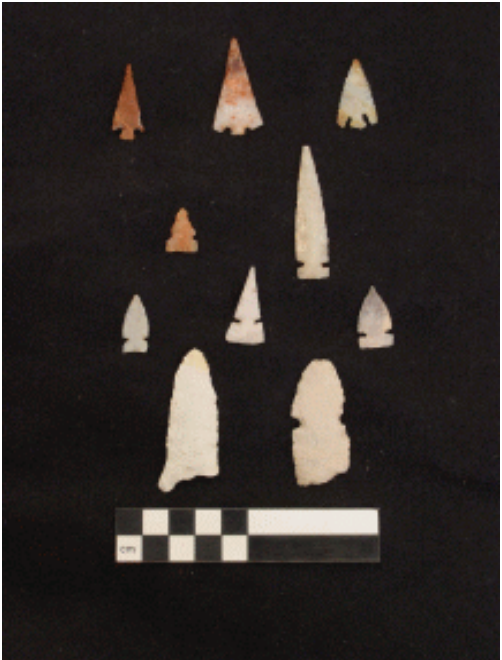

Figure 4.27. Projectile points.

Ground-Stone Artifacts

Tools in this group were used for grinding plant, animal, or mineral substances. Ground-stone tools are usually made of conglomerate, sandstone, silicified sandstone, or igneous rock. Although artifacts in this category may have been flaked or pecked during manufacture, the primary form of modification is grinding. Manos and metates, two very common ground-stone tools were used for grinding corn kernels into meal. Repeated use of these tools resulted in their surfaces becoming too smooth to effectively grind corn, so they would be periodically “sharpened,” or roughened, by being pecked with a peckingstone. Other ground-stone tools (especially abraders) were used for grinding bone or mineral, as would occur during the manufacture of certain ornaments.

Abrader (ABR). A coarse-textured, abrasive rock (usually sandstone or conglomerate) that has one or more ground surfaces, but lacks formal shaping (as from pecking or flaking). Abraders were usually made from pieces of tabular stone that fit comfortably in the hand, and their ground surfaces do not appear “sharpened” (that is, they are not pitted or otherwise roughened), Abraders could have been used “actively” for tanning hides, smoothing plaster, or grinding down rough edges on axes, or they could have been used “passively” for manufacturing beads, bone tubes, gaming pieces, and pendants. “Shaft-abrader” (Figure 3.52) are small tools that have a narrow groove ground into one surface. Such artifacts should be classified as abraders, and “shaft-abrader” should be entered in the comments. If an abrader has two ground surfaces, this should also be noted in the comments (Figure 4.28).

Basin Metate (BME). A metate with a concave, basin-shaped grinding area, produced by a circular grinding motion in the central area of the stone. Basin metates were used with one-hand manos. They may exhibit evidence of “sharpening,” or roughening with a peckingstone (Figure 4.29).

Indeterminate Ground-Stone (IGS). This individual artifact category is no longer used. Starting in 2001, fragments of indeterminate ground stone have been treated as bulk artifacts and cataloged as bulk indeterminate ground stone (BIG). Before 2001, each fragment of ground stone that could not be assigned to a more specific category was treated as an individual artifact and assigned a separate FS number. If grinding was observed on more than one surface of a piece of indeterminate ground stone, this was noted in the comments.

Mano (MAN). The active element of the two-piece grinding set that consisted of a mano and a metate. The mano was held in the hand and used to grind seeds (most often, corn kernels) and minerals against the metate, which rested on the ground. This generic category would be used only for mano fragments that cannot be identified more specifically as one- or two-handed manos (Figure 4.30). All manos share the following characteristics: a formal shape in a plan and cross section, on or more flat or convex surfaces that have been ground through use, and evidence of those surfaces having been roughened, or “sharpened” with a peckingstone.

Metate (MET). The passive element of the two-piece grinding set that consisted of a mano and a metate. The metate rested on the ground and was the stationary stone against which seeds (most often, corn kernels) and minerals were ground by the hand-held mano. The generic category should be used only for metate fragments that cannot be identified more specifically as basin, trough or slab metates (Figure 4.29). All metates have at least one flat-to-concave surface that has been both ground through use and roughened or “sharpened,” with a peckingstone.

Metate Rest (MER). Any object used to support one end of a metate to provide an angle suitable for grinding. A metate rest may be a rock, a chunk of hardened adobe, or any object strong enough to support the weight of a metate. Metate rests can only be identified in the field on the basis of context.

One-Hand Mano (OMA). A mano that was held in one hand and used in a circular grinding motion inside a basin metate. One-hand manos are usually round to oval in plan and oval in cross section. One or both surfaces of a one-hand mano will have been ground or ground and pecked (“sharpened”). The grinding surfaces are convex, the result of having been used on a basin metate. One-hand manos may be made from cobbles, sandstone, conglomerate, or other coarse material (Figure 4.30a,b).

Pestle (PES). A handheld pounding and grinding implement with a long, cylindrical shape and with grinding and battering wear on at least one end. The ends of pestles were used to pound and grind plant, animal, and mineral substances inside the cavity of a mortar. Pestles can be distinguished from manos by the location and type of modifications present. Pestles have grinding and battering damage on their ends, whereas manos will have grinding and pecking on their working surfaces. Pestles are usually made of tough materials such as silicified sandstone or igneous rock.

Slab Metate (SME). A metate with a flat or nearly flat grinding surface that spans or nearly spans the length and width. The grinding surface may be slightly concave in longitudinal cross section as the result of use, but it will be a flat (that is, not trough- or basin-shaped) in lateral cross section. Slab metates were used in conjunction with two-hand manos, and their grinding surfaces often exhibit evidence of having been roughened or “sharpened” with a peckingstone. The edges of slab metates usually were deliberately shaped (Figure 4.29b).

Stone Mortar (MTR). A grinding implement with a hollowed-out, steep-sided bowl suitable for use with a pestle. The bowl of a mortar should exhibit evidence of pounding and grinding. Mortars are usually made of a tough, coarse-grained material such as sandstone, conglomerate, or igneous rock (Figure 4.31).

Trough Metate (TME). A metate with a trough-shaped grinding area that runs parallel to the long axis of the stone. Trough depths range from fairly shallow to quite deep, depending on the length of time the metate was used and the thickness of the original stone. Trough

metates may be open at one or both ends. If the number of open ends can be determined, this should be noted in the comments. Trough metates were used in conjunction with two-hand manos, and their grinding surfaces often exhibit evidence of having been roughened or “sharpened” with a peckingstone (Figure 4.34).

Two-Hand Mano (TMA). Two-hand manos were held in both hands and moved with a back-and-forth motion along the long axis of a slab or trough metate. Two-hand manos were usually made from loaf-shaped blocks of sandstone, conglomerate, or silicified sandstone, and are formally shaped by pecking and flaking. Two-hand manos used with trough metates have one or two grinding surfaces that conform to the shape of the trough in which they were used. If this correspondence is apparent between spatially associated manos and metates, it should be noted in the comments. Two-hand manos used with slab metates have between one and four flat grinding surfaces. The ends of two-hand manos used with trough metates do not exhibit use wear. The grinding surfaces of both types of two-hand manos often show evidence of roughening or “sharpening,” with a peckingstone. Two-hand manos are usually rectangular in plan, and can be rectangular, triangular, trapezoidal, wedge-shaped, lozenge-shaped, or diamond-shaped in crosssection, depending on the types of metate they were used with and the way in which they were flipped and rotated during use (Figure 4.30a,c).



Figure 4.28. Abraders.



Figure 4.30a. *Top*, two-hand mano; *center*, two-hand mano fragment; *bottom*, one-hand mano.



Figure 4.30b. One-hand mano.



Figure 4.30c. Two-hand mano.

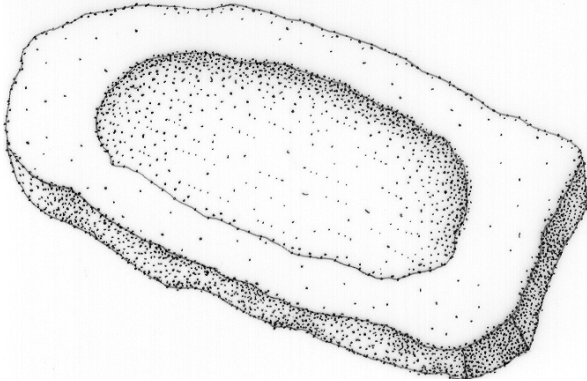

Figure 4.29a. Basin metate.

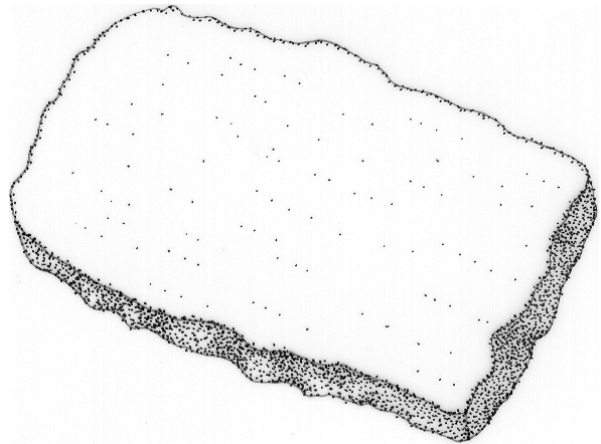

Figure 4.29b. Slab metate.

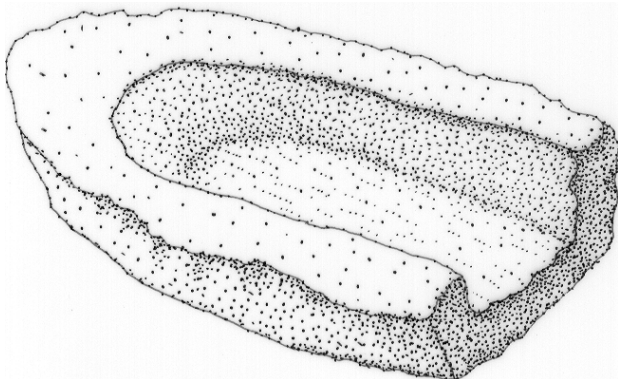

Figure 4.29c. Trough metate.



Figure 4.31. Cross-section view of a mortar.

Ornaments

Artifacts in this group are interpreted as items of personal adornment. They were made of a wide variety of stones, minerals, shell, pottery, and bone. As of 2001, and with the exception of beads, pendants, and gaming pieces, the lab no longer separates bone tools and ornaments from unmodified nonhuman bone during cataloging. These artifacts are now identified during faunal analysis and distinguished using an item number at that time.

Bead (BED). A small, round or cylindrical object with a hole that would have allowed it to be threaded on a cord with other similar objects to form a beaded string. Most beads are made from stone or bone. Stone drills were often used to drill from opposite sites toward the center of the object, which created a hole with a distinctive biconical shape. Beads also could have been made by someone taking advantage of (and possibly enhancing) a natural hole, such as that which occurs in a long-bone shaft. Use common sense when distinguishing beads from pendants. To distinguish a hollow bone bead from a hollow bone tube, use the diameter:length ratio. If the ratio is 1 or more (that is, the diameter is equal to or larger than the length), classify the object as a bead; if it is less (that is, the diameter is less than the length), classify it as a tube (Figure 4.32).

Bracelet (BRA). A deliberately modified circular or oval band large enough to be worn on the wrist or ankle. Bracelets may consist of open or closed bands. They may be made of a variety of materials, but *Glycymeris* shell is the most common.

Pendant (PEN). A small, flat, deliberately shaped object with a hole near an edge that would have permitted suspension from a string or cord. Stone drills were often used to drill from opposite sides toward the center of the object, which created a hole with a distinctive biconical shape. Pendants were fashioned from a variety of materials, including stone, bone, pottery, and shell. Pottery pendants usually were not shaped or polished on their flat surfaces, but pendants of other materials often were. Items with incompletely drilled holes may be classified as pendants if the analyst is confident that a pendant was the desired end product. Objects with shaped surfaces and sides but lacking evidence of a hole for stringing should be classified as other modified stone, even though it is possible that some of these were pendant blanks (Figure 4.33).

Ring (RIN). A deliberately modified circular band small enough to be worn on the finger. Rings may be made of a variety of materials, including stone, bone, and shell (Figure 4.34).

Tube (TUB). A deliberately modified cylindrical object with a hollow center and a diameter:length ratio that is less than 1 (the diameter is less than the length; see *Bead*, above). Tubes are almost always made of animal long-bone shafts in whose natural marrow cavities were cleaned and enlarged (Figure 4.35).



Figure 4.32. Beads.



Figure 4.33. Pendants.



Figure 4.34. Ring.



Figure 4.35. Tube.

Other Artifacts

Basketry (BAS). Any artifact woven, sewn, or assembled without the aid of a loom to form a rigid or semirigid container. In the northern Southwest, such artifacts are typically made of yucca, willow, juniper bark, and/or skunkbush fibers.

Cylinder (CYL). A solid cylindrical object that appears to have been deliberately shaped during manufacture or incidentally shaped through use. Cylinders are usually made of stone or mineral, but they can also be made of other suitable materials, such as wood. Items that appear to be naturally cylindrical are not considered artifacts (Figure 4.36).

Effigy (EFF). An object shaped in the form of a human or animal being. Effigies can be made of a variety of materials, including stone, mineral, pottery, wood, and unfired clay.

Not Collected (NCO). This category is used for any type of artifact (except human bone) or ecofact that has been mapped and described in the field but was not collected because of its size, the context in which it was found, lack of modification, etc.

Other (OTH). Any artifact that does not fall into any other artifact category, usually because it is composed of a rare material (for example, hair), or is made of multiple materials (for example, a *paho* that has both bone and vegetal components). Artifacts classified as "other" may be treated either as bulk artifacts (for example, hair) or as individual artifacts (for example, composite artifacts), as determined on a case-by-case basis. All artifacts classified as "Other" should be described thoroughly in the comments.

Other Modified Vegetal (OMV). Any vegetal (plant) material that has been modified by humans, but that does not fall into any of the more specific artifact categories listed here. Burning resulting from use as fuel is not considered modification. Yucca cordage is included in this category. As of 2001, the lab no longer inspects the contents of vegetal samples for modified objects. It is assumed that any such objects will be identified in the course of archaeo-botanical analysis or identified in the field and collected separately.

Petroglyph (PTG). A design or image pecked and/or ground into a stone, usually sandstone. Building stones with petroglyphs are collected and cataloged as this artifact type if they have fallen from their original locations. Petroglyphs on stones that are still incorporated into standing architecture and pecked and/or ground into bedrock are considered ecofacts, and are recorded in the field.

Textile (TEX). In contrast to basketry, textiles are relatively flexible and may or may not form a container. Textiles are made with or without a loom, but are characterized by the use of warps and wefts (as noted above, items such as cordage, which does not exhibit warp and weft, is recorded as Other Modified). Artifacts assigned to this category include cotton cloth, netting, fur and feather cloth, woven belts, bands, tumplines, sashes, clothing, and sandals. Yucca, cotton, and dogbane were materials used often in the production of ancient textiles of the northern Southwest. All textiles should be described thoroughly in the comments.

Unmodified Artifact (UNK). This category has not been used since 1991. Before then, some unmodified objects thought to have been brought to the site by humans were cataloged as this artifact type. Since 1991, all such items have been classified as mineral samples.

Void (VOI). This category is assigned in the lab if an item was given a point-location (PL) number, mapped, and identified as an artifact by the field crew, but was later found to be an unmodified object when it was examined in the lab. Because it was mapped and documented in the field, the "void" designation is used to maintain a paper trail for that object and for reconciling field maps with lab records, even though the object itself was discarded.



Figure 4.36. Cylinder.

Other Pottery Artifacts

The most common objects of pottery found at ancestral Pueblo sites are sherds –that is, pieces of broken vessels—and most sherds were simply discarded when their parent vessels broke. However some pottery objects were never parts of vessels, and some pottery sherds were “recycled” for use as tools or other implements. The categories listed below are used to catalog such artifacts.

Modified Sherd (MOS). A sherd that has been modified, usually by flaking and/or grinding, on at least one edge but not on all edges. The modification may be deliberate, incidental, or both, but it should have occurred *after* the parent vessel broke into sherds. Sherds with wear related to the use of the parent vessel are not classified as modified sherds (for example, the rim of a ladle). Many modified sherds were modified as a result of their being used to shape wet clay during pottery manufacture (Figure 4.37).

Other Ceramic Artifact (OCA). An object that was made of fired, tempered clay, but that does not appear to have derived from a pottery vessel. “Ceramic” is another term for pottery.

Shaped Sherd (SHS). A sherd that has been modified, usually by flaking and/or grinding, on all edges. These items are usually small and round, triangular, or rectangular in shape. Many shaped sherds probably represent pendants in various stages of manufacture. A small shaped sherd with a hole near one edge is classified as a pendant (Figure 4.48).



Figure 4.37. Modified sherd.



Figure 4.38. Shaped sherd.

Other Stone Artifacts

Modified Cobble (MCO). Before 1998, this category was used to catalog cobbles that had been modified deliberately or incidentally through use, but that could not be assigned to a more specific artifact category. Since 1998, all such objects have been cataloged as *other modified stone (OMS)*.

Other Modified Mineral (OMM). Prior to 1998, this category was assigned pieces of mineral that had been modified, but could not be assigned to a more specific artifact category. Materials classified as "mineral" included, but were not restricted to: gypsum, calcite, barite, hematite, caliche, and pigment. As of 1998, we catalog all such objects as *Other Modified Stone/Mineral (OMS)*.

Other Modified Stone/Mineral (OMS). A stone or mineral that has been modified, but that does not conform to any of the definitions listed here. This designation is often applied to extremely small stone tool fragments, but also may be used to describe whole or nearly whole artifacts that simply do not fit into any of the more specific categories. Each piece should be described in the comments.

Sandal Last (SAL). A thin, flat, deliberately modified stone roughly the size and shape of a (large) sandal. Sandal lasts often appear to have been shaped by both flaking and grinding, and they usually polished to a smooth, fine finish.

Stone Disk (STD). A flat, round stone was been deliberately shaped by flaking, grinding, or pecking. Stone disks were most often used as lids for pottery vessels. (Figure 4.39).

Unmodified Cobble (UCO). Before 1989, this category was used to catalog cobbles that exhibited no signs of deliberate or incidental modification. It is assumed that such objects were carried to the site by humans because the materials they consist of do not occur widely in the local surface geology and it is known that such materials were used by the ancestral Pueblo people. Since 1989, all such objects have been cataloged as mineral/stone samples (MIN).

Unmodified Stone (UST). Before 1998, this category was assigned to stones, other than cobbles and sandstone building blocks, that exhibited no signs of deliberate or incidental modification. In many cases, such objects may have been carried to the site by humans because the materials they consist of do not occur widely in local surface geology and it is known that such materials were used by the site inhabitants. Since 1998, all such objects have been cataloged as *mineral/stone samples* (MIN).



Figure 4.39. Stone disk.

Shell Artifacts

Other Modified Shell (MSH). A shell or shell fragment that has been modified by a human, but that does not fall into any of the more specific artifact categories such as pendant or bead.

Bone Artifacts

Bone artifacts are tools made from nonhuman bone. Prior to 2001, bone tools and bone ornaments were separated from the unmodified nonhuman bone, and each was cataloged as a separate item. Since 2001, modified bone tools have been cataloged with “bulk” unmodified nonhuman bone, so these artifacts now are usually identified and described during faunal analysis. Cut marks,

splintering, fracturing, and burning do not constitute modification for the purposes of the definitions in this section. Bone ornaments *are not* cataloged with the bulk nonhuman bone.

Antler Tool (ANT). Any antler or antler fragment that shows evidence of human modification or use wear related to tool manufacturing or use.

Awl (AWL). A bone tool, usually made from a long-bone shaft, with a deliberately fashioned point on one end. Awls may or may not have holes in their butt ends, but when they do, they are distinguished from needles on the basis of size and shape: awls are larger and frequently have blunter, less-tapered tips.

Gaming Piece (GAP). A small, flat, deliberately shaped piece of bone, usually round or oval, often with an incised pattern on one or both surfaces (Figure 4.40.).

Needle (NED). A deliberately shaped bone tool with a thin, tapering shaft, fine point, and a hole in the end opposite the tip. A fragment that does not include the end with the hole may be classified as a needle if the portion present clearly conforms to other aspects of this definition.

Other Modified Bone (OMB). Any bone or bone fragment that shows evidence of shaping related to tool manufacture or use, but that cannot be assigned to one of the more specific tool types listed here.

Scraper (SCR). A bone tool, usually made from the long bone of a large animal, with a deliberately rounded or curved distal end and a beveled edge.



Figure 4.40. Gaming piece.

Chapter 5

Pottery Type Definitions

This chapter presents the ware and type definitions currently used by Crow Canyon archaeologists for pottery sherd and vessel analysis. This chapter is intended primarily for researchers, participants, and students working with Crow Canyon pottery analysis data, which have appeared in numerous books, journal articles, and Internet-based research publications produced over the years by the research staff. For more information on how to identify pottery sherds in the field or during laboratory analysis, consult Chapter 6: Pottery Analysis Procedures.

The pottery typology described here was first used in February 1989 (Crow Canyon Archaeological Center, 1990*1). Although the type names and type codes have not changed since that time, definitions of several types have evolved slightly with the benefit of experience. Unless otherwise noted, the pottery types defined in this guide are considered "local"; that is, they are believed to have been manufactured in the Mesa Verde, or northern San Juan, region. The pottery descriptions are organized chronologically within each ware category, beginning with mud ware then continuing with the local gray, white, and red ware types. Descriptions of nonlocal wares are provided at the end of the chapter. Many of the definitions are based on descriptions of traditional pottery types published in Breternitz et al. (1974*1) and in Wilson and Blinman (1995*1). In addition, definitions of several more-general "grouped" types (for example, Pueblo II White Painted and Pueblo III White Painted) are provided; these categories were created by Crow Canyon researchers to accommodate sherds that do not fit easily into previously recognized traditional categories. Date ranges for the types described below are taken in part from Wilson and Blinman (1999*2). However, the date ranges of several types have recently been revised as a result of a joint effort by Washington State University and the Crow Canyon Archaeological Center to compile pottery-assemblage data for excavated sites of known age in southwestern Colorado.

When using this guide, keep in mind that, although we have attempted to minimize subjectivity, pottery analysis, is an inherently subjective enterprise. There are two reasons for this. First, when classifying pottery, we examine numerous attributes, including painted design layouts and design elements, paint type, paste and temper characteristics, surface treatment, thickness, and rim form. These attributes are correlated through time, but nevertheless evolved somewhat independently. Thus, it is not possible to define a type using attributes that covary without exception. This document therefore contains *descriptions* of pottery types that have been dated to various time spans, rather than *definitions* in the strict sense of "necessary and sufficient criteria." Pottery types were developed to help researchers estimate the age of archaeological deposits. During pottery sherd classification, the question that is really being answered for each sherd is, What is the likely time span during which this sherd was deposited at the site? Because ancient pottery vessels were made in the context of an ongoing, creative art tradition, and not for the purpose of providing archaeologists with dating information, this question is more often answered through subjective pattern-matching than through the application of objective definitions.

Second, sherd analysis at Crow Canyon is typically performed by numerous individuals, both professional and nonprofessional, in educational programs and as part of our regular research effort. The laboratory staff makes every effort to check the work of our participants, volunteers, interns, and fellow staff members. But because so many different people classify pottery in Crow Canyon's lab, some interobserver variation is unavoidable.

The following sections provide definitions of key terms that are used throughout this chapter and Chapter 6, and descriptions of each pottery type we recognize within each ware of the Mesa Verde tradition in our basic pottery analysis. Following these sections are descriptions of type categories we use for vessels and sherds of other and unknown traditions.

Definitions of Terms

A number of technical terms are used in the following descriptions of pottery wares and types. The following glossary provides brief definitions of many of these terms:

active background—a design characteristic that occurs when the unpainted area within a black-on-white pottery design forms a distinct pattern that differs in shape from the painted area.

attribute—also called a variable. A particular characteristic of design, style or form. Each attribute observed on pottery can occur in more than one state.

paste—the mixture of clay, temper, and water used to make a pottery vessel.

slip—a thin wash of clay applied to the surface of a pottery vessel after forming, when the body clay has dried leather-hard.

polish—created by rubbing a smooth, hard stone over a pottery vessel surface after it has dried but before it is painted. Polishing produces a smooth, lustrous surface.

temper—aplastic material that is mixed with clay and water during paste preparation. Tempered paste does not shrink as much as pure clay when it dries, and is also more resistant to breakage from thermal and mechanical stress after firing .

tradition—the geographic region of postulated origin for a series of pottery wares and types. In the four corners area, pottery of a specific tradition is usually distinguished from other traditions by raw material attributes such as temper, paint, paste, and slip clay. The local pottery analyzed in our lab is of the Mesa Verde, or Northern San Juan, tradition.

true background—a design characteristic that occurs when the unpainted area in a black-on-white design serves as the “canvas” on which the design is applied. The unpainted area does not make a distinct pattern of its own, and is merely the remainder of the field after painting.

type—the characteristic pottery of a particular ware and tradition during a specific period of

time. Each type is defined on the basis of a cluster of attributes.

ware—pottery with a specific surface treatment that is characteristic of a particular tradition over a long period of time. Each ware encompasses a series of chronologically-specific types, and groups of wares comprise a tradition. Mesa Verde tradition pottery occurs as mud ware, gray ware, red ware, and white ware.

Mud Ware

Basketmaker Mud Ware, BMW (A.D. 575–700). This ware represents the earliest pottery manufactured in the northern Southwest (see Morris 1927*1). It is identified on the basis of vegetal fiber temper, and basket impressions are sometimes visible on the exterior surfaces of the vessels. Basketmaker Mud Ware sherds range in color from reddish brown to gray brown, and they are usually very soft and easily broken. This is probably due to the fact that the Basketmaker Mud Ware was poorly fired—the temperature during the firing was low and/or the length of the firing was short. Thus, mud ware sherds range in color from reddish brown to gray brown, and they are usually very soft and easily broken. Like gray ware sherds, Basketmaker Mud Ware sherds lack slip, polish, and paint; nevertheless, mud ware is very distinct from the gray ware types described below.

Local Gray Ware Types

Gray ware sherds are not slipped, polished, or painted. Wilson and Blinman (1995*1: 38-39) describe a local gray ware type, Twin-Trees Gray, that has limited surface polish, but this type is not used in the Crow Canyon analysis system. Gray ware sherds are from vessels that were fired in a neutral atmosphere, and they tend to have coarser pastes than either white ware or red ware sherds. Crushed igneous rock is the most common temper in gray ware pottery manufactured in the Sand Canyon locality. It is usually coarse and often protrudes from the sherd surface. Crushed conglomerate sandstone temper characterizes the gray ware pottery produced in the area between Montezuma Creek and Yellow Jacket Creek because igneous rock was not available in this area (Wilson 1991*1: 5).

Two categories of gray ware—plain and corrugated—are recognized on the basis of surface treatment, particularly as observed on jar forms. All gray ware pottery was made by coiling, and the coil junctions on the interior surfaces of all vessels were obliterated by scraping. However, coil junctions on the exterior surfaces of vessels were treated differently through time. Plain gray ware pottery was made before approximately A.D. 980. The coil junctions on the exterior surfaces of plain gray jars were scraped smooth from at least the vessel base to the vessel shoulder; from the shoulder to the rim, the coils were either scraped smooth or left exposed but not further manipulated. It is the exterior surface treatment of this portion of the vessel—that is, the neck—that distinguishes the plain gray ware types from one another. After approximately A.D. 980, the exterior coil junctions on gray ware jars were left exposed from base to rim, and the coils were indented, or “corrugated,” to produce a distinctive textured surface. These

patterned indentations were created when the potter pressed a finger or tool into the clay coils at uniform intervals as the vessel was being formed.

The tempering agents used in local gray ware pastes (crushed igneous rock and crushed conglomerate sandstone) are indistinguishable to the naked eye from those used in other parts of the Southwest, including the San Juan River basin and northeastern Arizona. Thus, it is often impossible to distinguish local from nonlocal gray ware sherds. As a result, we assume that all gray ware sherds lacking definite evidence of nonlocal manufacture derive from locally made gray ware vessels. We identify Chuska Gray Ware sherds when fragments of trachyte or biotite mica are noted in gray ware paste during analysis. Using a binocular microscope, we also conduct temper analysis on a sample of sherds from each site using a binocular microscope to estimate the frequency of nonlocal sherds in each assemblage (see Chapter 7).

Chapin Gray, CGR (A.D. 600–980). This type refers to plain gray ware vessels on which the coils have been scraped smooth over the entire exterior surface. Because neckbanded vessels were scraped smooth below the shoulder, Chapin Gray sherds can be distinguished from sherds of other plain gray types only if they are from the neck or rim of the vessel (Figure 5.1). Also, a neck or rim sherd must be large enough for the analyst to be certain that it is from a vessel whose neck has been scraped smooth (that is, it must be larger than the width of a neckband and larger than the width of the uncorrugated coil that forms the rim of a corrugated jar). Because relatively few plain gray sherds—and none from below the vessel shoulder—meet all these criteria, most are categorized as Indeterminate Local Gray (see type description below).

Chapin Gray vessel forms include wide-mouth cooking jars, storage jars, ollas, ladles, bowls, and seed jars. Chapin Gray is analogous to Lino Gray of the Cibola and Kayenta traditions, Rosa Gray of the upper San Juan tradition, and Bennett Gray of the Chuska tradition.

Moccasin Gray, MGR (A.D. 800–980). Moccasin Gray vessels are distinguished by relatively wide, flat, nonoverlapping coils, or “neckbands,” on the exterior surface, from approximately the shoulder to the rim; from the shoulder to the base, the exterior surface was scraped smooth. Only rim or neck sherds that preserve evidence of unobliterated coils fitting the foregoing description can be classified as Moccasin Gray (Figures 5.2 and 5.4). Sherds below the neck cannot be distinguished from those that derive from the lower halves of Chapin Gray, Mancos Gray, and Indeterminate Neckbanded Gray vessels and therefore are categorized as Indeterminate Local Gray.

Moccasin Gray vessels are predominantly wide-mouth cooking or storage jars, but pitchers of this type are also found. Ollas are extremely rare, and other vessel forms are nonexistent. Moccasin Gray sherds have been identified at sites dating from as early as A.D. 725, but they are not consistently present at sites dating from before A.D. 800. Moccasin Gray was the dominant gray ware type between A.D. 800 and 920, and it persisted through at least A.D. 980.

Mancos Gray, AGR (A.D. 880–1060). Mancos Gray vessels are distinguished by relatively narrow, rounded, and overlapping neckband coils from approximately the shoulder to

the rim. From the shoulder to the base, the exterior surface was scraped smooth. Only rim or neck sherds that preserve evidence of unobliterated coils fitting the foregoing description can be classified as Mancos Gray (Figures 5.3 and 5.4). Sherds from below the neck cannot be distinguished from those that derive from the lower halves of Chapin Gray, Moccasin Gray, and Indeterminate Neckbanded Gray vessels and therefore are categorized as Indeterminate Local Gray.

The predominant vessel form of this type is a wide-mouth cooking and storage jar, but pitchers of this type are also found. Mancos Gray appears in sites dating from as early as A.D. 840. It was consistently present after A.D. 860, was the dominant gray ware type between A.D. 920 and 980, and persisted through the early decades of the eleventh century. Mancos Gray is analogous to Kana'a Gray and most Coconino Gray of the Kayenta and Cibola traditions and to Gray Hills Banded, some Tocito Gray, and some Captain Tom Corrugated of the Chuska tradition.

Indeterminate Neckbanded Gray, ING (A.D. 800–1060). This category is for neckbanded sherds that cannot be typed more specifically as Mancos Gray or Moccasin Gray because (1) only one wide band is present, making it impossible to assess the degree of overlap between bands, or (2) the configuration of the coils or bands is transitional between the two types.

Indeterminate Local Gray, GRA (A.D. 575–1020). This type includes (1) plain gray body sherds that are not from the rim or neck of a vessel, (2) plain gray rim and/or neck sherds that are too small for the analyst to determine whether they came from a neckbanded, corrugated, or plain gray vessel, and (3) plain gray rim and/or neck sherds that have ambiguous characteristics (for example, a sherd on which the neckbands have been only partly scraped over) (Figure 5.5).

Mancos Corrugated Gray, MRG (A.D. 920–1180). This type is used for rim sherds only. Mancos Corrugated Gray rim sherds are distinguished from Mesa Verde Corrugated Gray rim sherds on the basis of the degree of outward flare of the rim, called “rim eversion” (Figure 5.6, 5.7, and 5.8). To determine the degree of rim eversion, the analyst orients the sherd so that the rim is level, as it would have appeared when part of a whole vessel. If the rim is relatively vertical or only slightly flared (less than 30 degrees from vertical), the sherd is classified as Mancos Corrugated Gray (Figure 6.14). Rim sherds for which the degree of eversion cannot be determined and all corrugated body sherds are classified as Indeterminate Local Corrugated Gray.

The predominant vessel form of this pottery type is a wide-mouth cooking and storage jar (Figure 5.8). Mancos Corrugated Gray is found at sites that date from as early as A.D. 920. It was consistently present after A.D. 980, was the dominant gray ware between A.D. 1020 and 1100, and persisted through the middle decades of the twelfth century.

Mesa Verde Corrugated Gray, VRG (A.D. 1100–1280). This type is used for rim sherds only. The rims of Mesa Verde Corrugated Gray vessels are more flared than the rims of Mancos Corrugated Gray vessels (Figures 5.9 and 5.10). To determine the degree of rim

eversion, the analyst orients the sherd so that the rim is level, as it would have appeared when part of a whole vessel. If the rim eversion is greater than or equal to 30 degrees, the sherd is classified as Mesa Verde Corrugated. Rim sherds for which the degree of eversion cannot be determined and all corrugated body sherds are classified as Indeterminate Local Corrugated Gray.

The predominant vessel form of Mesa Verde Corrugated Gray is a wide-mouth cooking and storage jar (Figure 5.11). This pottery type is found at sites dating from as early as A.D. 1060, was consistently present after A.D. 1100, and was the dominant gray ware type between A.D. 1140 and 1280.

Wilson and Blinman (1995*1:43) subdivide what Crow Canyon researchers categorize as Mesa Verde Corrugated Gray into two types: Dolores Corrugated (rim eversion between 30 and 55 degrees) and their version of Mesa Verde Corrugated (rim eversion greater than 55 degrees). Wilson and Blinman (1995*1:43) argue that Dolores Corrugated was produced from approximately A.D. 1050 to 1200. Although distinguishing between Dolores and Mesa Verde Corrugated during analysis obviously can help researchers refine their date estimates for sites, we do not attempt to identify the former in our system, because it would be difficult to ensure consistent analysis by participants in the Center's research and education programs. Therefore, the time span assigned to Mesa Verde Corrugated in Crow Canyon's sherd analysis is longer than the date range for this type as defined by Wilson and Blinman.

Mummy Lake Gray, MLG (A.D. 1050–1200). This type is used for rim sherds only. The distinctive feature of Mummy Lake Gray is a single exposed band encircling the rim, which is usually flared (Figure 5.12). The remainder of the vessel consists of corrugated coils that were scraped over, obliterating most or all of the corrugated texture. Mummy Lake Gray vessels and sherds are extremely rare. Wilson and Blinman (1995*1:43) state that Mummy Lake Gray has been reported from contexts dating from as early as A.D. 700, they warn that the pottery in question is probably misidentified Moccasin Gray and Mancos Gray. The time range for Mummy Lake Gray is thought to be A.D. 1050 through 1200.

Indeterminate Local Corrugated Gray, CRG (A.D. 920–1280). Sherds are assigned to Indeterminate Local Corrugated Gray if (1) they are corrugated rim sherds that are too small or too irregular for the analyst to assess degree of rim eversion or (2) they are corrugated body sherds (Figure 5.13).

Local White Ware Types

Most decorated pottery manufactured in the northern San Juan region was white ware, except during the Pueblo I period, when red ware was more common. Overall, the frequency of white ware pottery increased from the Basketmaker III period through the Pueblo III period (Wilson and Blinman 1991*1: 16).

White ware sherds exhibit slip, polish, and paint or any combination of these. White ware vessels were fired in a neutral atmosphere, resulting in a gray to white surface color. The majority of white ware vessels have designs executed in mineral or organic paint, but many white ware sherds derive from unpainted portions of such vessels, especially jars. *Slip* refers to the solution of fine, watery clay that was applied to the surface of a partially dried vessel; it changed the color of the vessel and created a more uniform surface for painting. *Polish* refers to the sheen or luster produced when a partially dry vessel was rubbed with a hard, smooth stone to compress the clay surface and flatten out irregularities. Polish is seen primarily on slipped vessel surfaces, but unslipped surfaces were sometimes polished as well.

The pastes from which “early” (pre–A.D. 920) white ware vessels were made are relatively coarse and do not differ appreciably from the pastes of contemporaneous gray ware vessels. The earliest white ware vessels were not usually slipped or polished, and sherds from these would appear identical to contemporaneous plain gray sherds were it not for the presence of painted designs. Vessels made somewhat later were more often slipped and polished, but they were not usually as well finished as vessels made after A.D. 920. Early white ware vessels were commonly tempered with crushed igneous rock or sand, and they had relatively thin walls compared with vessels of later types (especially McElmo Black-on-white and Mesa Verde Black-on-white).

“Late” (post–A.D. 920) white ware vessels were made from finer pastes, and their surfaces were more finely finished than those of either earlier white ware vessels or the contemporaneous gray ware vessels. They were usually slipped and polished, especially on decorated surfaces (that is bowl interiors and jar exteriors), although the amount of polishing and the thickness of the slip varies. Vessel thickness is also variable: The walls of Cortez Black-on-white vessels are often very thin; the walls of Mancos Black-on-white vessels are thicker; and the walls of vessels of the latest types (McElmo Black-on-white, Mesa Verde Black-on-white, and Pueblo III White Painted) can be quite thick (greater than 6 cm). The pastes of late white ware vessels often were tempered with crushed sherd, but crushed igneous rock, crushed sandstone and sand were also used.

The attributes that define white ware types varied somewhat independently through time. To aid the analyst in assigning a white ware sherd to a pottery type, we provide attribute lists in the following type definitions.

Chapin Black-on-white, CBW (A.D. 575–880): Found at sites that date from as early as A.D. 575, Chapin Black-on-white is the oldest decorated white ware type in the Mesa

Verde region (Figures 5.14 and 5.15). It was the only decorated white ware manufactured through the seventh and eighth centuries. Sherds of this type are rare at sites occupied after A.D. 800, but they are found sporadically in sites occupied up to A.D. 880. White ware sherds dating from the ninth century often show characteristics that are intermediate between Chapin Black-on-White and Piedra Black-on-white. The range of design elements of Chapin Black-on-white is similar to that documented for Lino Black-on-white of the Kayenta tradition, La Plata Black-on-white of the Cibola tradition, Crozier Black-on-white of the Chuska tradition, and Rosa Black-on-white of the upper San Juan tradition.

Paste: Medium to coarse; similar to that of contemporaneous local gray ware.

Temper: Crushed igneous rock or sand.

Surface Treatment: Vessels were scraped and rubbed, perhaps with water, but they were never slipped and rarely polished. Temper particles can often be seen protruding from vessel surfaces. Cracks radiating out from these temper particles are the result of the clay shrinking as it dried prior to being fired. Vessel exteriors were sometimes decorated with a “fugitive red” pigment consisting of an iron oxide solution that was applied after the vessel was fired.

Thickness: Relatively thin compared with the latest types (McElmo Black-on-white, Mesa Verde Black-on-white, and Pueblo III White Painted).

Painted Design:

Paint Type—Usually iron or manganese mineral paint, although glaze and organic pigments were also used. Organic paint is found frequently on sherds found in southeastern Utah. Glaze paint is found on some sherds in assemblages from the Animas and La Plata river valleys; we classify such pottery as a nonlocal type, Rosa Black-on-white.

Design—Usually sparse; simple, and poorly executed, painted designs float on a true background. Most designs on Chapin Black-on-white sherds closely mimic those found on contemporaneous coiled baskets. Designs on bowls often radiate upward and outward from the center toward the rim. Sometimes the decorated areas are outlined, and the space inside is filled with simple design elements. Common design elements include, but are not restricted to, the following: dots, Z's, S's, triangles, and various forms of tick marks. Bowl exteriors are not usually painted.

Rim: Tapered. Usually undecorated, but if decorations is present, it typically consists of a single solid line.

Forms: Bowls are most common, although seed jars, ollas, and effigy vessels are also found.

Piedra Black-on-white, PBW (A.D. 800–920). Piedra Black-on-white is the dominant white ware type between A.D. 800 and 920 (Figures 5.16 and 5.17). However, Piedra Black-on-white sherds generally make up only a small proportion of an assemblage, and they are usually less common than sherds of the contemporaneous red ware types, Abajo Red-on-orange and Bluff Black-on-red. Piedra Black-on-white shares some characteristics with contemporaneous types in other regions, including Kana'a Black-on-white of the Kayenta tradition, Drolet Black-on-white of the Chuska tradition, and Kiatuthlana Black-on-white of the Cibola tradition.

Paste: Medium.

Temper: Crushed igneous rock or sand.

Surface Treatment: Variable, but distinguished from Chapin Black-on-white by the common occurrence of scraping and polishing on painted surfaces (even though the polish may be erratic). Early Piedra Black-on-white sherds are unslipped, but the incidence of slipping increases through time. Fugitive red coatings are rare. Surfaces were not prepared as carefully or as consistently as they were on later pottery types.

Thickness: Relatively thin compared with the latest types (McElmo Black-on-white, Mesa Verde Black-on-white, and Pueblo III White Painted).

Painted Design:

Paint Type - Mineral, carbon, or mixed mineral and carbon.

Design - There is more sophistication in painted designs than on Chapin Black-on-white vessels, although the designs are still relatively crude compared with those seen on later types. Bowl interiors are often decorated with parallel lines that drop down from the rim and extend across the vessel surface. The exterior surfaces of bowls are rarely painted. Jars often have parallel lines that wrap around the body. The parallel lines are relatively wide and are spaced fairly close together. The space between the lines is roughly one to two times the width of the lines themselves. Flags, tick marks, and triangles are commonly appended to outer lines.

Rim: Tapered. Often decorated with a solid painted line.

Forms: Bowls are the predominate form, but jars, gourd jars, pitchers, and ladles are also present.

Early White Painted, RBW (A.D. 575–920). The Early White Painted type includes sherds that could be either Chapin Black-on-white or Piedra Black-on-white. This type is used when a sherd is too small or lacks enough design to be assigned to a more specific type but is thought on the basis of its paste, temper, and surface treatment to have been made during the Basketmaker III or Pueblo I periods.

Paste: Medium to coarse.

Temper: Usually crushed igneous rock or sand.

Surface Treatment: Variable. Vessel surfaces were rarely slipped, but the exterior of jars and the interior of bowls were often polished, slightly as if the surfaces were rubbed with a little water or a wet cloth. Temper particles can often be seen protruding from vessel surfaces. Cracks radiating out from these temper particles are the result of the clay shrinking as it dried prior to being fired. Slip and/or polish when present, are relatively crude.

Thickness: Relatively thin.

Painted Design:

Paint Type - Mineral, carbon, or mixed mineral and carbon.

Design - There usually is not enough design present on the sherd for the analyst to identify specific layouts and design elements, but what is present could be from either a Chapin Black-on-white vessel or a Piedra Black-on-white vessel. The exterior surfaces of bowls are usually not painted.

Rim: Tapered. May or may not be decorated; if decorated, it is painted with a single, solid line.

Forms: Bowls are the most common form, but seed jars, ollas, gourd jars, pitchers, ladles and effigy vessels are also present.

Early White Unpainted, EWU (A.D. 575–920). This category is used to describe sherds that are white ware and are believed on the basis of paste and temper characteristics to be from vessels made before A.D. 920. A sherd is placed in the Early White Unpainted category when all three of the following conditions are met: (1) the presence of polish indicates that the sherd is a white ware; (2) the medium to coarse paste tempered with crushed igneous rock or sand indicates that the sherd is from a vessel that predates A.D. 920; and (3) no paint is visible on the sherd. Relatively thin, *tapered* rim sherds with little or no slip or polish are also placed in this grouped type.

Paste: Medium to coarse.

Temper: Usually crushed igneous rock or sand.

Surface Treatment: Vessel surfaces were rarely slipped, but the exterior of jars and the interior of bowls were often polished, slightly as if the surfaces were rubbed with a little water or a wet cloth. Sherds may or may not have been slipped but are virtually always polished. If slip is present, it is thin and “washy” compared with the thick, crackled slips of late white ware sherds. Temper particles can often be seen protruding from vessel surfaces. Cracks radiating out from these temper particles are the result of the clay shrinking as it dried prior to being fired.

Thickness: Relatively thin.

Rim: Tapered.

Forms: Bowls are the most common form, but seed jars, ollas, gourd jars, pitchers, ladles and effigy vessels are also present.

Cortez Black-on-white, ZBW (A.D. 920–1060). The combination of surface treatment and design makes Cortez Black-on-white (Figures 5.18 and 5.19) a distinctive type when compared with the continuous variation in the earlier Chapin Black-on-white and Piedra Black-on-white types and in the later Mancos, McElmo, and Mesa Verde black-on-white types. Our best data indicate that this pottery type first occurred in low frequencies at sites dating from A.D. 880 and 920 and that it became the dominant white ware type in sites dating from A.D. 920 through 980. It began to be replaced by Mancos Black-on-white around A.D. 980, with complete replacement by A.D. 1060. Cortez Black-on-white design styles share characteristics with Naschitti and Newcomb black-on-white of the Chuska tradition; Red Mesa black-on-white of the Cibola tradition and Arboles black-on-white of the Upper San Juan tradition. Some design elements are shared with Kiatuthlana black-on-white of the Cibola tradition, Black Mesa and Kana'a black-on-white of the Kayenta tradition.

Paste: Medium to fine.

Temper: Primarily crushed igneous rock.

Surface Treatment: Painted surfaces are usually covered with a bright white slip and are well polished. Bowl exteriors are often unslipped and unpolished, and they often have an undulating appearance, the result of their having been cradled in the hands as their interior surfaces were scraped during manufacture.

Thickness: Relatively thin; in general, the thinnest of all white ware types in the Mesa Verde region.

Painted Design:

Paint Type - Almost always mineral.

Design - Vessel surfaces, especially bowl interiors, tend to be divided into thirds or quarters, within which complex, fluid patterns are repeated. Linear patterns with appended motifs similar to Piedra Black-on-white designs are still evident, but the lines on Cortez Black-on-white sherds are generally thinner and more widely spaced, and they are often curvilinear. The exterior surfaces of bowls are usually unpainted, and jar exteriors are commonly decorated with band designs. Common design elements include, but are not restricted to, dots, ticks, flags, rickrack, scrolls, interlocking scrolls, stepped triangles, squiggles, squiggle hachure, and right triangles with ticks along the hypotenuse.

Rim: Rounded to very tapered; often decorated with a solid painted line.

Forms: A wide range, including bowls, jars, seed jars, and ladles.

Mancos Black-on-white, MBW (A.D. 920–1180). Mancos Black-on-white encompasses more variation in both technology and design attributes than any other Mesa Verde White Ware type (Figures 5.20–5.22). Mancos Black-on-white first appears in sites dating from the middle decades of the tenth century, is the most common white ware type in sites dating from A.D. 1020 to 1180, and is occasionally found in contexts dating from the A.D. 1200s. In other regions of the Southwest, types analogous to Mancos Black-on-white are subdivided in many ways, including the following: Gallup, Escavada, Puerco, and Chaco black-on-white of the Cibola tradition; Chuska, Toadlena, and Burnham black-on-white of the Chuska tradition; Black Mesa, Sosi, and Dogoszhi black-on-white of the Kayenta tradition; and Kwahe'e black-on-white in the upper Rio Grande valley. In the Mesa Verde region, Hayes (1964*1:63-64) considered the carbon-painted variety of Mancos Black-on-white a separate type, which he called Wetherill Black-on-white. In the Crow Canyon system, such sherds are classified as either Mancos Black-on-white or McElmo Black-on-white and the paint type is recorded as carbon.

Paste: Medium to fine.

Temper: Usually crushed sherd, but crushed igneous rock, crushed sandstone, and sand were also used.

Surface Treatment: Variable. Painted surfaces are usually slipped and polished, but the quality of both is variable. The exterior surfaces of early Mancos Black-on-white bowls are often unslipped and unpolished, and they sometimes undulate, the result of the vessels having been cradled in the hands as their interior surfaces were scraped. Bowl exteriors can also be corrugated or basket-impressed. Surface treatment often appears cruder than that seen on Cortez Black-on-white, McElmo Black-on-white, Mesa Verde Black-on-white, and Pueblo III White Painted sherds.

Thickness: Variable. Usually thicker than Cortez Black-on-white but thinner than McElmo Black-on-white and Mesa Verde Black-on-white.

Painted Design:

Paint Type - Mineral paint is dominant in early Mancos Black-on-white sherds, but carbon (see Hayes's [1964*1:63-64] Wetherill Black-on-white) and mixed paint (a mineral paint suspended in an organic, pigmented binder) are more common on later examples.

Design - Design layouts take one of two forms: (1) wide "band" designs divided into panels by multiple, parallel lines oriented perpendicular to the rim, and with bold, solid geometric motifs inside each panel; and (2) "all-over," meander or fret designs made using broad solid lines or thin parallel lines with hachure filling. These fret patterns are similar to those seen in twill-plaited ring baskets. Other design motifs include checkerboards, dots, triangles, triangles with tick marks along sides that are oblique to the rim, and "drip lines." Bowl exteriors usually are not painted.

Rim: Usually tapered, but sometimes almost square. Often undecorated, but in the late examples may be painted with a solid line or simple, closely spaced tick marks.

Forms: A wide range, including bowls, jars, ollas, and ladles.

Pueblo II White Painted, TBW (A.D. 920–1180). Sherds are assigned to this type when they are too small, or the painted designs are too ambiguous, for the analyst to determine whether they are Cortez Black-on-white or Mancos Black-on-white. Because Cortez Black-on-white has such a distinctive appearance, it is usually possible to determine whether a sherd belongs to this type or not. Pueblo II sherds that are definitely not Cortez Black-on-white are classified as Mancos Black-on-white by default. As a result, few sherds are assigned to this grouped type.

Paste: Medium to fine.

Temper: Crushed igneous rock, crushed sandstone, crushed sherd and sand.

Surface Treatment: Variable. Ranges from well slipped and well polished to poorly slipped and poorly polished.

Thickness: Variable. Very thin to fairly thick, but not as thick as McElmo Black-on-white, Mesa Verde Black-on-white, or Pueblo III White Painted.

Painted Design:

Paint Type - Usually mineral (carbon-painted Pueblo II sherds are typically classified as Mancos Black-on-white).

Design - Most often, not enough design is present for the analyst to identify specific layouts and elements, but when discernible, design layouts and elements are consistent with those listed under the type descriptions for both Cortez Black-on-white and Mancos Black-on-white.

Rim: Usually tapered. May or may not be decorated; when decorated, usually painted with a solid line. Simple rim ticking is also found on some late examples that are transitional to McElmo Black-on-white.

Forms: A wide range, including bowls, jars, ollas, and ladles.

McElmo Black-on-white, EBW (A.D. 1060–1260). McElmo Black-on-white is one of the most difficult types to recognize in sherd collections (Figures 5.23–5.25). This is due to the significant design overlap with Mesa Verde Black-on-white and, to a lesser extent, with Mancos Black-on-white. Also, few “pure” McElmo Black-on-white assemblages have been reported in the literature. There is more agreement on the distinctions between McElmo Black-on-white and Mancos Black-on-white than on those between McElmo Black-on-white and Mesa Verde Black-on-white. Many researchers choose to not separate McElmo and Mesa Verde black-on-white as distinct types.

McElmo Black-on-white first appears at sites dating from around A.D. 1060, and it was quite common between A.D. 1100 and 1180. It continued to be made until the region was abandoned around A.D. 1280, but it was less common than Mesa Verde Black-on-white during the thirteenth century. McElmo Black-on-white is similar, but not identical, to Nava Black-on-white of the Chuska tradition and Chaco-McElmo Black-on-white of the Cibola tradition. Some styles of Flagstaff Black-on-white of the Kayenta tradition also bear a slight resemblance to McElmo Black-on-white.

Paste: Fine.

Temper: Usually crushed sherd, although some crushed igneous rock, crushed sandstone and sand were also used.

Surface Treatment: Decorated surfaces are often, but not always, well slipped but they are well polished, resulting in a finely finished surface. The exterior surfaces of bowls are usually slipped and polished, but they are not as finely finished as the interior surfaces.

Thickness: Thicker than the preceding types, but not as thick as late Mesa Verde Black-on-white.

Painted Design:

Paint Type – Both carbon and mineral paint were used. In general the frequency of mineral paint use declined over time, but the pace of this change varied from place to place (Wilson 1991*1: 29).

Design - Painted designs on McElmo Black-on-white vessels are transitional between those seen on Mancos Black-on-white and Mesa Verde Black-on-white vessels. Band designs predominate. Bowl exteriors are usually unpainted, but when they are decorated, the designs are simpler than those seen on the exterior surfaces of Mesa Verde Black-on-white bowls. In general, there are fewer design elements per piece, the designs themselves are simpler, and the design execution is a bit sloppier than what is seen in Mesa Verde Black-on-white. McElmo Black-on-white designs are made with lines of uniform width (as if they were executed using a single brush) on a true background, in contrast to designs on Mesa Verde Black-on-white vessels. The following design styles are diagnostic of McElmo:

1. Repeating, geometric band designs without framing lines (a framing line is a detached line that is oriented parallel to the rim and the main band of design, thus "framing" the design).
2. Band designs with one or more framing lines of equal thickness.
3. A band design consisting of framing lines of equal thickness, with or without tick marks in the spaces between the lines.

Other elements seen on McElmo Black-on-white sherds include triangles, checkerboards, stepped triangles, and solid stepped frets.

Rim: Fairly square, but not as square as the rims of Mesa Verde Black-on-white bowls. Occasionally rims are slightly tapered. If decorated, rims are painted with "ticks," not solid lines (Figure 5.24). Ticking is simple, not elaborate (cf. Mesa Verde Black-on-white type description).

Forms: Bowls, jars, ollas, ladles, and mugs are common.

Mesa Verde Black-on-white, VBW (A.D. 1180–1280). Recent research has documented sporadic occurrences of this type as early as A.D. 1100, but Mesa Verde Black-on-white first appears consistently in sites dating from about A.D. 1180. It became the dominant white ware type in the first decades of the thirteenth century and was still dominant when the Mesa Verde region was depopulated, around A.D. 1280 (Figures 5.26 and 5.27). Mesa Verde Black-on-white designs are similar, but not identical, to designs on other Pueblo III types in the northern Southwest, including Tusayan Black-on-white of the Kayenta tradition, Crumbled

House Black-on-white of the Chuska tradition, and Galisteo Black-on-white and Sante Fe Black-on-white of the Rio Grande tradition.

Paste: Fine.

Temper: Usually crushed sherd, although crushed rock and crushed sandstone were also used.

Surface Treatment: All visible vessel surfaces were well slipped and well polished. Surfaces may have even more of a pearly luster than the surfaces of McElmo Black-on-white vessels, and they often appear “crackled” because of the thickness of the slip

Thickness: In general, the thickest of all the listed types.

Painted Design:

Paint Type - Usually carbon, but some are mineral and some have both carbon and mineral paint. Mineral paint is common in sites along the Colorado-Utah border and near Aztec, New Mexico.

Design – The design layouts take one of three forms: flowing band designs, all-over designs, and designs composed entirely of framing elements. Bowls are sometimes decorated on their exterior surfaces, and when they are, the designs are more elaborate than the exterior designs seen on vessels of earlier types. In general, designs are more complex and vessel surfaces are more “filled in” with painted design than on McElmo Black-on-white vessels.

A. The following design characteristics are diagnostic of Mesa Verde Black-on-white flowing band designs:

1. Band designs are framed by multiple detached framing lines that must have been painted with brushes of varying widths. “Thick-and-thin” framing lines is one hallmark of Mesa Verde Black-on-white.
2. The solid motifs within the band interact via bifold rotation. That is the solid designs are repeated and rotated 180 degrees so that they nest against one another, see the designs on Figures 6.80 and 6.81.
3. The bands are either undivided or are divided into sections using oblique lines. As a result, the designs appear to “flow” continuously around the band.
4. Design in the band has an active background—that is, the white area has a distinct shape or design of its own.

5. Motifs commonly seen in Mesa Verde Black-on-white band designs include stepped triangles, “crow’s feet,” triangles with ticking along the sides that are vertical with respect to the rim, and solid-line frets that fill band sections.

B. The following design characteristics are diagnostic of Mesa Verde Black-on-white all-over designs:

1. On bowl interiors, use of hachure as a background filler around a solid, centered "medallion" design with radiating arms. The centered medallion may divide the vessel interior into halves, thirds, or quarters. There is usually a thin negative space of uniform width separating the solid design from the background hachure. Framing lines in such designs are usually limited to a single thick line at the rim.

2. Complex all-over designs in which typical Mesa Verde Black-on-white band designs are abstracted and used as panels that are oriented at angles to the rim instead of parallel to the rim.

C. Designs composed solely of complex framing elements include multiple-width framing lines and often patterned tick marks in the spaces between framing lines.

Rim: Bowl rims are square and usually decorated. Early Mesa Verde Black-on-white bowl rims are decorated with simple, repeating tick marks, but rim decorations become more elaborate through time and eventually include continuous zig-zags, X's, patterned ticking with gaps, and ticks of multiple sizes.

Forms: Many forms including: bowls, jars, kiva jars, mugs and ladles.

Pueblo III White Painted, HBW (A.D. 1100–1280). Pueblo III White Painted is another of the grouped types. This category is used to classify sherds that clearly are from vessels made during the Pueblo III period, but which are not clearly McElmo Black-on-white or Mesa Verde Black-on-white. Pueblo III White Painted is both a catch all for painted sherds that are small or have ambiguous characteristics *and* a category into which sherds possessing attributes intermediate between McElmo and Mesa Verde black-on-white are placed. In analysis systems that do not have grouped types, but instead recognize only traditional types, these sherds would be assigned to either McElmo Black-on-white or Mesa Verde Black-on-white.

Paste: Fine.

Temper: Usually crushed sherd, although some crushed rock, crushed sandstone and sand were also used.

Surface Treatment: All visible surfaces are well slipped and well polished, with a pearly luster.

Thickness: Relatively thick.

Painted Design:

Paint Type - Usually carbon paint, but some mineral and mixed carbon and mineral paints also occur.

Design - Any thick, painted sherd with fine paste, thick white slip, and a highly polished, lustrous surface—and on which the painted design is not clearly McElmo Black-on-white or Mesa Verde Black-on-white—is typed as Pueblo III White Painted. Specific design elements on Pueblo III White Painted sherds are similar to those listed above for McElmo Black-on-white and Mesa Verde Black-on-white.

Rim: Square or almost square. May or may not be decorated; if decorated, painted with simple tick marks.

Forms: Bowls, jars, kiva jars, and mugs are most common; other vessel forms are seen, but less often.

Late White Painted, LBW (A.D. 920–1280). The criteria for assigning sherds to the Late White Painted category are more general than those used to assign sherds to either the Pueblo II White Painted or the Pueblo III White Painted types. Late White Painted is used for sherds with attributes that are recognized as definitely **not** characteristics of pottery made during the Basketmaker III or Pueblo I periods; thus, these sherds are from vessels made during either the Pueblo II or Pueblo III periods. Late White Painted sherds do not meet the criteria for assignment to a more specific Pueblo II or Pueblo III category. Usually, the Late White Painted category is used for sherds that are too small, show too little painted design, or are too deteriorated to allow a more specific identification to be made. If paste, temper, and surface treatment indicate a post-A.D. 900 date of manufacture, but not enough of the painted design is left on the surface to allow the analyst to assess design layout or identify design elements, then the sherd is typed as Late White Painted.

For the most part, rim sherds are assigned to a more specific type than the Late White Painted; however, some small rims may be assigned to this category. Such rims are usually undecorated and relatively thin. Typically, so little of the painted design is present on sherds assigned to this type that design layout cannot be determined. If any of the design layouts described above for the traditional named types or for the Pueblo II or Pueblo III grouped types are present, the sherd would **not** be assigned to the Late White Painted category.

Late White Unpainted, LWU (A.D. 920–1280). Body sherds and rim sherds are assigned to this type derive from vessels that are interpreted to have been manufactured sometime after A.D. 900. Because these sherds do not have painted designs, classification is based solely on paste, temper, surface treatment, and thickness. Paste is medium to fine, and temper is usually crushed sherd, although crushed igneous rock, sand, and crushed sandstone are seen as well. Sherds assigned to this type are slipped and polished, but these surface treatments are of variable quality. Sherd thickness ranges from thin to thick.

Indeterminate Local White Painted, IBW (A.D. 575–1280). Sherds classified as Indeterminate Local White Painted are believed to have been manufactured locally, on the basis of their paste and temper but they are too small to be assigned to a more specific type.

Indeterminate Local White Unpainted, IND (A.D. 575–1280). Sherds are assigned to the Indeterminate Local White Unpainted category on the basis of the same criteria as are used for assigning sherds to the Indeterminate Local White Painted category; however, the former category is used for sherds with no painted decoration.

Local Red Ware Types

Red ware vessels were fired in an oxidizing atmosphere, which produced an orange to red surface finish. Red ware sherds may or may not be slipped but they are consistently polished. Red ware vessels generally have painted designs, but individual sherds may not.

Most red ware pottery excavated by Crow Canyon is of the San Juan tradition, it was manufactured in what today is southeastern Utah between A.D. 775 and at least A.D. 1050 (Wilson and Blinman 1995*1: 54) and is called San Juan Red Ware. These red ware sherds are treated as local types. San Juan Red Ware is most common in the western portion of the Mesa Verde region and becomes increasingly rare as one travels east. Thus, sherds of this ware account for as much as 25 percent of assemblages from Alkali Ridge in Utah, 8 to 10 percent of assemblages in the Dolores River area (Colorado), and only a small percentage of assemblages in the Animas River drainage, near Durango, Colorado (Wilson and Blinman 1995*1: 53-54). After A.D. 1050, red ware production shifted to northeastern Arizona (Tsegi Orange Ware of the Kayenta tradition) and west-central New Mexico and east-central Arizona (White Mountain Red Ware). Both Tsegi Orange Ware and White Mountain Red Ware are treated as nonlocal pottery in the Crow Canyon analysis system (refer to Nonlocal Pottery section, pages 5-20–5-21).

Sherds of the different red wares are distinguished primarily on the basis of paste and temper characteristics. San Juan Red Ware pottery was fired in a poorly controlled atmosphere, and as a result, paste colors grade from red to orange to gray on a single vessel. The paste is usually fine and tempered with igneous rock. Only San Juan Red Ware sherds are analyzed to traditional type in Crow Canyon's basic pottery analysis. Red ware sherds of other traditions are classified as one of two general "grouped" types, Other Red Nonlocal or Unknown Red. When it is possible

to identify such sherds to a traditional nonlocal ware and type, this information is recorded on the comments line of the analysis label.

Abajo Red-on-orange, ARO (A.D. 725–880). Abajo Red-on-orange first appears in sites dating from approximately A.D. 725. It was the only red ware type at sites in the Mesa Verde region until about A.D. 800, after which it was gradually replaced by Bluff Black-on-red. Abajo Red-on-orange disappears from assemblages by about A.D. 880.

Abajo Red-on-orange is recognized primarily on the basis of paint and background sherd color (Figure 5.28). Abajo Red-on-orange is characterized by an orange background with orange- to red-painted designs and crushed-rock temper. The orange surface is the result of the pottery having been oxidized during firing. The core is usually gray. The sherds are highly polished, and the paint is polished as well. Sherds of this type are usually unslipped.

Designs on Abajo Red-on-orange vessels are relatively simple and bold, and they often appear to have been painted with the fingers rather than with a brush. Design elements include straight lines, wavy lines, triangles, and ticked lines. Design layout may be bilateral, spiral, all-over, or, more rarely, band. The predominant vessel form is the bowl, but occasionally other vessel forms are found.

Bluff Black-on-red, BRE (A.D. 800–1020). This type began to succeed Abajo Red-on-orange in the early 800s, and the transition was complete by about A.D. 840. Sherds of this type are present in contexts dating from as late as A.D. 920, and the type may have persisted through the early eleventh century.

As with Abajo Red-on-orange, it is the paint and background color, more than the design elements and layout, that are used to identify sherds as Bluff Black-on-red (Figure 5.29). A sherd with crushed-rock temper and black paint on an orange to light red background is classified as Bluff Black-on-red. These sherds are usually not slipped, but occasionally a thin, washy slip is present. Paint sometimes consists of specular hematite, and it may be polished. Paste characteristics are identical to those described for Abajo Red-on-orange.

Design elements on early Bluff Black-on-red vessels are identical to those on Abajo Red-on-orange vessels. Through time, there is a trend toward increasingly fine linework and design elements, a distinct change from the straight and wavy lines evident in the earlier Bluff pottery. Designs on late examples overlap with Deadmans Black-on-red designs.

Deadmans Black-on-red, DRE (A.D. 880–1100). This type began to replace Bluff Black-on-red in the late ninth century, and persisted until A.D. 1100. This date of onset is significantly later than previously reported (Breternitz et al. 1974*1) because analysts today identify some slipped sherds with black-painted designs as Bluff Black-on-red, whereas earlier analysts classified all slipped San Juan Red Ware sherds as Deadmans Black-on-red. Designs on Deadmans Black-on-red vessels are similar to those on Tusayan Black-on-red and Middleton Black-on-red vessels (both Tsegi Orange Ware), reflecting a single northern red ware style

during the period of overlap between the two traditions (Wilson and Blinman 1995*1: 57). Distinguishing Deadmans Black-on-red sherds from Tusayan Black-on-red sherds requires a careful examination of temper. Deadmans Black-on-red has at least some crushed igneous rock, whereas Tusayan Black-on-red has sherd and sand tempers only.

Deadmans Black-on-red vessels usually have a deep red slip (Figure 5.30) that is distinct from the surface color of a Bluff Black-on-red vessel. Deadmans Black-on-red designs are also distinctive among red ware types, and are similar to those of Cortez Black-on-white. Design elements include the use of bands filled with diagonal and squiggle hachure and the use of thin, straight nested lines with attached triangles. The hachure design elements are often part of an all-over design layout (Dogoszhi-style).

Indeterminate Local Red Painted, RED (A.D. 725–1100). Red ware sherds tempered with at least some crushed igneous rock are assigned to this category when (1) the paint color is ambiguous (neither red nor black—frequently the result of misfiring), or (2) a black-painted sherd is too small for the analyst to determine the design configuration and/or the presence/absence of slip.

Indeterminate Local Red Unpainted, INR (A.D. 725–1100). Any unpainted red ware sherd tempered with at least some crushed igneous rock is assigned to this type.

Nonlocal Pottery

Nonlocal sherds are assigned to one of several very general nonlocal grouped types during preliminary sherd analysis: Other Gray Nonlocal (OGR), Other White Nonlocal (OBW), Other Red Nonlocal (ORE), and Polychrome (PLY). When it is possible for the analyst to determine a specific nonlocal ware, that information is recorded on the comments line of the analysis label. Listed below are criteria for the identification of nonlocal sherds to more-specific ware categories (after Wilson and Blinman 1988*1); these are the names that should be recorded on the comments line.

Chuska White Ware and Gray Ware. Chuska wares are characterized by the presence of a distinctive crushed trachybasalt (trachyte, sanadine basalt) temper that sparkles on the surface of the sherd even without magnification. Biotite mica is also present with some frequency. Pastes are generally blue-gray in color. When present, slip will be thin, and paint can be organic or mineral. The fine-line hachure of Gallup Black-on-white (Chuska White Ware) is distinctive (Figure 5.31) when compared to the thicker-lined, less careful hachure on Mesa Verde types.

Cibola White Ware and Gray Ware. Cibola wares are characterized by sand or crushed-sandstone temper. Because of this, Cibola Gray Ware is often indistinguishable from Tusayan Gray Ware, which has quartz sand temper. However, one of the crushed-sandstone

temper used in Cibola Gray Ware has a distinctive pink chalcedonic cement that does not occur in other gray wares. It should also be noted that crushed conglomerate sandstone was used as temper in locally made vessels in parts of the Mesa Verde region (Wilson 1991*1).

Cibola white ware has a brown to red mineral paint, and a thin, washy slip that is not highly polished. “Slip-slop” (slip that was applied only around the rim area) can occur on the exterior surfaces of bowls, but otherwise bowl exteriors are usually unslipped and unpolished. The fine-line hachure of Chaco Black-on-white (Cibola White Ware) is also distinctive (Figure 5.31) when compared to the hachure of the Mesa Verde types which tends to be made of thicker lines that are less carefully applied.

White Mountain Red Ware. This very distinctive red ware, which derives from the Puerco River region of west-central New Mexico and east-central Arizona, has a buff to red body clay that is tempered with large pieces of crushed sherd. Sherds have a thick, bright red slip, and the paint can be organic or mineral. Polychromes are common, especially with white and red on bowl exteriors, and black and red on bowl interiors (Figure 5.32).

Tusayan White Ware and Gray Ware. These wares originate in northeastern Arizona and are identified by their quartz sand temper—there is no igneous rock temper. As noted above, Tusayan Gray Ware are only distinguishable from Cibola Gray Ware at the microscopic level by identifying the temper. On Tusayan White Ware vessels, pastes are white to blue in color, surfaces were polished to a pearly white but were rarely slipped. Rim ticking on bowls is rare. The designs on white ware vessels are distinctive (see Beals, et al. 1945*1) and were executed in organic paints in all time periods.

Tsegi Orange Ware. This ware, which derives from northeastern Arizona, is characterized by crushed-sherd temper; no igneous rock temper is used. Surfaces were decorated with mineral and clay paints and slip is rare (hence the orange ware label instead of red ware). Designs are distinctive, and include polychrome designs that do incorporate slips (Figure 5.33).

Unknown Pottery

In some cases it is impossible to determine whether small or heavily eroded sherds were made locally or not. Such sherds are assigned to one of the general categories: Unknown Gray (UNG), Unknown White (UNW), Unknown Red (UNR), and Unknown Pottery (UNP).



Figure 5.1. Chapin Gray rim sherds.



Figure 5.2. Moccasin Gray (neckbanded) body sherd.



Figure 5.3. Mancos Gray (neckbanded) body sherds.



Figure 5.4. A comparison of Mancos Gray (top) and Moccasin Gray (bottom) sherds, showing variation in coil flatness.



Figure 5.5. Indeterminate Local Gray body sherds.



Figure 5.6. Mancos Corrugated Gray rim sherd.



Figure 5.7. Side view of a Mancos Corrugated Gray rim sherd.



Figure 5.8. Mancos Corrugated Gray jar with incised pattern on exterior.



Figure 5.9. Mesa Verde Corrugated Gray rim sherds.



Figure 5.10. Side view of a Mesa Verde Corrugated Gray rim sherd.



Figure 5.11. Mesa Verde Corrugated Gray jar.



Figure 5.12. Mummy Lake Gray rim sherds.

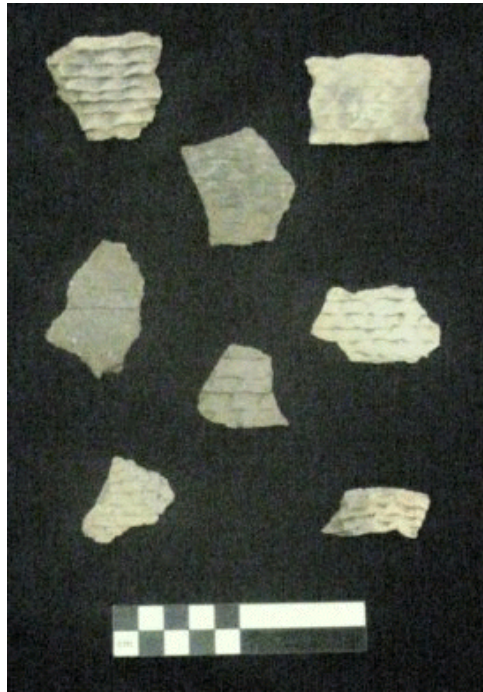

Figure 5.13. Indeterminate Local Corrugated Gray body sherds.



Figure 5.14. Chapin Black-on-white sherds.



Figure 5.15. Chapin Black-on-white bowl fragment.



Figure 5.16. Piedra Black-on-white sherds.



Figure 5.17. Piedra Black-on-white bowl fragment.



Figure 5.18. Cortez Black-on-white sherds.



Figure 5.19. Cortez Black-on-white bowl fragment.



Figure 5.20. Mancos Black-on-white sherds.



Figure 5.21. Mancos Black-on-white bowl.



Figure 5.22. Side view of a Mancos Black-on-white bowl. Note the U-shaped profile of the vessel and corrugated exterior.



Figure 5.23. McElmo Black-on-white sherds.



Figure 5.24. McElmo Black-on-white bowl.



Figure 5.25. Side view of a McElmo Black-on-white bowl. Note the hemispherical profile of the vessel.



Figure 5.26. Mesa Verde Black-on-white sherds.



Figure 5.27. Mesa Verde Black-on-white bowl fragment.



Figure 5.28. Abajo Red-on-orange sherds.



Figure 5.29. Bluff Black-on-red sherds.



Figure 5.30. Deadmans Black-on-red sherd.



Figure 5.31. Gallup Black-on-white (top row) and Chaco Black-on-white (bottom row) sherds.



Figure 5.32. White Mountain Red Ware sherds.



Figure 5.33. Examples of Tsegi Orange Ware sherds.

Chapter 6

Basic Pottery Analysis

The ancestral Pueblo people manufactured pottery vessels in their own communities, and they imported pottery from other communities and regions. Over time and across space, pottery changed in many of its features, including the raw materials from which it was made, the shapes of vessels, and the styles of painted designs. This, coupled with the fact that fired clay is quite durable, makes pottery an extremely valuable source of information for archaeologists. Pottery is an important tool in the dating of ancient Pueblo sites, and it can provide insights into a wide variety of other topics of interest to researchers—for example, population size, length of site occupation, patterns of trade, the evolution of technological skill, and the kinds of activities that took place in specific locations within sites.

Given the wealth of information that pottery analysis can yield, it is not surprising that Crow Canyon puts strong emphasis on this component of our laboratory process. Basic pottery analysis follows cataloging (see the flowchart in Chapter 2) and is performed by staff, interns, volunteers, high school students, and adult participants in our programs. Because we strive for highly reliable data, we continuously reassess our analysis methods. The procedures presented in this chapter reflect our current methods of pottery analysis which we believe produce highly accurate, comprehensive, and reliable results.

The remainder of this chapter is divided into six parts. “Using this Guide” and “Getting Started” contain introductory material designed to orient you before you begin actual analysis. The next three sections, which make up the main body of the chapter, focus on the analysis methods used by Crow Canyon: “Corrugated and Neckbanded Pottery” on page 6-4; “‘Other’ Pottery” begins on page 6-13 and includes a discussion of plain gray ware, unpainted white ware, red ware, and nonlocal pottery; “Painted Pottery” begins on page 6-25 and covers locally produced painted pottery. The final section, “Pottery Universals,” starts on page 6-41. It is a reference section that provides details about specific pottery attributes or about analysis procedures that are repeated numerous times during analysis. Rather than repeat this information many times, we provide it just once at the end of the chapter.

Using this Guide

The following pages walk you through Crow Canyon's pottery analysis procedures, step-by-step. Everything you need to know to perform these procedures is contained in these pages.

In our analysis system we identify the ware, part, form, finish, and type of each sherd, and we count and weigh all sherds either individually or in groups, depending on the situation. **REMEMBER:** Most bags of pottery will not contain every type of sherd discussed in this guide. If you do not have any sherds of the type discussed in a particular step, you should move on to the next step.

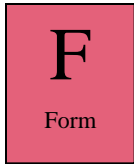

Red boxes like the one to the left indicate that there is additional information in "Pottery Universals" that may help you perform a step correctly. These boxes can also prompt an action on your part. For example, the capital letter "F" and the word "Form" in the box to the left indicates that you should sort sherds according to vessel form as part of any step for which this box is displayed. If you can't remember all the possible vessel forms or how to identify them, you should turn to the Form page of the universal section to get this information.

The following topics are considered in "Pottery Universals" (the code for each is shown in bold):

Bag, **C**omments, **C**ount and **W**eight, **F**orm, **F**inish, **I**tem Number, **A**nalysis **L**abel, **P**art, **S**lip and **P**olish, **T**emper and **P**aste.

These topics are arranged alphabetically by the code letters. You may find it helpful to peruse the universal section before beginning pottery analysis.

Getting Started

Inside the bag of “bulk sherds, large” you will find a field specimen (FS) label that provides the provenience information for the items in this bag (Figure 6.1). The label should be mostly filled out. A blank label is illustrated in Figure 6.2. **DO NOT CONTINUE IF YOU CANNOT FIND THIS LABEL, FIND A STAFF PERSON AND NOTIFY THEM OF THE PROBLEM!**



Figure 6.1. Contents of bulk sherds, large bag with provenience label.

Nested inside the bag will be some or all of the following:

- **A bag of corrugated and/or neckbanded gray ware pottery.** The sherds in this bag should have exposed, unobliterated coils on their exterior surfaces. They do not have slip, polish or paint. We will analyze the contents of this bag first (Chapter 6: Section A).
- **A bag of painted white ware pottery.** These sherds should be white ware sherds with paint on one or both surfaces. The contents of this bag will be analyzed last (Chapter 6: Section C).
- **A bag of “other” pottery.** This bag contains the sherds that do not belong in the other two bags. The contents of this bag will be analyzed second (Chapter 6: Section B).

SITE: 5MT123	DE date _____	Analyst _____ Date _____
PD _____	FS _____ PL _____	
STUDY UNIT _____		
HOR. _____	VERT. _____	
FEATURE _____		
HOR. _____	VERT. _____	
BAG DATE _____	FIELD SUP _____	
CONTENTS _____		
Count _____	Weight _____	

Figure 6.2. Provenience label.

Before you begin, make sure the provenience label has been filled out correctly. If information is missing from the label or if there are other problems ask a staff person to check the label.

Section A: Corrugated and Neckbanded Gray Ware Pottery

Step 1: Empty the Contents of the Bag

Step 2: Separate Corrugated Gray Ware Sherds from the rest of the sherds

Corrugated gray ware sherds have patterned indentations on their exterior surfaces (Figure 6.3),. The result of a finger, thumb, or tool having been pressed at uniform intervals into the clay coils as the vessel was formed. On the interior surface, the coils were scraped smooth (Figure 6.4). Corrugated gray ware pottery has no slip, polish, or paint. The temper particles are visible to the naked eye on both surfaces and in the broken cross section of the sherd.

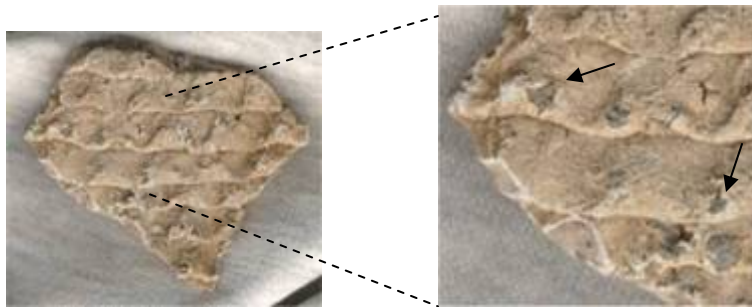

Figure 6.3. The exterior surface of a corrugated gray ware sherd showing finger indentations and temper (see the arrows in the photo on the right)



Figure 6.4. The scraped interior surface of a corrugated gray ware sherd.

SP
Slip and
Polish

Fn
Finish

TP
Temper and
Paste

Important: There may be sherds in this bag that are not corrugated gray ware. These include neckbanded sherds, basket-impressed sherds, and sherds from white ware jars or bowls that also have corrugations. See the following two pages for more information on these special cases.

Step 3: Checking for Unusual Pottery in the Corrugated Gray Ware Bag (page 1 of 2)

Some sherds in the bag of corrugated pottery may actually belong in other pottery categories. Because such sherds are rare or they look similar to corrugated pottery, they may be placed in the bag of corrugated pottery during cataloging. Some of these cases will be analyzed during this step, but others should be moved to “painted” or “other” bags for analysis at the appropriate time. Study these special cases, and then check each sherd to make sure it truly belongs in your pile of corrugated gray ware sherds.

Corrugated White Ware: Some sherds with corrugation are from vessels identified as white ware on the basis of the presence of slip, polish, and/or paint on one or more surfaces (Figure 6.5). If the sherd is painted, it should be placed in the “painted” bag. If it is slipped and/or polished, but not painted, it should be placed in the “other” bag. Corrugated white ware sherds most often are from jar necks and bowl exteriors.



Figure 6.5. Corrugated white ware sherds that are painted are analyzed with the painted pottery. Corrugated white ware sherds that are slipped and/or polished, but not painted are analyzed with the “other” pottery.

Jar Necks: Sherds from the necks of large white ware jars occasionally are corrugated on their exterior surfaces (Figure 6.6); slip was often applied over the corrugations. Place such sherds in the “other” pottery bag.



Figure 6.6. White ware jar with a corrugated neck.

Bowl Exteriors: The vast majority of sherds with corrugation are from jars. However, corrugations are occasionally seen on the exterior surfaces of white ware bowls (Figure 6.7). If you find such a sherd and it is painted, place it in the “painted” bag. If it is slipped and/or polished, but not painted, place it in the “other” bag.



Figure 6.7. The top view shows the exterior surface of a corrugated white ware bowl sherd; the bottom view shows the interior surface of the same sherd.

More special cases on the next page . . .



TP
Temper and
Paste

SP
Slip and
Polish

Step 3: Checking for Unusual Pottery in the Corrugated Gary Ware Bag (page 2 of 2)

Basket-Impressed: These are sherds from bowls that were molded into a basket (Figure 6.8). Impressions will be visible on the exterior surface. If you find such a sherd and it is painted, place it in the “painted” pottery bag; if it is slipped and/or polished, but not painted, place it in the “other” pottery bag.



Figure 6.8. A basket-impressed sherd; detail. The basket that made this particular impression was made by coiling.

Neckbanded: Neckbanded gray ware sherds are from jars that had exposed coils on the exterior surfaces of their necks (Figure 6.9). These coils are not corrugated, they can vary from wide and flat to narrow and round. Any neckbanded sherds should be set aside and analyzed in Step 8, this section.



Figure 6.9. Neckbanded gray ware jar.

Note: Each basket-impressed sherd will be given an **item number**, regardless of whether it is a rim sherd or a body sherd.

C
Comments

TP
Temper and
Paste

SP
Slip and
Polish

Step 4: Sort the Corrugated Gray Ware Sherds by Part: Body Sherds, Rim Sherds, and Base Sherds

Body sherds

Body sherds come from the medial portion of the vessel and exclude the rim and the base (Figure 6.10). Body sherds are broken on all edges (Figure 6.11). As you sort body sherds, place them in piles of 10 for easier counting.



Figure 6.11. Corrugated body sherds.



Figure 6.10. Corrugated jar. Shaded areas indicate body and rim sherds.

Rim sherds

Rim sherds have a finished edge that was part of the rim of the jar (Figures 6.10 and 6.12). On many corrugated gray ware jars, the clay was smoothed in a band around the rim, forming a fillet. It is common for a vessel to break at the juncture of the rim fillet and the first circuit of corrugation. The resulting piece has an undulating edge at the break. Set the rim sherds aside.



Figure 6.12. Corrugated rim sherd.

Base Sherds

Sherds from the bases of corrugated jars show the coils starting at a center point and spiraling outward (Figure 6.13). Set these sherds aside.



Figure 6.13. Sherd from the base of a corrugated jar.

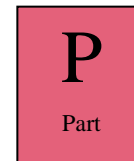

Step 5: Record and Bag the Corrugated Gray Ware Body Sherds

Corrugated gray ware body sherds are typed as **Indeterminate Local Corrugated Gray** (CRG). Fill out the pottery analysis label according to the instructions in the blue box. Place the corrugated body sherds and the pottery analysis label in a bag. Crow Canyon no longer uses a pottery analysis form, all of the data is recorded on the analysis label and is entered into the database directly from the analysis labels.

On the analysis label, the light blue boxes indicate areas where information specific to your bag of pottery should be recorded. The first thing to do is fill in the PD and FS numbers. Next, fill in the type name. The type name may be abbreviated as *Ind. Corrugated*. The type code is "CRG." The form is "jar." The part is "body." Determine count and weight, and record them in appropriate spaces. Finish, vessel #, and item are not applicable to this group of sherds. Use the Comment line to record anything noteworthy or unusual about any of the sherds in this bag. YOU SHOULD ALWAYS PUT A DASH IN ANY SPACE FOR WHICH INFORMATION IS NOT APPLICABLE. This tells a reader that you have filled out the label completely.

SITE: 5MT123
PD FS Item
Type name Ind. Corrugated
Type code CRG
Form jar Part body
Finish --- Vessel # ---
Count Weight
Comments _____

CW
Count and
Weight

B
Bag

L
Label

Step 6: Identify, Record and Bag *Mancos Corrugated Gray*, *Mesa Verde Corrugated Gray*, and *Indeterminate Corrugated Gray* Rim Sherds by Type:

Corrugated rims are identified as one of three types on the basis of the degree of rim eversion. Rim eversion refers to the degree to which the rim flared outward from vertical on the parent vessel. If the rim eversion is less than 30 degrees, the sherd is classified as **Mancos Corrugated Gray** (MRG) (Figure 6.14). If the rim eversion is 30 degrees or more, the sherd is classified as **Mesa Verde Corrugated Gray** (VRG) (Figure 6.15).

Mancos Corrugated Gray (MRG)

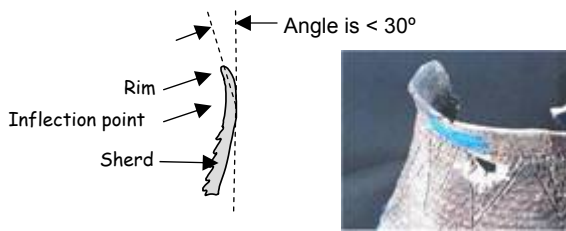

Figure 6.14. View of a *Mancos Corrugated Gray* jar showing the less-everted rim.

Mesa Verde Corrugated Gray (VRG)

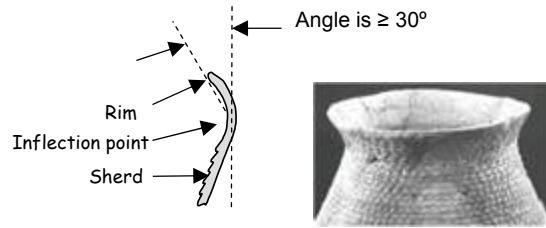

Figure 6.15. View of a *Mesa Verde Corrugated Gray* jar, showing the more-everted rim. **Photo by David M. Grimes.**

Indeterminate Local Corrugated Gray (CRG)

Rims that are too small or too irregular for the degree of eversion to be determined are classified as Indeterminate Local Corrugated Gray.

A label can now be filled out for each corrugated rim, remember each gets an item number.

Tips for determining rim eversion:

Pick three points along the rim, and orient them on a level plane.

Look at the curvature around the jar (at the inflection point). It should parallel the rim (Figures 6.14 and 6.15).

Look for scrape marks on the interior surface of the sherd—these should also parallel the rim.

Now, while holding the rim sherd in its correct position in relation to the whole vessel, try to determine the degree of eversion.

Important: Each rim sherd is assigned an **item number**. Item numbers are assigned sequentially, beginning with 1 and continuing until all sherds from a bag of pottery assigned a given FS number have been analyzed. Sherds from the bases of corrugated jars also receive item numbers (see Step 7, this section). Each sherd assigned an item number gets a label and is bagged individually.

SITE: 5MT123
 PD FS Item
 Type name
 Type code
 Form Jar Part Rim
 Finish Vessel #
 Count 1 Weight
 Comments

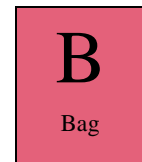
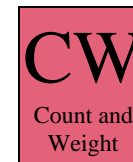

Step 7: Identify, Record and Bag Sherds from the Bases of Corrugated Gray Ware Jars

Each sherd from the exterior base of a corrugated jar is also given an **item number**. These sherds can be identified by the coils starting at a center point and spiraling outward (Figure 6.16). NOTE: There is no part code for base. Such sherds are recorded as body sherds and are bagged individually; a comment is written to identify each as being from the base of a corrugated jar. Also, if the direction of the coiling can be determined (see Figure 6.16 caption) it should be written in the comment field.



Figure 6.16. This photo shows a sherd from the base of a corrugated jar, where the potter initiated the coiling pattern. Note that the coiling spirals clockwise on this sherd.

On the **analysis label**, record type name as *Ind. Corrugated*. The type code is "CRG." The form is "jar." The part is "body." Determine count and weight and record them in the appropriate spaces. Finish, vessel #, and Item are not applicable to this group of sherds, so put a dash in these spaces.

SITE: 5MT123
 PD FS Item
 Type name Ind. Corrugated
 Type code CRG
 Form jar Part body
 Finish --- Vessel # ---
 Count 1 Weight
 Comments Corrugated base, clockwise.

CW
 Count and Weight

C
 Comments

B
 Bag

Step 8: Identify the Neckbanded Gray Ware Sherds by Type: Mancos Gray and Moccasin Gray

As the name suggests, neckbanded jars are distinguished by the presence of distinctive bands on the exterior surfaces of their necks. The bands are the unscraped coils used to build the vessel; unlike the unscraped coils of corrugated vessels, those on neckbanded jars were not textured with indentations (corrugations). The coils of neckbanded jars were usually scraped smooth below the vessel shoulder, so sherds that derive wholly from the lower portions of these containers are not recognized or classified as neckbanded (Figures 6.17 and 6.18). The temper of neckbanded sherds is usually coarse and visible on both interior and exterior surfaces. Be aware that on some corrugated gray vessels, potters created overall surface patterns by corrugating some coils and leaving others smooth. If you find a sherd with both smooth and corrugated coils, classify it as corrugated, not as neckbanded.

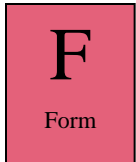
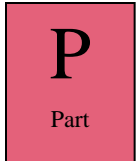

Two types of neckbanded pottery can be differentiated on the basis of the size and shape of the bands and the degree to which they overlap.

Moccasin Gray (MGR) is distinguished by relatively wide, flat coils that are stacked “edge to edge” on top of one another and therefore do not overlap (Figures 6.17, 6.19 and 6.20). On occasion, crude scraping during manufacture resulted in the partial obliteration of the coil junctures.



Figure 6.19. *Moccasin Gray* neck sherd with wide, flat, stacked coils.



Figure 6.20. Cross section of *Moccasin Gray* sherd showing stacked coils.

Mancos Gray (AGR) is distinguished by narrow, rounded coils or by wider, overlapping coils on the neck of a vessel (Figures 6.18, 6.21 and 6.22).

Sherds from below the shoulder are not classified as neckbanded gray ware.

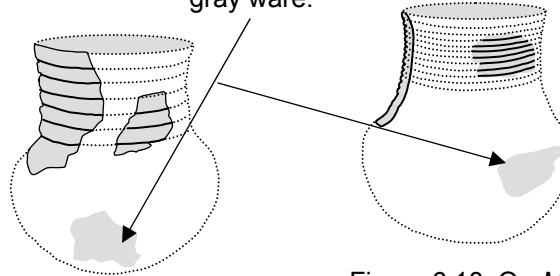

Figure 6.17. On *Moccasin Gray* sherds the coils are wide, flat, and “stacked” one on top of another.

Figure 6.18. On *Mancos Gray* sherds the coils are

- small and round, or
- wide and flat, with each coil overlapping the coil below it.



Figure 6.21. Rim sherds from a *Mancos Gray* jar.



Figure 6.22. Cross section of *Mancos Gray* sherd showing wide, overlapping coils.

See the next page to learn about *Indeterminate Neckbanded Gray* and how to fill out the analysis label.

Step 9: Identify Indeterminate Neckbanded Gray Ware Sherds

Sherds that cannot be clearly identified as either **Mancos Gray (AGR)** or **Moccasin Gray (MGR)** are classified as **Indeterminate Neckbanded Gray (ING)** are classified as **Indeterminate Neckbanded Gray (ING)**. Neckbanded coils are considered to be indeterminate if you cannot determine whether they are wide and flat or narrow and rounded.

Step10: Record and Bag Neckbanded Gray Ware Sherds

Neckbanded body sherds of the same type and form are bagged and labeled together. Be sure to record the count and weight on the analysis label.

Each neckbanded rim sherd is given an item number and then is labeled and bagged individually. Continue assigning item numbers where you left off with the corrugated rims and bases.

Important: Handle sherds are also given item numbers. Occasionally neckbanded sherds have handles or handle attachments. Such sherds are also given item numbers, even if no part of the rim is present. If the rim is present, the sherd is identified as a rim sherd, but a comment should be included stating that the sherd also has a handle or part of a handle.

F Form	P Part	L Label
I Item Number	CW Count and Weight	B Bag

Record *Moccasin Gray (MGR)*, *Mancos Gray (AGR)*, or *Indeterminate Neckbanded Gray (ING)* on the type name and type code lines of the analysis label. Record form which, for all of these sherds will be "jar" and part which could be rim or body. Finish and vessel # are not applicable, so draw lines through these spaces. Be sure to record count and weight.

SITE: 5MT123

PD FS Item

Type name

Type code

Form Part

Finish Vessel #

Count Weight

Comments

Section B: “Other” Pottery

“Other” pottery includes all sherds that do not belong in the “painted white ware” or “corrugated and neckbanded gray ware” categories.

Step 1: Identify the Contents of the Other Pottery Bag

Find the bag of “other” pottery and pour out its contents. Make sure there are no corrugated, gray, neckbanded gray or painted white ware sherds in the bag. If any are found, integrate them with the appropriate bags. Sort the remaining sherds into the following five groups:



Figure 6.23. Plain Gray ware sherd.

Plain Gray Ware: sherds have surfaces that were scraped (that is, the coil junctions were obliterated), but were neither polished nor slipped (Figure 6.23). The temper is visible to the naked eye, and the paste is coarse, similar to the temper and paste of corrugated gray pottery.



Figure 6.24. Unpainted white ware sherd.

Unpainted White Ware: sherds are slipped and/or polished, but not painted (Figure 6.24). These sherds often are from undecorated portions of painted vessels. White ware pottery usually has finer paste than gray ware pottery, and the temper is often difficult to see with the naked eye.

Local Red Ware: sherds have reddish surfaces because their parent vessels were fired in an oxidizing atmosphere. They are usually polished, and they may or may not be slipped and/or painted (Figure 6.25). Local red ware vessels usually have a fine paste, a gray core in cross section, and finely crushed rock temper.



Figure 6.25. Local red ware sherd.

Nonlocal sherds were made by people who were not part of the Mesa Verde cultural tradition (Figure 6.26). Nonlocal sherds are identified on the basis of paste, temper, and/or painted design. You should seek the assistance of a staff member if you think you have any nonlocal pottery.



Figure 6.26. Nonlocal sherds (White Mountain Red Ware).

“Unknown” sherds are those that do not appear to fit into any other categories (Figure 6.27).



Figure 6.27. “Unknown” sherd.

Remember: You can skip each step for which you do not have any examples in your bag.

Step 2: Identify, Record and Bag the Plain Gray Ware Sherds by Part

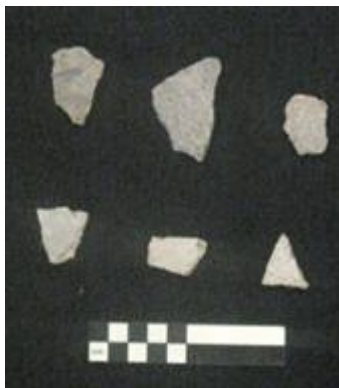

Figure 6.28. *Indeterminate Local Gray* body sherds.



Figure 6.29. *Chapin Gray* body sherd with fugitive red pigment.

Once you have identified the plain gray sherds, sort them by vessel part, rim or body sherds. All plain gray body sherds, that is sherds that are from below the rim of the vessel, are classified as *Indeterminate Local Gray* (GRA) (Figure 6.28) and are considered to be from jars. The body sherds can now be recorded, counted, weighed, and they can be bagged as a group with the analysis label.

See the next page for information about plain gray rims and handles.

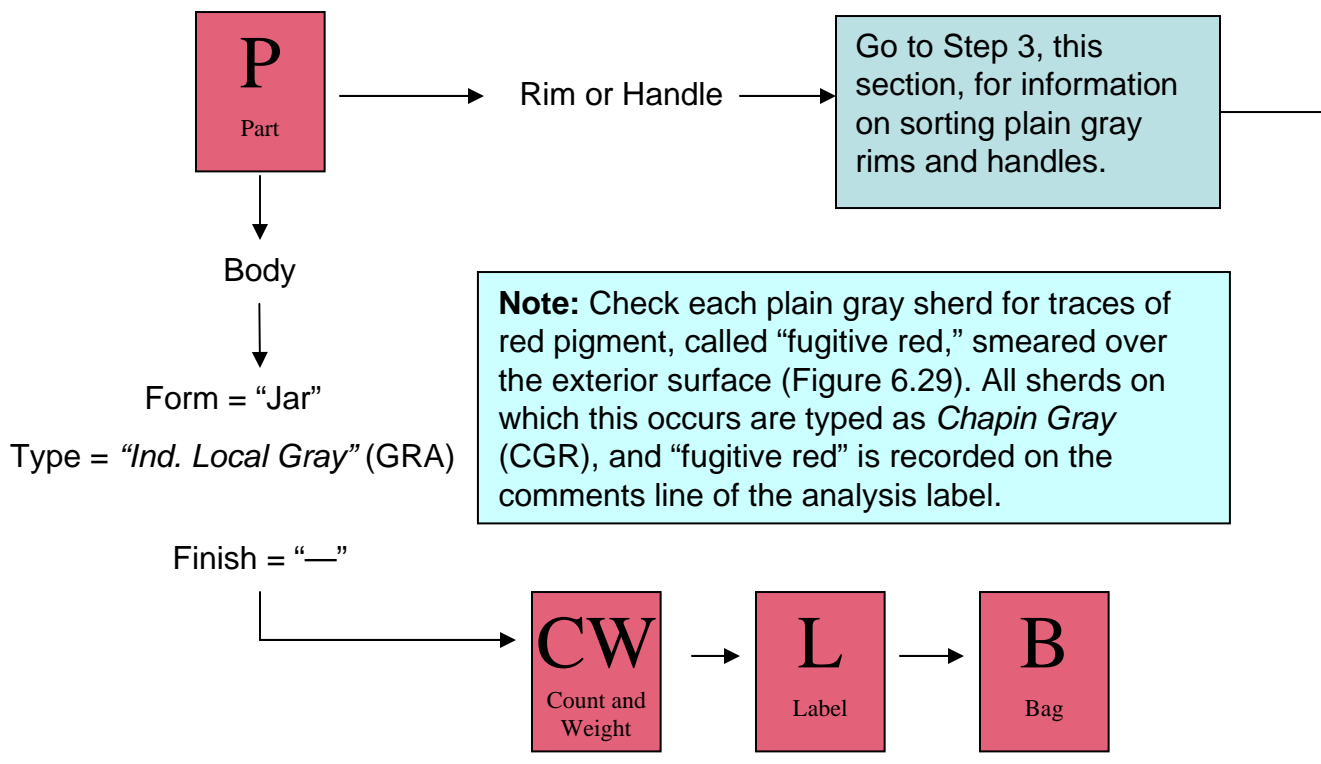
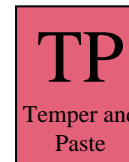

Step 3: Identify, Record and Bag the Plain Gray Rim and Handle Sherds

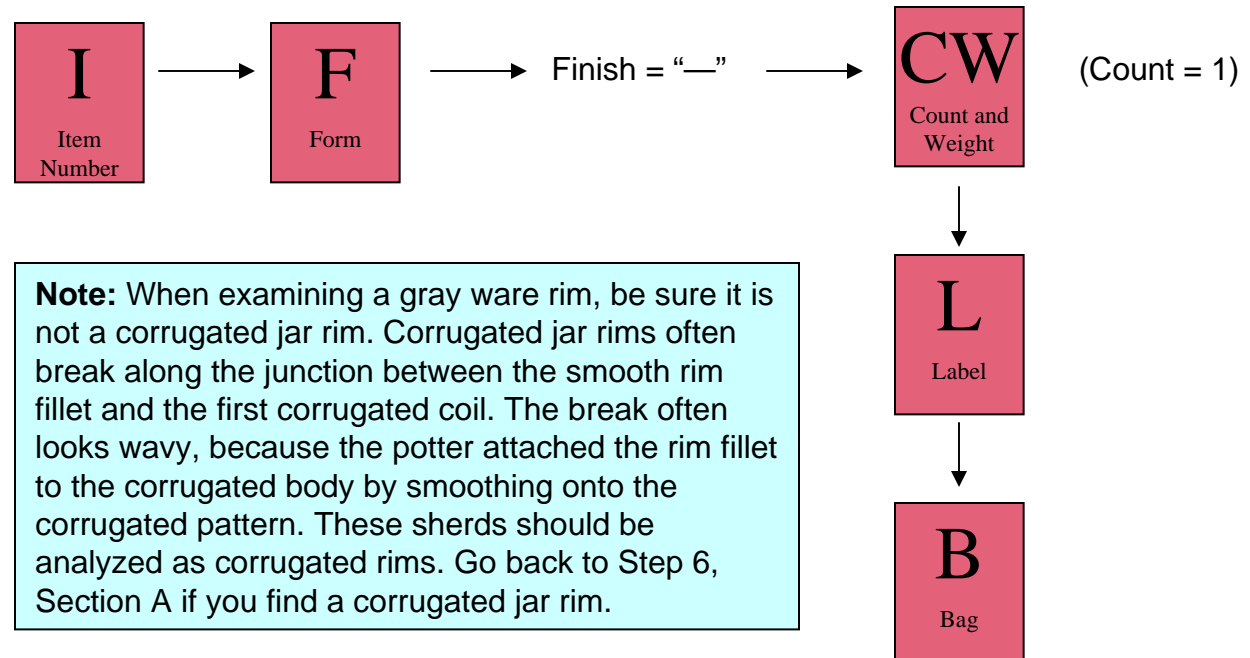

Figure 6.30. *Chapin Gray* rim sherd.

Plain gray rim sherds are typed as *Chapin Gray* (CGR) (Figures 6.30 and 6.31). *Chapin Gray* rims have no visible bands or coils. In contrast, neckbanded vessels have coil junctures that are visible on the exterior of the neck (Figure 6.31). Plain gray handle sherds are typed as *Indeterminate Local Gray* (GRA). Plain gray rims and handles come from a variety of vessel forms. Consult the Form page in “Pottery Universals” for help in identifying these. Once you have identified the pottery type and vessel form of each rim and handle, you will need to fill out an analysis label. Remember that each rim and handle gets an analysis label and an item number.



Figure 6.31. Neckbanded sherd.



Step 4: Identify the Unpainted White Ware Sherds by Type: *Early White Unpainted*, *Late White Unpainted*, and *Indeterminate Local White Unpainted*

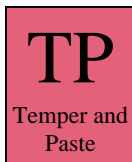

Although they are sometimes difficult to identify, unpainted white ware sherds are distinguishable from plain gray sherds by their paste, temper, and surface treatment. Unpainted white ware sherds usually have fine paste and the temper is usually made up of either finely crushed-sherd or finely crushed-rock. Plain gray vessels are made with coarse paste and the temper is usually large pieces of crushed-rock. Unpainted white ware sherds are slipped, polished, or both, whereas plain gray sherds are neither slipped or polished.

We identify three types of unpainted white ware: *Early White Unpainted*, *Late White Unpainted*, and *Indeterminate Local White Painted*. “Early” refers to the Basketmaker III and Pueblo I periods (A. D. 600—980), and “Late” refers to the Pueblo II and Pueblo III periods (A. D. 920—1280). The distinguishing characteristics of these types are described below.

***Early White Unpainted* (EWU):** Sherds of this type are characterized by medium to coarse paste, the absence of sherd temper, and relatively thin vessel walls. They are always polished, but usually not slipped (Figures 6.32 and 6.34). To distinguish a polished surface from one that was simply rubbed with water, remember that polishing with a smooth stone will compact a surface, whereas rubbing with water will only smooth it. If slip is present, it will be thin, such that the body clay still shows through.

***Late White Unpainted* (LWU):** Sherds of this type are distinguished by medium to fine paste, fine temper (including crushed sherd temper), and the presence of polish and/or slip (Figures 6.33 and 6.34). The slip is usually thick enough to cover the body clay on the surface.

***Indeterminate White Unpainted* (IND):** These sherds are determined on the basis of paste and temper to be local white ware, but they are too small, damaged, or ambiguous in their characteristics to be assigned to a more specific type.



Figure 6.32. Close-up of the surface of an *Early White Unpainted* sherd. Note the slight polish on the bumpy surface.



Figure 6.33. A *Late White Unpainted* sherd. Note the fine polish and heavy slip.



Figure 6.34. *Early White Unpainted* (bottom) and *Late White Unpainted* (top).

Step 5: Sort, Record and Bag the Unpainted White Ware Sherds by Form and Part

Once you have identified the unpainted white ware sherds as *Early White Unpainted*, *Late White Unpainted*, *Early White Unpainted*, and/or *Indeterminate Local White Unpainted*, sort the sherds in each pile by form and part. All body sherds of the same pottery type, vessel form, and vessel part can then be counted, weighed, labeled, and bagged together. Each rim and handle sherd should be assigned an item number on the label before being bagged individually. Remember to continue the item number sequence you started with the corrugated rim sherds.

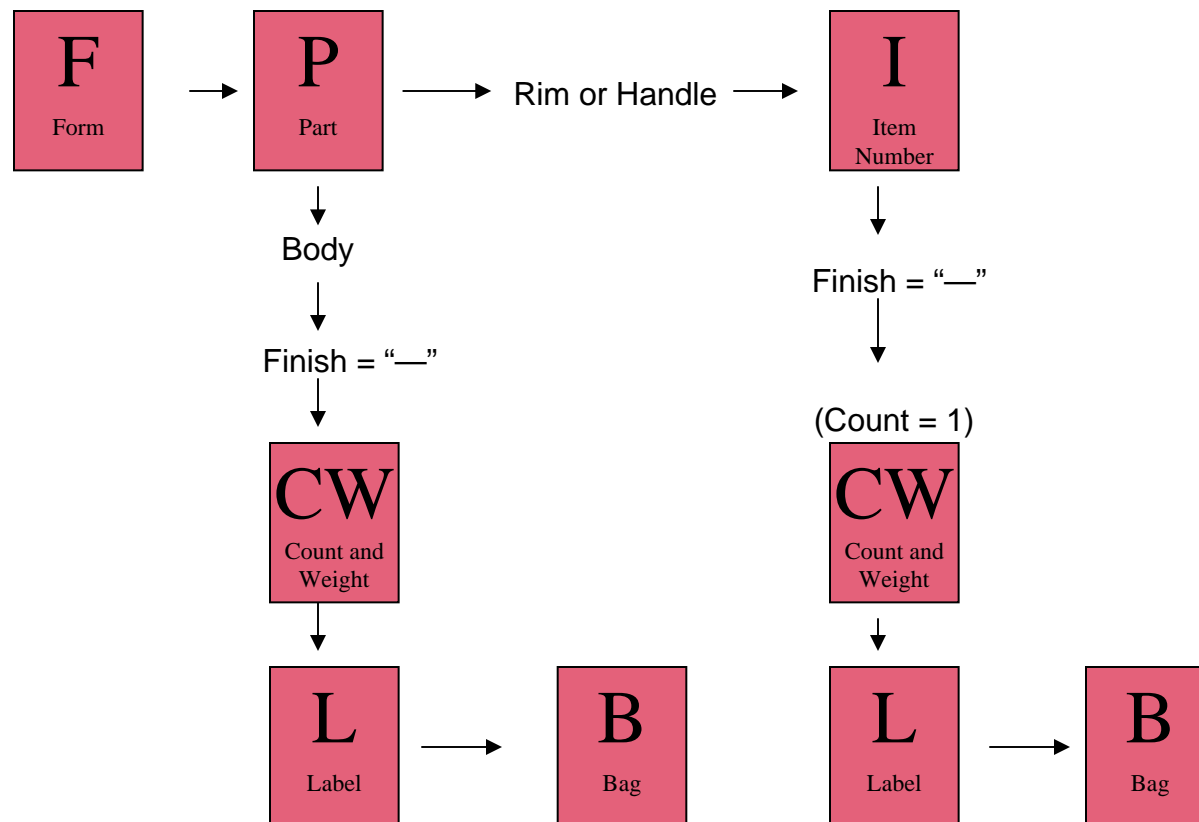

Step 6: Distinguish Local from Nonlocal Red Ware Sherds

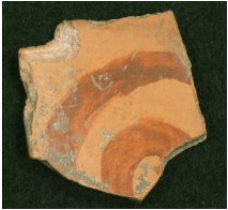

Figure 6.35.
Indeterminate Local Red Painted sherd (San Juan Red Ware).



Figure 6.36.
Indeterminate Local Red Painted sherd (San Juan Red Ware).



Figure 6.37.
Indeterminate Local Red Painted sherd (San Juan Red Ware).

Both local and nonlocal red ware vessels were fired in an oxidizing atmosphere that produced an orange to red surface. Red ware sherds are always polished, but may or may not be painted or slipped. As with white ware vessels, red ware vessels are generally painted, but individual sherds from a vessel may not be.

Red ware sherds that we consider to be local are actually from vessels that were made in southeastern Utah. Called **Indeterminate Local Red Painted (RED)** or **Indeterminate Local Red Unpainted (INR)** in our analysis, they are also known also as San Juan Red Ware, these sherds are treated as local because the part of Utah from which their parent vessels came is within the Mesa Verde culture area. San Juan Red Ware sherds are usually tempered with finely crushed igneous rock, and, if decorated, they have either red paint on an orange background (“red-on-orange”) or black paint on a red background (“black-on-red”) (Figures 6.35–6.37).

Other Red Nonlocal (NON) sherds include Tsegi Orange Ware and White Mountain Red Ware (Figures 6.38 and 6.39). Such sherds are typically tempered with crushed sherds and/or white sedimentary rock, and they often have polychrome designs painted in red, orange, white, and/or black. You will need the assistance of a staff member to determine whether a red ware sherd is local or nonlocal.

Local red ware sherds are analyzed in Steps 7 and 8, and nonlocal red ware sherds are analyzed with other nonlocal sherds in Steps 9–11 (this section).



Figure 6.38. *Other Red Nonlocal* sherds; Tsegi Orange ware.



Figure 6.39. *Other Red Nonlocal* sherds; White Mountain Red Ware.

Step 7: Identify Local Red Ware Pottery Types

Sort the local red ware sherds according to the five types described below. Nonlocal red ware types are described in Steps 9—11.



Figure 6.40. Abajo Red-on-orange



Figure 6.41. Bluff Black-on-red sherd.



Figure 6.42. Deadmans Black-on-red sherd.

Abajo Red-on-orange (ARO): Sherds of this type have designs in red paint on an orange to pink surface (Figure 6.40). In many cases, the designs look as though they were painted with the fingers instead of with a paintbrush. *Abajo Red-on-orange* sherds often exhibit evidence of having been fired in a poorly controlled atmosphere. Painted surfaces are polished but not slipped.

Bluff Black-on-red (BRE): Sherds of this type have designs in black paint on an orange to light red background (Figure 6.41). *Bluff Black-on-red* sherds, too, exhibit evidence of having been fired in a poorly controlled atmosphere. Painted surfaces are polished and most often unslipped. If slip is present, it is so thin that the body clay shows through.

Deadmans Black-on-red (DRE): Sherds of this type have designs in black paint that are comparable to those of Pueblo II, white ware types (*Cortez Black-on-white* and *Mancos Black-on-white*) (Figure 6.42). *Deadmans Black-on-red* sherds exhibit evidence of having been fired in a more controlled atmosphere, and painted surfaces often have a thick slip of deep, brick red color.

Indeterminate Local Red Painted (RED): Local red ware sherds (that is, those tempered with crushed igneous rock) are assigned to this category when the paint color is ambiguous (neither red nor black, frequently the result of misfiring) and/or a sherd is painted but is too small to determine the design configuration or the presence or absence of slip.

Indeterminate Local Red Unpainted (INR): Any unpainted red ware sherd with crushed-igneous temper is assigned to this type.

TP
Temper and
Paste

C
Comments

SP
Slip and
Polish

Step 8: Sort the Local Red Ware Sherds by Part and Form

For each type of local red ware, sort the sherds by form and part, and determine the presence or absence of slip (see Figures 6.43 and 6.44).

Note: “Finish” is documented with regard to slip, *not* paint type on red ware sherds. We established this convention because slip is more important than paint type for dating these sherds. If a *Local Red Ware* sherd is slipped, put “slipped” or an “S” in the finish line of the analysis label, if the sherd is not slipped record “unslipped” or “U” on the analysis label.

C
Comments

TP
Temper and
Paste

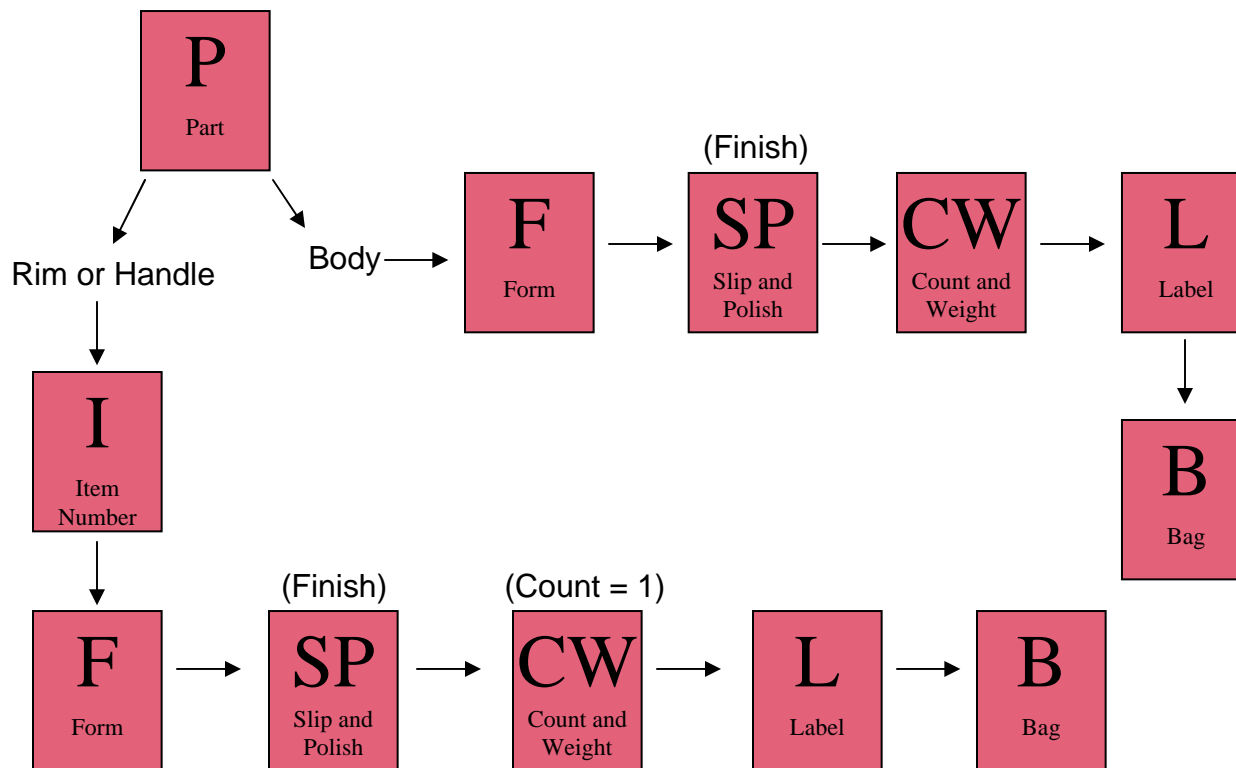

Figure 6.43. Slip seen on the edge of a local red ware sherd.

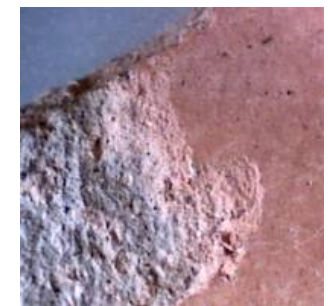

Figure 6.44. Unslipped surface of a local red ware sherd.

Step 9: Identify Nonlocal Sherds (page 1 of 2)

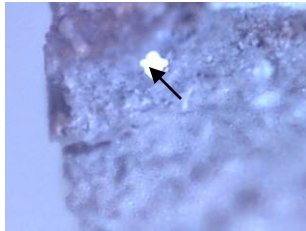

Figure 6.45. Example of sparkly, nonlocal temper.



Figure 6.46. *Other Red Nonlocal* sherds; White Mountain Red Ware.

Nonlocal pottery can be distinguished on the basis of a variety of characteristics, including temper, paste, surface treatment, and/or painted designs. Nonlocal sherds are distinguished only at the level of ware in our analysis system. The general categories we record on the type name and type code lines of the pottery analysis label are as follows:

Other Gray Nonlocal (OGR)
Other White Nonlocal (OBW)
Other Red Nonlocal (ORE)
Polychrome (PLY)

If you are able to identify nonlocal sherds to a more specific nonlocal ware, record the information on the *comments* line of the analysis label.

Nonlocal white wares and gray wares are often identified on the basis of temper (Figure 6.45). Nonlocal red wares are the most common, and they can be identified by their distinctive surface treatment and design style in addition to their temper (Figure 6.46).

Other common nonlocal pottery wares are Chuskan White Ware and Chuskan Gray Ware, Cibola White Ware and Cibola Gray Ware, White Mountain Red Ware, Tusayan White Ware and Tusayan Gray Ware, and Tsegi Orange Ware. These wares are described on the next page.

Note: You might identify more nonlocal sherds later, when you sort painted white ware pottery. If so, you should refer back to these pages.

TP
Temper and
Paste

C
Comments

Fn
Finish

SP
Slip and
Polish

Step 9: Identify Nonlocal Sherds (page 2 of 2)



Figure 6.47. Chuskan White Ware sherds (top) and Cibola White Ware sherds (bottom).

Sort the nonlocal sherds into the categories described on the previous page. If possible, you should also identify the ware category of these sherds and record it on the comments line of the analysis label.

Chuskan White Ware and Chuskan Gray Ware: This pottery has crushed trachybasalt and biotite mica temper which sparkles on the surface of the sherd (Figures 6.47 and 6.48). White ware sherds may have designs in carbon or mineral paint.

Cibola White Ware and Cibola Gray Ware: These wares have sand or crushed sandstone temper. White ware sherds have thin slip, poor polish and designs in a brown to red mineral paint (Figure 6.47). “Slip-slop” (slip that was applied only around the rim) is sometimes seen on the exterior surface of bowls.

White Mountain Red Ware: This ware is identified by a buff to red body clay with large particles of sherd temper (Figure 6.46). Such sherds may have a gray core, but their decorated surfaces have a thick, brick red slip. Polychromes are common and include sherds with white, red, and black paints and/or slips.

Tusayan White Ware and Tusayan Gray Ware: These wares have quartz sand and/or sherd temper. White ware sherds have designs in organic paint, and they lack slip and rim decoration; exterior jar surfaces and interior and exterior bowl surfaces, however, are polished to a pearly white.

Tsegi Orange Ware This ware has sherd temper and designs in black and/or red mineral paints on orange, unslipped, but highly polished surfaces (Figure 6.49).



Figure 6.49. Tsegi Orange Ware sherds.



Figure 6.48. Chuskan Gray Ware sherds.

Fn
Finish

SP
Slip and
Polish

TP
Temper and
Paste

C
Comments

Step 10: Sort Non-local Pottery Types by Part, Form, and Finish

Sort each type of nonlocal pottery identified by part, form, and finish. For painted white ware sherds, finish is determined on the basis of paint type; for local red ware sherds, finish is determined on the basis of slip.

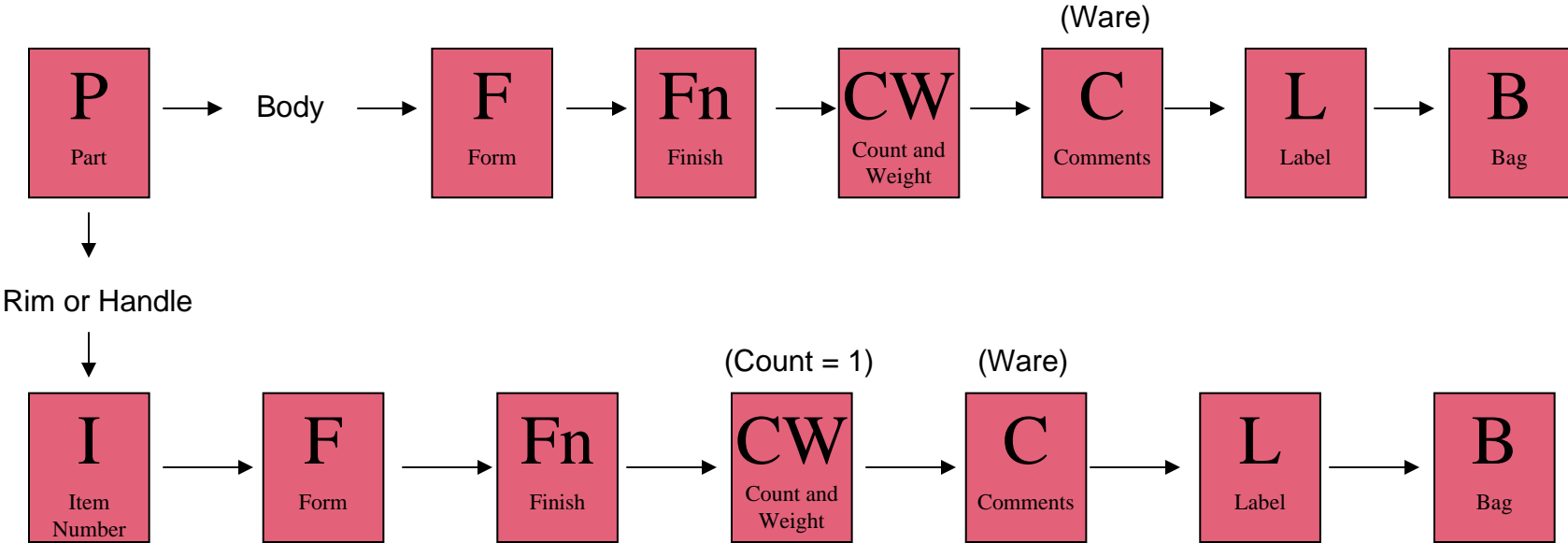

Note: You should keep these bags handy. You may have to add to them because you may find more nonlocal pottery in the painted sherd bag

Step 11: Identify, Record, and Bag Unknown Pottery

The category “Unknown pottery” includes all sherds that are too small or too damaged to be placed into one of the other four piles of “other pottery.” If you can identify such sherds as gray, white, or red ware, record the appropriate code as listed below; if you cannot, record the sherd(s) as simply “*Unknown Pottery*” (UNP):

Unknown Gray (UNG)
Unknown White (UNW)
Unknown Red (UNR)

Within each unknown type sort the sherds by form, part, and finish, if possible. Be sure to assign item numbers to rims and handles.

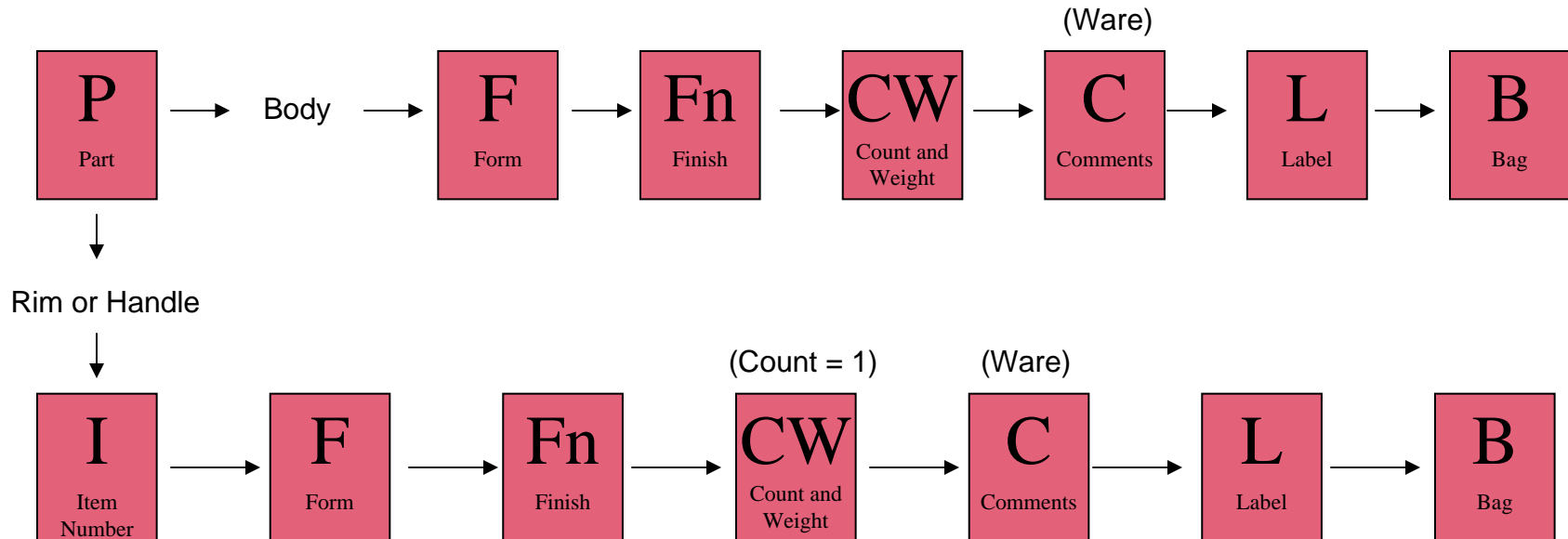

Section C: Painted White Ware Pottery

The flowchart below summarizes the steps you'll follow when analyzing a bag of painted pottery. Beginning with Step 1, this section, you will first sort sherds by vessel part—that is, by rim, handle, and body sherds. Then you'll analyze each "part" group in a specific sequence. First rim sherds, and then handle sherds, are carried through Steps 2–9. Remember that each rim and handle is assigned an item number and is analyzed, labeled, and bagged individually. Body sherds, which are analyzed last, are not given item numbers, so all body sherds that can be fully described using the same label (that is, all the sherds are of the same type, form, and finish) are recorded, counted, weighed, and bagged together. As you can see from the chart, the analysis of painted pottery involves repeating a number of sequential steps, which means that you will have to work through the following pages several times as you analyze any given bag.

Note: If you think you have any nonlocal sherds in your bag of painted pottery, refer to Step 9, Section B and get help from a staff member.

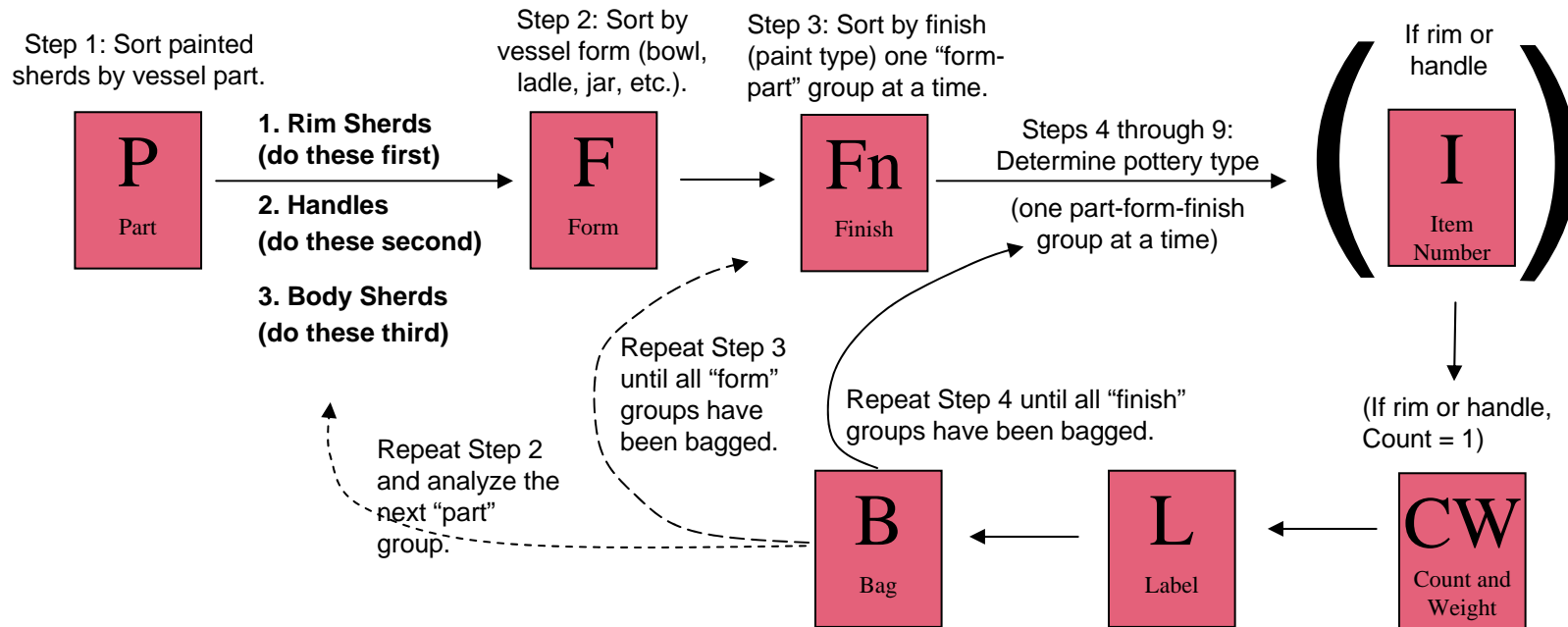

Step 1: Sort Painted White Ware Sherds by Part

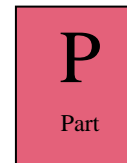

Sort the painted white ware sherds into the three groups below:

Rim Sherds

Have one finished edge.



Analyze all rim sherds *first*,
(Steps 2–9).

Handle Sherds

Can be broken on one or both ends or can have a portion of the vessel body attached to one or both ends. Body sherds that have evidence of a handle attachment should also be included in this group.



Analyze handle sherds *second*
(Steps 2–9).

Body Sherds

All edges will be broken.

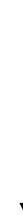

Analyze body sherds last
(Steps 2–9).

Notes:

1. Remember, each rim and handle sherd is given an item number and is labeled and bagged individually.
2. Rims “trump” handles. When a rim sherd has a partial handle or handle attachment, it is recorded as a “rim,” and the presence of a partial handle or handle attachment is noted on the Comments line of the analysis label.

Why Analyze Rim Sherds First?

- Painted rim sherds usually provide present more-diagnostic information than do body and handle sherds. They, therefore help novices learn our pottery typology.
- Rim sherds are given item numbers and analyzed one at a time. Analyzing rim sherds is therefore simpler than analyzing body sherds, especially when one is learning pottery analysis.

Step 2: Sort the “Part” Group by Form

Sort the “part” group you are working with into the “form” groups described below. For more information on pottery vessel forms, see the “Pottery Universals.”



Note: Be sure to distinguish between kiva jars and seed jars, between ladles and dippers, and between mugs and pitchers on the Comments line of the analysis label.

1. Bowl

- Paint, polish, and/or slip are visible on the interior surface.
- If paint, polish, and/or slip are also present on the exterior surface, they will usually not be as well executed as on the interior.

2. Ladle and Dipper

- The nonhandle portion of the vessel is shaped like a bowl, but with tighter rim curvature.
- Surface treatment is like that seen on bowls.
- Some rim sherds show use wear on the outside edge, the result of the “bowl” portion of the vessel being used as a scoop.
- Evidence of a handle or handle attachment may be present.
- Ladle handles are long and straight: dippers in their entirety are shaped like gourds what have been cut in half longitudinally.

3. Jar (undifferentiated)

- Paint, polish, and slip are on the exterior surface only. Scrape marks are preserved on the interior surfaces.
- Ollas, which have an upright neck, small opening, everted rim, and horizontal lug handles, are included in this category.
- The interior surface of olla necks may be slipped immediately below the rim.
- Other jar sherds that cannot be further distinguished are included here.

4. Mug and Pitcher

- Mugs are small and have straight upright sides, a flat rim and base, and a thin, vertical handle.
- Pitchers have a globular base and a straight neck, like a gourd with the stem cut off.
- The vessel’s rim, handle, and exterior surface are often slipped, polished, and painted with intricate, small-scale designs.

5. Kiva and Seed Jar

- A rim is needed to distinguish these vessel forms from other jar forms.
- Kiva jars and seed jars are spherical and have a circular opening.
- A seed jar has a simple rim; a kiva jar rim has a lip and seat for a lid.

6. Canteen

- A rim is needed to distinguish canteens from other jar forms.
- Canteens have a short neck, an opening small enough for a person’s lips to fit around (< 5 cm), and small, loop handles to which a strap can be attached.

7. Other

- Unusual or uncommon forms, such as effigy vessels, jar lids, feather boxes, cylinder jars, etc.
- Consult a staff person if you think you have a sherd from an unusual vessel form.

8. Unknown

- Use only when vessel form cannot be determined.

Next, walk each “part-form” group through Steps 3 through 9 before returning to this step for the next “part” group.



Step 3: Sort One “Part-Form” Group by Finish



“Finish” refers to the kind of paint that was used to produce the designs on painted white ware pottery. Two kinds of paint were used by the ancestral Pueblo people:

•**Mineral Paint:** This type of paint consists of compounds of iron oxide derived from rocks with high iron content.

•**Carbon Paint:** This type of paint type consists of carbonized sugars derived by boiling the stems and leaves of specific plants.

In our analysis, you have four options for finish: mineral paint, carbon paint, mixed paint, and indeterminate paint. Before performing this step, study the information on the Finish pages of the universals section. Be sure to have a staff person check your sort!

Sort one of your “part-form” groups by finish, then run each “part-form-finish” group through Steps 4–9 before returning to this step for the next “part-form” group.



Step 4: Sort One “Part-Form-Finish” Group by Pottery Type

Figure 6.50 is a “decision tree” designed to help you sort out the various typological options for painted sherds derived from local white ware vessels. The type code and time span of manufacture are listed with each type name, and the enumerated steps (beginning with Step 5) guide you to specific instructions and criteria on the following pages. The pottery types we use include specific “traditional” types that have a long history of use, but they also include a number of more-general (and therefore less-diagnostic) “grouped” types defined by our staff to categorize sherds that are too small or too ambiguous to be assigned to one of the more specific types. An example of a specific, traditional type is *McElmo Black-on-white*; an example of a more general grouped type is *Pueblo III White Painted*. The most specific type to which a given sherd can be identified is the one we record during analysis. Thus, for example, it is understood that a sherd typed as *McElmo Black-on-white* (most specific) is also a *Pueblo III White Painted* sherd (less specific) and a *Late White Painted* sherd (least specific). In this case, “McElmo Black-on-white” and “EBW” would be recorded on the type name and type code lines of the pottery analysis label. See also Chapter 5 for detailed descriptions of pottery wares and types.

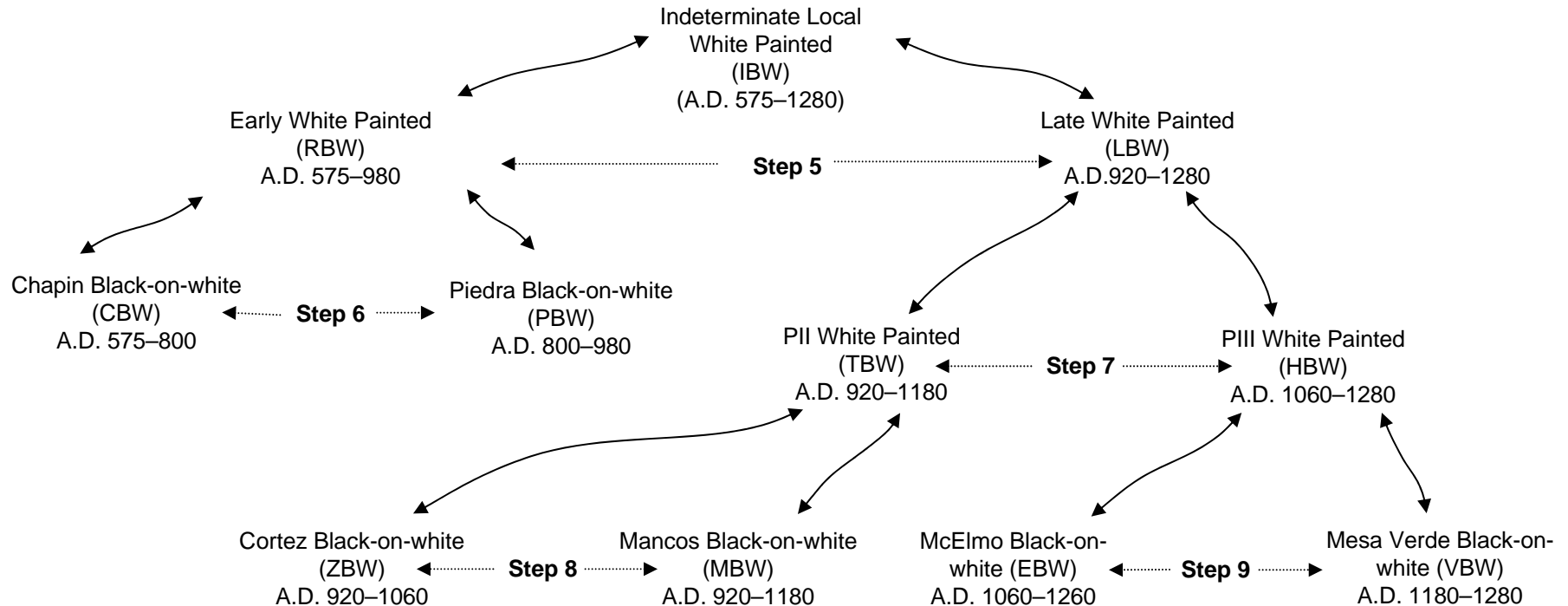

Figure 6.50. Pottery-type decision tree for painted white wares.

Step 5: Distinguish *Early White Painted* from *Late White Painted* (page 1 of 2)

Early White Painted (RBW)

- **Surface Treatment (Slip/Polish):** Vessels may show evidence of having been wetted and rubbed with the hands during manufacture, producing uneven, undulating surfaces. Slip varies from nonexistent to thin and watery. Polish, if present, will be uneven and confined mostly to the high parts of the uneven surface.
- **Paste:** Usually coarse, indicating minimal processing (grinding) of the clay; identifiable by a rough cross section where the break occurs.
- **Temper:** Crushed igneous rock or sand. Temper particles are relatively large, they often protrude from sherd surfaces, and they are visible to the naked eye.
- **Finish:** Usually mineral.

Bowls and Ladles only . . .

Interior/Exterior Surface Treatment: If slip and/or polish are present, they will occur only on the interior surfaces.

Late White Painted (LBW)

- **Surface Treatment (Slip/Polish):** Vessels were scraped with a tool during manufacture, resulting in surfaces that range from undulating to uniform, depending on how well they were scraped. The slip is usually thicker and more evenly applied than on early white wares; polish is uniform and well done.
- **Paste** Usually fine, indicating more-extensive processing of the clay; identifiable by a smooth cross section where the break occurs.
- **Temper:** Most often crushed sherd, but sand and rock were also used. The temper particles are finer than in early white ware sherds often being invisible to the naked eye.
- **Finish:** Mineral, carbon, or mixed.

Bowls and Ladles only . . .

Interior/Exterior Surface Treatment: Both surfaces are usually slipped and polished, but the interior treatment is usually better executed than the exterior treatment.

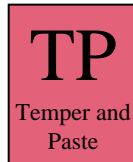

See Figures 6.51 and 6.52 (next page) for examples of some of these attributes.

Step 5: Distinguish *Early White Painted* from *Late White Painted* (page 2 of 2)

Figure 6.51. *Early White Painted* (RBW) surface treatment.

Surface is poorly smoothed and uneven.



If present, slip is thin and watery; polish is uneven.

Temper protrudes above surface.

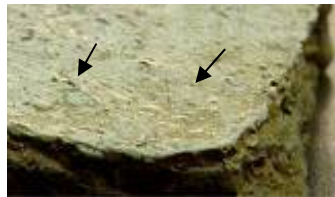

Figure 6.52. *Late White Painted* (LBW) surface preparation and treatment.

Surface can be well scraped and even, like here, or poorly scraped and undulating.



Slip can be thick and heavy; polish is even, often resulting in a shiny surface.

Temper seldom protrudes above surface.



You should now determine whether or not the sherds you have placed in each category can be subdivided further (refer to Step 4, this section). Any sherds that cannot be categorized further will be recorded using the type names and codes on this page.

Step 6: Distinguish *Chapin Black-on-white* from *Piedra Black-on-white* (Page 1 of 2)

HINT: The presence or absence of slip can help you differentiate between these two types.

Chapin Black-on-white (CBW)

- **Surface Treatment (Slip/Polish):** Looks like plain gray pottery with paint (usually mineral). Has no slip or polish.
- **Designs:** are usually not oriented in relation to the rim.

Rim decoration, if present, is a solid line for both types.

The following common *Chapin Black-on-white* design motifs (Figures 6.53–6.56) were used to make isolated, “floating” designs on the vessel surface.

Figure 6.53. Narrow, parallel lines, widely spaced and poorly executed.



Figure 6.54. Various forms of “ticks.”

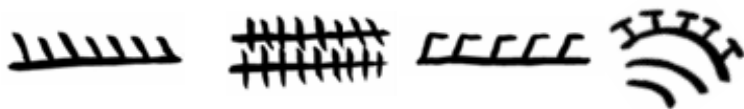

Figure 6.55. Dots, Z's, and S's used as “fillers.”



Figure 6.56. Triangles used occasionally as the only solid painted area.



See Figures 6.60 and 6.61 (next page) for photographs of *Chapin Black-on-white* and *Piedra Black-on-white* sherds.

Piedra Black-on-white (PBW)

- **Surface Treatment (Slip/Polish):** May have a thin, watery slip and limited polish on the highest parts of the undulating surface. On bowls, only the interior surface has slip and polish.
- **Designs:** are usually oriented in relation to the rim.

The following common *Piedra Black-on-white* design motifs (Figures 6.57–6.59) were used in combination to create “overall” designs on the vessel surface.

Figure 6.57. Narrow, parallel lines, closely spaced and poorly executed.



Figure 6.58. Lines with “ticks” and lengthwise “squiggles.”



Figure 6.59. Various triangle designs.



Step 6: Distinguish *Chapin Black-on-white* from *Piedra Black-on-white* (page 2 of 2)

Figure 6.60. Examples of *Chapin Black-on-white* (CBW) sherds.



Figure 6.61. Examples of *Piedra Black-on-white* (PBW) sherds.



CW
Count and
Weight

L
Label

B
Bag

You should count, weigh, label, and bag any *Chapin Black-on-white* (CBW) or *Piedra Black-on-white* (PBW) sherds now, using the appropriate type names and codes. Any sherds that cannot be assigned to these more specific categories should be recorded simply as *Early White Painted* (RBW).

Step 7: Distinguish *Pueblo II White Painted* from *Pueblo III White Painted* (page 1 of 2)

Pueblo II White Painted (TBW)

- **Rim Shape:** Tapered and pointed or rounded, often shaped with the hands.
- **Rim Decoration:** If present, a thin, solid line around the circumference of the rim is typical.
- **Thickness:** Usually thinner than PIII White Painted (4–5 mm).
- **Surface Treatment:** Varies greatly, from hand-built without the aid of a scraper to well scraped. Slip varies from thin and watery to thick and creamy; polish may vary from poorly polished to highly polished.

Bowls and ladles only . . .

- **Interior/Exterior Surface Treatment:** Both surfaces may be slipped and polished, but the interior surface is usually treated with much more care.
- **Bowl Shape:** U-shaped—that is, shaped like the base of an inverted cone, producing fairly straight, sloping sides and a flattened bottom (Figure 6.62).

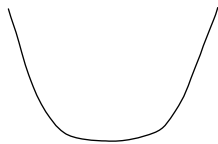
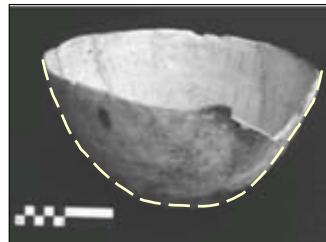

Figure 6.62. Pueblo II bowl shape.



Pueblo III White Painted (HBW)

- **Rim Shape:** Slightly tapered to untapered; flattened on top; usually shaped with a scraper.
- **Rim Decoration:** If present, ticks, dots, and other simple, repeating designs are typical.
- **Thickness:** Usually thicker than Pueblo II White Painted (6–7 mm).
- **Surface Treatment:** Vessels are generally well scraped. Slip is usually thick and crazed (crackled), completely obscuring the body clay; surface is also well polished to a smooth, lustrous finish.

Bowls and ladles only . . .

- **Interior/Exterior Surface Treatment:** Both surfaces are well slipped and polished, and the care given to the exterior surface is more similar to that given the interior surface.
- **Bowl Shape:** Hemispherical, that is, shaped like a sphere that has been cut in half, producing uniformly curved sides that are vertical at the rim and horizontal at the base (Figure 6.63).

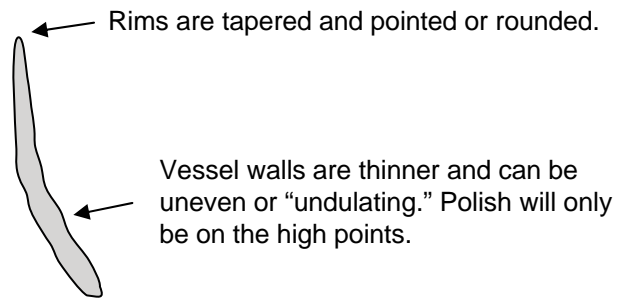

Figure 6.63. Pueblo III bowl shape.

See Figures 6.64 and 6.65 (next page) for examples of some of these attributes.

Step 7: Distinguish *Pueblo II White Painted* from *Pueblo III White Painted* (page 2 of 2)

Figure 6.64. *P II White Painted* (TBW) characteristics.



Paint on rim, if present, is a solid line.

Note that the exterior surface is not as well prepared as the interior surface.

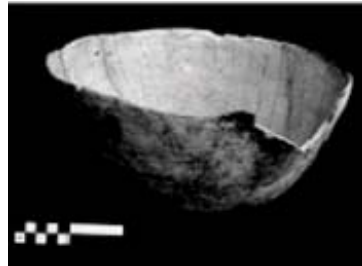
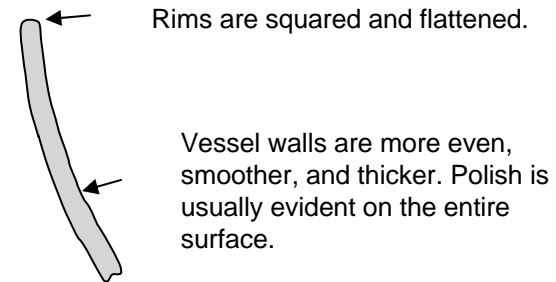
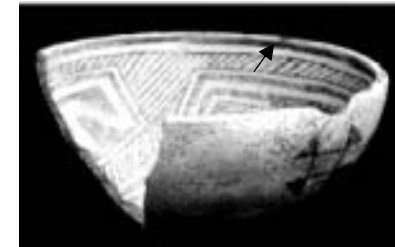

Figure 6.65. *P III White Painted* (HBW) characteristics.



Paint ticks on rim are common.

Both the interior and the exterior surfaces are well-slipped and well-polished. Photo by David M. Grimes



You should now determine whether the sherds you have placed in each category can be subdivided further (refer to Step 4, this section). Any sherds that cannot be categorized further will be recorded using the type names and codes on this page.

Step 8: Distinguish *Cortez Black-on-white* from *Mancos Black-on-white* (page 1 of 2)

Cortez Black-on-white (ZBW)

- **Finish:** Always has mineral paint.
- **Surface Treatment:** Decorated surfaces are usually well scraped, even, and smooth. Decorated surfaces are well slipped and polished.
- **Design:** Overall designs composed of multiple geometric elements in fluid patterns. Examples are given below (Figures 6.66–5.69).

Figure 6.66. Multiple, narrow, parallel lines, closely spaced and generally well executed. “Squiggles” are also common.



Figure 6.67. Lines can include the following:
cross ticking lengthwise “squiggle” “squiggle” hachure

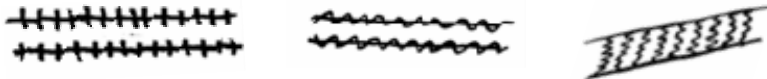

Figure 6.68. Circular scrolls and interlocking scrolls are very common.



Figure 6.69. Triangles with tick marks along the hypotenuse are common, but this design can also occur on *Mancos Black-on-white* sherds.



See Figures 6.74 and 6.75 (next page) for photographs of *Cortez Black-on-white* and *Mancos Black-on-white*.

Mancos Black-on-white (MBW)

- **Finish:** Can have mineral, carbon, or mixed paint.
- **Surface Treatment:** Surface preparation varies greatly, from unscraped to basket-impressed to corrugated to well-scraped. Slip and polish vary greatly, from unslipped and unpolished to well slipped and polished.
- **Design:** Overall and band designs composed of geometric elements in geometric patterns. Examples are given below (Figures 6.70–6.73).

Figure 6.70. Narrow and broad parallel lines form shapes or patterns, including parallel lines with hachure.



Figure 6.71. Fret motifs of various shapes are common and can be solid or hatched, triangular, rectilinear, or curvilinear.

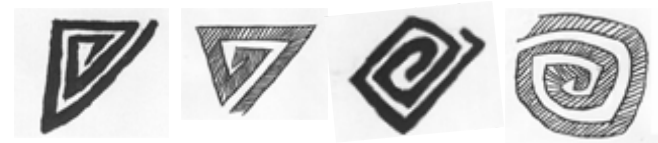
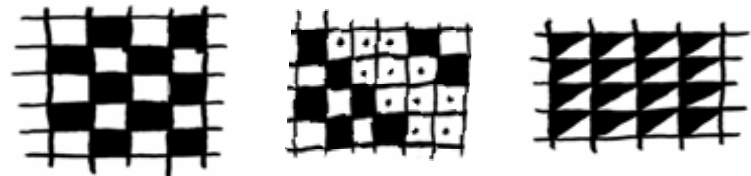

Figure 6.72. Various triangle motifs are common.



Figure 6.73. Checkerboard patterns are common, but they can also occur on *Cortez Black-on-white* and *McElmo Black-on-white* sherds.



Step 8: Distinguish *Cortez Black-on-white* from *Mancos Black-on-white* (page 2 of 2)

Figure 6.74. *Cortez Black-on-white* (ZBW) sherds.



The high quality of the slip and polish can help you distinguish *Cortez Black-on-white* from *Mancos Black-on-white*.

NOTE: A Pueblo II White Painted sherd with carbon paint is typed as *Mancos Black-on-white* because *Cortez Black-on-white* can only have mineral paint.

Figure 6.75. *Mancos Black-on-white* (MBW) sherds.



CW
Count and
Weight

L
Label

B
Bag

You should count, weigh, label, and bag any *Cortez Black-on-white* (ZBW) or *Mancos Black-on-white* (MBW) sherds now, using the appropriate type names and codes. Any sherds that cannot be assigned to these more specific categories should be recorded simply as *Pueblo II White Painted* (TBW).

Step 9: Distinguish *McElmo Black-on-white* from *Mesa Verde Black-on-white* (page 1 of 3)

McElmo Black-on-white (EBW)

- **Finish:** Can have mineral, carbon, or mixed paint.
- **Bowl Exterior Decoration:** Rare.
- **Designs:** *McElmo Black-on-white* can be thought of as a Pueblo III sherd with *Mancos Black-on-white* designs. Most designs are painted using a single brush (that is, line width is relatively uniform). Characteristics are given below (Figures 6.76–6.79).

Figure 6.76. Common motifs include stepped triangles, solid frets, and checkerboards.



Figure 6.77. A single, wide framing line parallel to the rim and with attached motifs that hang down is a common design.



Figure 6.78. Designs often consist of narrow or wide parallel lines made using a single brush. Designs have “true” backgrounds—that is, the white area is the “canvas” on which the design is applied; the white area does not make a distinct pattern of its own.



Figure 6.79. When rims are decorated, they have simple, repeating ticks.



Mesa Verde Black-on-white (VBW)

- **Finish:** Can have mineral, carbon, or mixed paint; carbon is most common.
- **Bowl Exterior Decoration:** Common on very late vessels.
- **Designs:** Complex designs that were painted using brushes of different widths (that is, line width varies). Characteristics are given below (Figures 6.80–6.82).

Figure 6.80. Banded designs parallel to the vessel rim are composed of several elements:

- A wide framing line at the top and bottom in conjunction with several narrow framing lines.
- A repetitive design between the framing lines.
- Design in the band has an active background—that is, the white area has a distinct shape or design of its own.
- Painting requires the use of brushes of different widths.



Figure 6.81. Hatching is used as a background filler to accentuate the solid design elements in a banded or all-over layout.



Figure 6.82. Rims can be decorated with simple repeating ticks or with more complex patterns involving gaps or lines.



See Figures 6.83 and 6.84 (next page) photographs of *McElmo Black-on-white* and *Mesa Verde Black-on-white* sherds.

Step 9: Distinguish *McElmo Black-on-white* from *Mesa Verde Black-on-white* (page 2 of 3)

Figure 6.83. *McElmo Black-on-white* sherds.



Single brush size (that is, line width is relatively uniform)

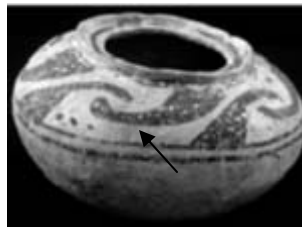

“True” background (the white area doesn’t form a distinct pattern). Photo by David M. Grimes

Figure 6.84. *Mesa Verde Black-on-white* sherds.

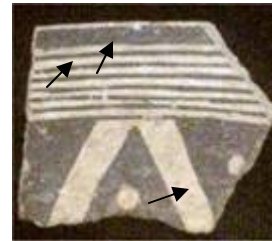

Multiple brush sizes (that is, line width varies)

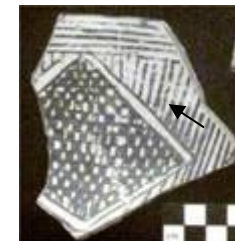

“Background hachure” around a solid design

“Active” background (the white area has a shape or pattern of its own)



See figures 6.85–6.88 (next page) for photographs of bowl exterior designs on *Mesa Verde Black-on-white* bowls.

Step 9: Distinguish *McElmo Black-on-white* from *Mesa Verde Black-on-white* (page 3 of 3)

Examples of exterior designs on *Mesa Verde Black-on-white* bowls

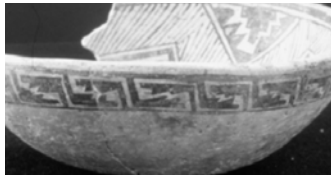

Figure 6.85. Repeating band design. Photo by David M. Grimes



Figure 6.86. "Textile" design. Photo by David M. Grimes



Figure 6.87. Parallel lines. Photo by David M. Grimes



Figure 6.88. Animal figures. Photo by David M. Grimes

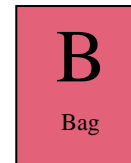
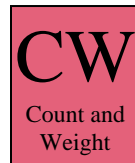

You should count, weigh, label, and bag any *McElmo Black-on-white* (EBW) or *Mesa Verde Black-on-white* (VBW) sherds now, using the appropriate type names and codes. Any sherds that cannot be assigned to these more specific categories should be recorded simply as *Pueblo III White Painted* (HBW).

Section D: Pottery Universals

The topics in the following pages are called “universal” because they come into play during several different steps of pottery analysis. For example, vessel form needs to be recorded for all sherds. Instead of presenting the same information about vessel form every time it is relevant, this guide uses a red box containing a letter code (in this example, F or “Form”) to indicate the specific universal page that should be consulted. The pages in this section have the identifying box prompt in the lower right-hand corner. On many pages in this chapter you will see one or more prompts, which refer you to specific universal pages contained in this section.

The universal topics are arranged alphabetically according to code letters:

Bagging, **C**omments, **CW** Count and **W**eight, **F**orm, **Fn** Finish, **I**tem Number, Analysis **L**abel, **P**art, **SP** Slip and **P**olish, and **TP** Temper and **P**aste.

You may find it helpful to peruse all the universal topics before beginning pottery analysis.

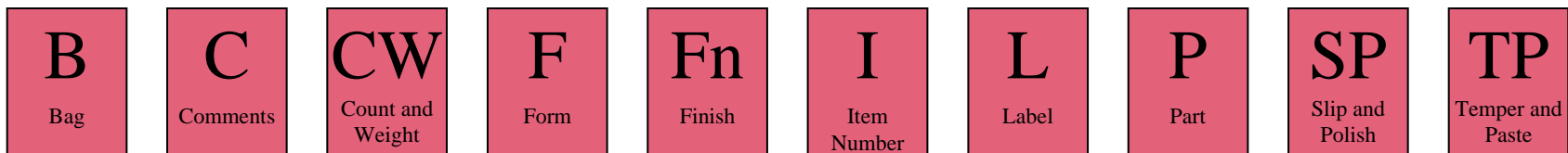

Universal Section

How to Bag Pottery

After being sorted by form, part, finish, and type, all pottery is bagged and labeled. If an artifact has been given an item number, as is done with rim sherds and handles, then it is bagged individually. Otherwise, all body sherds from a bag of “bulk sherds, large” that can be described using the same analysis label are counted, weighed, and bagged together. For example, all jar (form) body (part) sherds with carbon paint that are identified as *Mancos Black-on-white* (type) should be counted, weighed, and bagged together.

Place the sherds inside an appropriately sized bag, one in which the sherds will be neither stuffed nor “swimming.” The analysis label is placed in the bag so that it can be read from the outside. When bagging a sherd that has been assigned an item number, be sure the decorated face of the piece is not obscured by the analysis label. This will facilitate checking during data entry.

To close the bag, simply fold its top over (unless the bag is very full, in which case, you should use a twist tie). When you complete the analysis of a bag of large bulk sherds, all the smaller bags you generate will be nested back inside the original bag containing the field specimen (FS) label (Figure 6.90). Be sure to place the FS label facing out, so it can be read from the outside. This larger bag will be twist-tied shut. REMEMBER, YOU ONLY TWIST TWICE!

Crow Canyon uses archival polyethylene bags. The labels are printed on acid-free archival paper.



Figure 6.89. A bag of *Indeterminate Local Corrugated Gray* jar body sherds.



Figure 6.90. Bagged sherds. Larger, multiple-sherd bags are at the top; the bottom row consists of individual sherds that were assigned item numbers. All will be placed back inside the original bag (left) with the FS label.

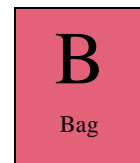

Universal Section

Things to Record in Comments (page 1 of 3)

Be sure to record the following observations on the comments line of the analysis label:

Handle Attachments: Any portion of a handle that attaches to a mug, jar, or ladle (Figure 6.91). “Handle” should also be entered on the line for “part”, unless the sherd is also a rim, in which case, “rim” should be entered for “part” and the presence of a handle noted only in the comments.

Repair Holes: Small holes that were drilled into the side of a vessel to stop or repair a crack in the pot (Figure 6.92). Usually only one repair hole is found on a sherd. The conical or biconical shape of a repair hole distinguishes it from a hole that was made when the parent vessel was manufactured.

Basket Impressions: Impressions made in the malleable clay when the coils were pressed against the inside walls of a basket during the vessel manufacture (Figure 6.93). When the vessel dried and was removed from the basket, the basket weave pattern was impressed on the exterior surface of the vessel. Remember that each basket-impressed sherd gets an item number, even if it is a body sherd.

Corrugated White Ware: Be sure to note when corrugation is observed on a white ware sherd vessel with slip, polish and/or paint (Figure 6.94). Paint “trumps” corrugation, so analyze such sherds as white ware, and record the presence of corrugation in the comments.

Refit/Recent Break: “Refit” is the term used to describe pieces of pottery that fit back together. If two or more sherds fit together and appear to have been broken recently (that is, there is no ground-in dirt in the cross sections that fit together), you should count these sherds as *one piece* and write “N sherds refit, recent break” on the comments line of the analysis label. If the sherds are not recently broken, they should be counted separately, like all other sherds, and “N sherds refit” should be entered in the comments.



Figure 6.91. Handle attached to a rim sherd.



Figure 6.92. Repair hole.



Figure 6.93. Basket impressed sherd.



Figure 6.94. White ware vessel with corrugated neck. Photo by David M. Grimes



Universal Section

Things to Record in Comments (page 2 of 3)

Fugitive Red: This is a red pigment, usually powdered hematite, that was applied to the surface of some vessels after they were fired (Figure 6.95). This “fugitive” pigment tends to wash away, so such sherds should not be washed.

Trachyte or Biotite Temper: You may occasionally see fragments of biotite mica or trachyte sparkling on the surface or in the cross-section of a sherd (Figure 6.96). This usually indicates that the parent vessel was made with non local raw materials from the Chuska mountains. Such sherds can often be identified by beginning analysts (but you must be alert)!

Kiva or Seed Jar: On the form line of the analysis label, both of these are described as kiva jars; therefore you must distinguish whether the sherd is from a kiva or a seed jar in the comments.

Ladle or Dipper: On the form line of the analysis label, both of these are described as ladles; you therefore must record “dipper” in the comments if the sherd is from a container with a half-gourd shape.

Misfired/Oxidized: We describe sherds as “misfired” if it is apparent that something went wrong during the firing of the parent vessel. Sherds that are warped, discolored, vitrified (glassy or bubbly), or pitted are all considered misfired. Oxidization occurs when the clay of a vessel absorbs too much oxygen when it is being fired. The oxygen reacts with the iron in the clay and “rusts,” or discolours, the vessel, usually resulting in a buff, pink, red, or reddish brown color. This discoloration will be visible throughout the sherd (including the paste in cross section).



Figure 6.95. Sherd with fugitive red pigment.

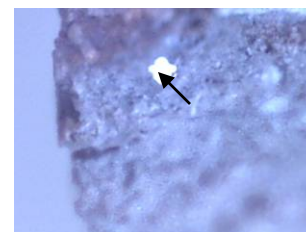

Figure 6.96. Biotite mica temper.



Universal Section

Things to Record in Comments (page 3 of 3)



Figure 6.97. Sherd from the base of a corrugated jar.

Corrugated Base Sherds: Any sherd that preserves the exterior center of the base of a corrugated vessel (Figure 6.97) should be given an item number and identified in comments. If you can tell the direction (clockwise, counter clockwise) of the coil, record this in your comment as well. The comment could say “Corrugated base, clockwise”, for example.

Other Vessel Forms: These include miniatures, effigies, feather boxes, etc. They are identified as “other” on the form line of the analysis label, but if possible you should also describe the specific form in the comments.

Use Wear: This is wear that results from repetitive rubbing, grinding, or some other action that smoothes and weathers the slip, paint, and/or paste of a vessel while it is a complete vessel. Use wear in this context is distinct from modification that occurred on an individual sherd after the parent vessel broke (see the definitions of modified sherds and shaped sherds in Chapter 4).

Some of the items listed above may be difficult to identify. Always seek the advice of a staff member if you think you should record a comment. However, *please* note anything that seems unusual or noteworthy.



Universal Section

How to Count and Weigh Sherds

Every sherd that passes through the lab is counted and weighed, either individually or as a group. Each sherd that is assigned an item number is counted and weighed individually. In contrast, all sherds that do not receive item numbers and that can be described using a single analysis label are counted and weighed together.

•**Counting Tips:** When counting large numbers of sherds, especially corrugated jar body sherds, it is often helpful to place the sherds in piles of 10 or 100 to help you keep track of the number. That way, you won't have to start over if you lose count! Also, any sherds that refit across fresh breaks should be counted as a single sherd, because fresh breaks occur only during excavation or lab processing (see "Refit/Recent Break" on the Comments page).

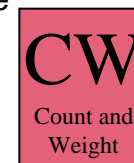

Figure 6.98. Using the scale

•**Weighing Tips:** Before you weigh anything, make sure that the bubble in the circular level at the back of the scale is centered. If it is not, notify a staff member. You should also make sure the scale reads 0.0 g before proceeding (Figure 6.98). To turn on and zero the scale, press the long silver bar on the front. The scales are very sensitive and will give inaccurate or unstable readings if you lean on the table. Round all weights to the nearest tenth of a gram, or to the first placeholder after the decimal.

•**Weights of Individual Sherds:** Place the sherd directly on the scale and record the weight.

•**Weights of Multiple Sherds:** It is easiest to weigh large groups of sherds after bagging them, while accounting for the bag weight. To do this, you must first tare the scale. Find an empty plastic bag of the same size and thickness as the one you used for the sherds, place the empty bag on the scale, and then press the reset bar. This will reset the scale to 0.0 with the bag on the tray, and will return the negative bag weight when you remove the empty bag. You may then place the bag of sherds on the scale and record the weight, which will now be of the sherds, less the weight of the bag.



Universal Section

Pottery Forms (page 1 of 2): Common Forms

Jar

All plain gray ware and corrugated gray ware sherds are assigned to the jar category, unless you have a rim sherd that is curved in such a way that it could only be from a bowl or some other vessel form. White ware and red ware sherds are assigned to the jar category on the basis of curvature and the absence of slip, polish and paint on the interior surface. Marks made when the wet clay coils were scraped during manufacture will often be visible on the interior surface of a jar sherd because jar interiors were not subsequently polished or slipped. Figure 6.99 shows examples of various jar shapes.



Figure 6.99. Jar shapes.

Bowl

White ware and red ware sherds are recorded as bowls on the basis of curvature and the presence of slip, polish, and/or paint on the interior surface. A gray ware sherd should be assigned to this category only if it is a rim and is curved in such a way that it could only be from a bowl. Figure 6.100 shows examples of bowl shapes.



Figure 6.100. Bowl shapes.

Mug/Pitcher

White ware sherds from small, cylindrical vessels with single handles are characterized as mug sherds. Mugs often have a well-prepared and intricately painted exterior and a thin, well-prepared strap handle (Figure 6.101). The top part of the interior of a mug is sometimes slipped and polished.

Sherds from pitchers (mugs with a gourd shape) are also included in this category. Be sure to note in the comments if a mug sherd is from a pitcher.

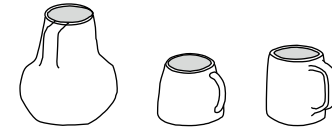

Figure 6.101. Pitcher (left) and mug (center and right) forms.

Ladle/Dipper

Two kinds of white ware sherds are assigned to this category:

- A rim sherd from an “open” vessel form with tight curvature (15 cm or less) and significant use wear on the exterior edge of the rim.
- A sherd from an “open” vessel with all or a portion of a handle attachment on the exterior surface.

Sherds from dippers (ladles with a half gourd shape) are also included in this category. Be sure to note in the comments if a ladle sherd is from a dipper. Also, note any use-wear present. Figure 6.102 illustrates the difference between ladles and dippers.



Figure 6.102. Ladle (left) and dipper (right) forms.



Universal Section

Pottery Forms (page 2 of 2): Rare Forms

Kiva Jar and Seed Jar

These are white ware and redware jars with small openings and no necks (Figure 6.103). You must have a rim to be able to identify these forms. Seed jar rims are simple and unembellished, whereas kiva jar rims have a lip around the jar opening that was designed to help seat a pottery lid. Be sure to write in the comments whether a sherd assigned to this category is a “kiva jar rim,” a “kiva jar lid,” or a “seed jar rim.”

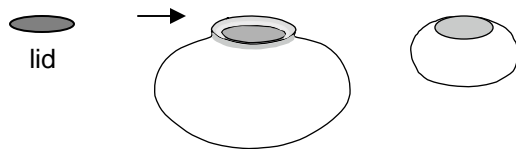

Figure 6.103. Kiva jar (left) and seed jar (right) forms.

Canteen

Rim sherds from white ware jars are recorded as canteens if they meet the following criteria: they appear to be from vessel with openings measuring less than 5 cm in diameter, there is evidence of a short vessel neck; and/or there is evidence of at least one handle that is suitable for the attachment of a suspension cord (Figure 6.104)



Figure 6.104. Canteen.

The vessel form category (words), not the form code, should be written on the analysis label.

Other

This category consists of sherds that are definitely not from a jar or a bowl and that are clearly from other vessel forms that can be named—for example, boxes, gourd-shaped vessels (that are not ladles or pitchers), effigy vessels, and miniature vessels (Figure 6.105). Be sure to note the specific form in the comments.



Figure 6.105. Other forms and shapes.

Unknown

This category consists of sherds for which the vessel form cannot be determined. Most often this category is used when the interior surface of a sherd is missing, making it impossible to determine whether the the sherd is from a jar or a bowl. Sherds with ambiguous or irregular curvature may also be recorded as “Unknown.”

NOTE: Be sure to check with a staff member before recording a vessel form as “Other” or “Unknown.”

SITE: 5MT123
 PD _____ FS _____ Item _____
 Type name _____
 Type code _____
 Form Part _____
 Finish _____ Vessel # _____
 Count _____ Weight _____
 Comments _____

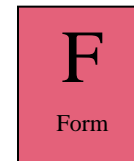

Universal Section

White Ware Finish: Paint Types

NOTE: Finish for red ware sherds is determined on the basis of slip. See the “Slip and Polish” page for more information on red ware finish.

Mineral Paint

- The main ingredient of mineral paint is a finely ground iron oxide derived from specific rocks with a high iron content.
- The ground mineral paint is mixed with water, carbon paint, or other liquid medium for application to the vessel surface (Figure 6.106)..
- Because it is applied as a mixture, mineral paint behaves like an oil paint—that is, it sits upon and covers the vessel surface, producing the following characteristics:

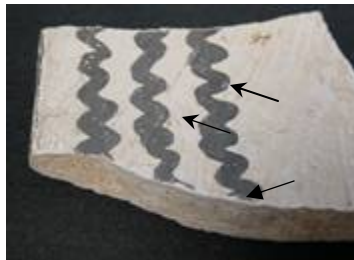

Figure 6.106. Sherd with mineral paint.

- The paint covers the vessel surface but does not soak into it. (Note: The slip is visible under the paint.)
- If the paint is thick, the vessel surface will not be visible through the paint.
- The paint can be dull to shiny, but it is usually “different” than the sheen of the vessel surface.
- The color can vary from black to reddish brown.
- The paint has a fine but grainy texture.
- The paint edges are sharp and do not “bleed.”
- The paint frequently flakes off, exposing the vessel surface underneath.

Mixed Paint and Indeterminate Paint

The *mixed* paint category is used when mineral and carbon paints occur distinctly and separately on the same sherd. It is NOT used when there is a physical “blend” of the two paint types. Mineral paint requires some sort of binder or glue to hold the pigment on the vessel surface prior to firing. In some cases, this binder contains organic pigment, resulting in a paint that exhibits characteristics of both paint types. In this case, the paint type is coded as “mineral.” *Indeterminate* is used when the paint type cannot be determined from the available evidence.

Carbon Paint

- Carbon paint consists of a sugar solution derived by boiling the leaves and stems of specific plants such as Rocky Mountain beeweed (Figure 6.107).
- Because it is a solution, carbon paint behaves like a watercolor or stain, soaking into the vessel surface and producing the following characteristics:

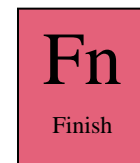

Figure 6.107. Sherd with carbon paint.

- The paint soaks into the vessel surface (note the stained appearance).
- The paint edges are often “fuzzy,” the result of “bleeding” into surrounding unpainted areas.
- Marks from surface preparation are visible through the paint (note the polishing marks visible in both painted and unpainted areas).
- The painted and unpainted areas have the same luster, which is dependent on the degree of polish, not on the properties of the applied paint.
- The color can range from a bluish black to brown.
- The paint can appear “washed out” if it was over-diluted with water before application to the vessel surface.
- The paint can appear “puddled” because gravity pulls the pigment downward as it dries.

Paint is entered on the analysis label as carbon, mineral, mixed, or indeterminate.

SITE: 5MT123	
PD _____	FS _____ Item _____
Type name _____	
Type code _____	
Form _____	Part _____
Finish <input type="text"/>	Vessel # _____
Count _____	Weight _____
Comments _____	



Universal Section

Item Numbers

Item numbers are assigned in numerical sequence within each lot of analyzed pottery assigned a given FS number (usually a bag with a provenience label). These numbers are used to identify sherds for which we will collect additional data after basic pottery analysis is complete. Assigning item numbers during pottery analysis ensures that all future data collected for such sherds will be relatable at the level of the individual sherd. No two sherds in our collections will have the same combination of site, PD, FS, and item numbers.

We assign item numbers to each rim sherd (Figure 6.108), basket impressed sherd (Figure 6.109), handle or handle fragment (Figure 6.110), and corrugated jar base (Figure 6.111).

The sequence of item numbers continues from the first corrugated rim through the last white ware rim in a bag of sherds. You should **not** start a new number sequence when you proceed from corrugated sherds to other sherds and then to painted sherds.

Sherds assigned item numbers are always bagged individually with their own analysis labels.



Figure 6.108. Rim sherd.



Figure 6.109. Basket-impressed sherd.

Once an item number is assigned, be sure to record it on the pottery analysis label and add a comment, if necessary.

SITE: 5MT123		
PD _____	FS _____	Item <input type="text"/>
Type name _____		
Type code _____		
Form _____	Part _____	
Finish _____	Vessel # _____	
Count _____	Weight _____	
Comments _____		



Figure 6.110. Handle fragment.



Figure 6.111. Base of a corrugated jar.

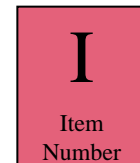

Universal Section

How to Fill Out the Analysis Label

NOTE: You should enter a dash (–) for every label entry that is not applicable for a given sherd or set of sherds. This will document that you have not forgotten to record something that should be recorded!

PD: This is an acronym for “provenience designation number.” Each unique three-dimensional space excavated at a site is assigned a unique number by the field crew. You will find this number should be written on the FS label of your bag.

FS: This is an acronym for “field specimen” number. A unique FS number is assigned to each category of artifact or sample collected from a PD. You will find this number on the FS label of your bag.

Item: This is a number assigned sequentially within an FS to each rim sherd, basket-impressed sherd, corrugated jar base, and handle sherd.

Type Name: The full name of a pottery type.

Type Code: The three-letter code associated with a given type name.

Form: The shape of the parent vessel. Write the form description, not the form code, in this space.

Finish: For painted white ware sherds, paint type is recorded here. For red ware sherds, the presence or absence of slip is recorded. Write the finish description, not the finish code, in this space.

The diagram shows a rectangular form with the following fields and arrows pointing to them:

- SITE:** 5MT123 (arrow points to the site number)
- PD** _____ **FS** _____ **Item** _____ (arrows point to each of these three fields)
- Type name _____ (arrow points to the line)
- Type code _____ (arrow points to the line)
- Form _____ Part _____ (arrows point to both lines)
- Finish _____ Vessel # _____ (arrows point to both lines)
- Count _____ Weight _____ (arrows point to both lines)
- Comments _____ (arrow points to the line)

Part: Record this as body, handle, or rim. Write the part description, not the part code, in this space.

Vessel #: This line is filled out when enough sherds refit for a direct measurement of a vessel dimension to be taken; all those sherds are bagged together. Sherds that are not from the same vessel are bagged separately and a dash should be entered on the vessel # line. Vessel numbers are assigned sequentially across the entire collection from a site.

Count and Weight: Record the total number of sherds described by this label. If the label refers to a piece to which an item number has been assigned, the count should be “1.” The weight of sherds described by the label should be recorded to the nearest tenth of a gram.

Comments: A variety of information is recorded in comments.



Universal Section

Vessel Part

There are only three options for vessel part: body, rim, and handle (Figure 6.113). Because “body” is the default option, you can record vessel part for every sherd.

Body

Body sherds include all sherds that do not preserve portions of a rim or handle (Figure 6.112).



Figure 6.112. Body sherd.

Handle

Handles include all sherds with evidence of a handle or handle attachment (Figure 6.114). If portions of both a handle and a rim are present on the same sherd, “rim” trumps “handle.”



Figure 6.114. Handle sherd.

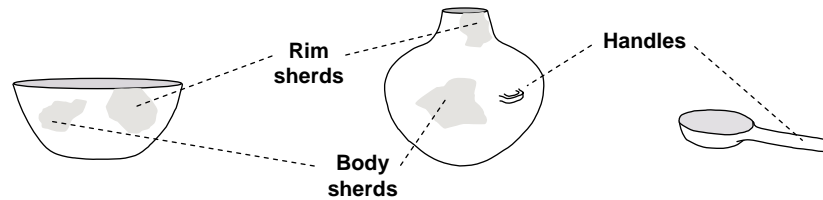

Figure 6.113. Pottery vessel parts.

Rim

Rim sherds preserve a portion of the finished lip or mouth of a vessel (Figure 6.113). The rim edge should look uniform in color whereas on a broken edge you should see a dark streak in the cross section. Be careful not to mistake use wear or a broken coil of a corrugated or neckbanded jar for a rim.

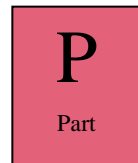

Figure 6.113. Rim sherd.

Remember: Each rim and handle sherd is given an item number and bagged individually.

SITE: 5MT123
 PD _____ FS _____ Item
 Type name _____
 Type code _____
 Form _____ Part
 Finish _____ Vessel # _____
 Count _____ Weight _____
 Comments _____

Write out “Body,” “Handle,” or “Rim” on the analysis label. Do not use the part code.



Universal Section

Slip and Polish

Remember: “Finish” for red ware sherds is determined on the basis of slip.

“Slip” refers to a thin wash of water and clay applied to the surface of a pottery vessel after it is formed. If slip is applied thickly enough, it will obscure the temper particles and scrape marks that would otherwise be visible on the surface and, once fired, will have a crazed or crackled, appearance. The slip often is a different color than the underlying paste. Figure 6.115—6.117 show examples of slipped and unslipped sherds.

“Polish” is created by rubbing a smooth stone over the surface of a vessel after it has partly dried but before it is painted. Polishing produces a smooth, lustrous finish. Polishing marks—broad and flat shiny streaks—are often visible. Polishing also obliterates scrape marks, the thin, linear scratches created when the vessel was formed. Figures 6.116 and 6.117 show examples of polished sherds.



Figure 6.115. Unslipped white ware sherd.

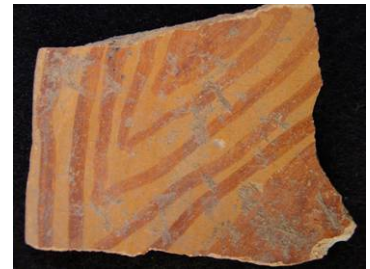

Figure 6.116. Unslipped, polished red ware sherd.



Figure 6.117. Slipped, polished red ware sherd.

If you are describing red ware sherds, write “Slipped,” “Unslipped,” or “Indeterminate” on the finish line of the analysis label. Although white ware sherds are usually slipped, we do not record the presence or absence of slip in our analysis.



SITE: 5MT123
PD _____ FS _____ Item _____
Type name _____
Type code _____
Form _____ Part _____
Finish Vessel # _____
Count _____ Weight _____
Comments _____



Universal Section

Temper and Paste (page 1 of 2): Definitions

Temper refers to aplastic material that is mixed with clay and water during the manufacturing process (Figure 6.118). Temper makes the resultant paste (see below) more flexible, it reduces shrinkage, and it protects against cracking as newly formed vessels are dried. It also makes cooking pots more resistant to thermal stress after they have been fired. The tempers used by ancient potters in Southwestern Colorado include recycled pottery sherds, crushed igneous and sedimentary rocks, and sand.

Identification of tempers can help us distinguish gray ware from white ware, early white ware from late white ware, and imported pottery from local pottery:



Figure 6.118. Temper particles are visible in this sherds cross section.

- Corrugated gray and plain gray pottery is always tempered with large fragments of crushed igneous or sedimentary rock that is visible to the naked eye.
- The temper in early white ware is often crushed rock but the temper size is much smaller than in corrugated gray ware or plain gray ware.
- Any white ware sherd with crushed-sherd temper is a late white ware. Crushed sherd temper has the same consistency as the surrounding paste, and will often be invisible to the naked eye. Any white ware sherd with crushed-sherd temper is a late white ware.
- Sparkly trachybasalt or biotite mica temper is characteristic of imported Chuskan pottery.

Paste refers to the mixture of clay, temper, and water used to make a pottery vessel. Most of the clays used in ancestral Pueblo pottery derived from sedimentary shales, and they were mined from bedrock or residual bedrock sources. The relative coarseness of pottery paste changed through time. Gray and early white ware pastes consist of coarsely ground clay and temper particles, and late white ware pastes consist of more finely ground clay and temper.

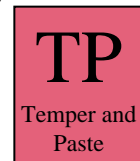

Universal Section

Temper and Paste (page 2 of 2): Definitions

Distinguishing Gray Ware Paste from White Ware Paste

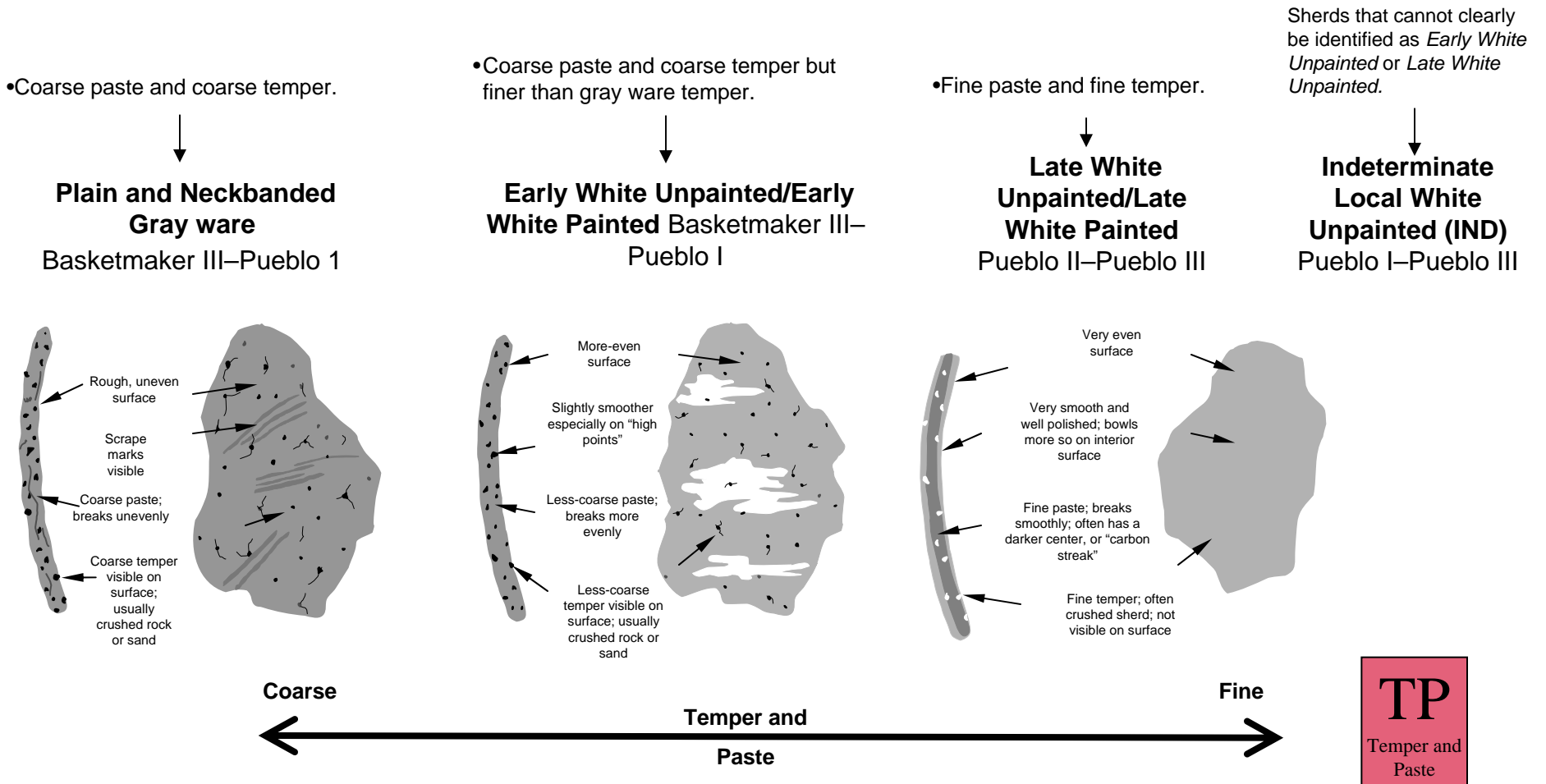

Figure 6.119. Comparison of Temper and Paste on Gray ware, Early and Late White wares.

Chapter 7

Detailed Pottery Analyses

During basic pottery analysis (see Chapter 6), we identify the ware, type, form, part, and finish of every sherd cataloged as “bulk sherds, large.” After this basic analysis has been completed and the information entered into the database (see Figure 2.1), we record additional data about a variety of pottery artifacts, including whole and reconstructed vessels, unfired sherds, modified and shaped sherds, and rim sherds from selected spatial or temporal contexts. The following analyses are conducted as standard steps in the processing of pottery assemblages from our excavations: reconstructible-vessel analysis, rim-arc analysis, and temper analysis. Each of these is described in the following pages.

Reconstructible-Vessel Analysis

In the Crow Canyon lab, the term *reconstructible vessel* refers to (1) sets of conjoining sherds that make up enough of a vessel that at least one vessel dimension can be measured, and (2) vessels that are recovered intact or nearly so. We assign a vessel number to each reconstructible vessel found in the assemblage from a site. This number is associated with the analysis records for the relevant sherds in the basic pottery analysis data table and with a record in our vessel analysis data table.

The identification of vessels begins in the field. As a site is excavated, members of the field staff note any intact vessels and/or clusters of sherds that appear to be from reconstructible vessels as they are uncovered. The “find spots” of these items are plotted on a map, and point-location numbers are assigned to the objects depicted on the map. These items are then bagged separately and labeled to alert the lab to their presence.

Members of the lab staff also look for potential reconstructible vessels when artifacts are screened and washed after being brought in from the field. The assessment of potential reconstructible vessels is based on sherd size (large sherds that give a sense of vessel dimensions), the number of sherds from the same vessel (that is, sherds that refit and/or have the same surface and stylistic treatments), and context (structure floors and formal midden deposits are contexts in which whole or partial vessels are most likely to be found).

Finally, the lab staff identify reconstructible vessels during cataloging and basic pottery analysis. During cataloging, any comments on the field bag related to reconstructible vessels are copied to the comments line of the Field Specimen (FS) Form associated with that FS and PL number. During basic pottery analysis, vessel numbers are assigned to all reconstructible vessels identified in previous processing steps, and a final check is made for additional vessels that may have been overlooked earlier.

As each vessel is recognized, a member of the lab staff assigns a unique number to that vessel. Vessel numbers are assigned sequentially as vessels are identified within a site assemblage, and

they are documented in a reconstructible-vessel log for that site. This log consists of pottery vessel analysis forms (Figure 7.1), one form per vessel, on which all information about a given vessel is recorded.

The pottery data table also links the vessel number with the pottery analysis records for the sherds that make up the vessel. After the completion of basic pottery analysis, the database can be queried for a list of all sherds from reconstructible vessels and their proveniences. Adjacent proveniences may then be searched for additional sherds that might be associated with a given vessel.

In order to collect reconstructible-vessel data, we must temporarily refit the sherds from each vessel. This task is usually performed by volunteers, staff, and/or interns (Figures 7.2-7.4). As a vessel is being reassembled, the sherds are held in place by masking tape. To ensure that we maintain provenience control during this process, an additional piece of masking tape is fixed to each sherd and labeled with the PD, FS, and item numbers for that sherd. Once the pieces of a vessel have been refit, the appropriate data are recorded on the Pottery Vessel Analysis Form and the vessel is photographed (these steps are described in detail below). After the data have been recorded and the photographs taken, all masking tape is removed and the individual sherds are placed back in their original curation bags.

Recording Reconstructible-Vessel Data

Reconstructible-vessel data reside in computer data tables that store information on vessel type, form, size, use, modification, and completeness, as well as various volumetric and dimensional measurements. The following information is recorded on the Pottery Vessel Analysis Form (Figure 7.1) and subsequently entered into the computer:

- C pottery type
- C vessel form
- C size class
- C modified-form class
- C vessel volume, weight, and dimensions (a variety of measurements are recorded)
- C handles/applications
- C modification and use wear (a variety of attributes are recorded)
- C condition and estimated portion present

In the following paragraphs we describe these variables and their attributes.

Pottery Type

This is a qualitative variable that refers to the pottery type designation appropriate to the entire vessel. Because our basic pottery analysis is sherd-based—that is, each sherd is evaluated as an individual item—the pottery types recorded for individual sherds from a single vessel often differ from one another and from the pottery type assigned to the vessel as a whole. During

vessel analysis, we record the pottery type designation appropriate to the entire vessel, regardless of the pottery type or types that may have been used to categorize its constituent sherds. Pottery types, and the process by which they are determined, are discussed in detail in Chapters 5 and 6.

Vessel Form

This is a qualitative variable that refers to the original form of the reconstructed vessel. To the extent that form follows function, many vessel forms are functional, as well as formal, categories. The list of vessel forms we specify, and their associated codes, are listed in Table 7.1.

Table 7.1. Vessel Forms	
Code	Description
BEK	beaker
BOWL	bowl
CAN	canteen
DIP	dipper
EFF	effigy
GJAR	gourd jar
JAR	jar, not further specified
KJAR	kiva jar
LAD	ladle
LID	lid
MUG	mug
OLLA	olla
OTH	other
PIT	pitcher
REC	rectangular form
SC	sherd container
SCS	sherd container, sooted
SJAR	seed jar
SUB	submarine form
UNK	unknown form
WMJAR	wide-mouth jar

Size Class

This is a qualitative variable that is applied subjectively on the basis of the analyst's knowledge of ancestral Pueblo pottery vessels. The definitions of size classes are informal and are meant only to give others a general sense of vessel size (formal size categories can be developed from the measurements we record). The list of informal size classes we use is given in Table 7.2.

Table 7.2. Size Class	
Code	Description
LG	large
MED	medium
MIN	miniature
SM	small

Modified-Form Class

Modified-form class is recorded for still-usable containers that were created when portions of their parent vessels were removed through chipping and/or grinding, resulting in a change in form and probably use. Modified vessels most often were created after their parent vessels broke or were no longer usable for their original intended functions. We often refer to modified vessels derived from broken vessels as “sherd containers.” Because there is no defined list of options for this variable, entries in this field consist of descriptive labels (for example, “*puki*” and “sherd plate.”)

Vessel Volume, Weight, and Dimensions

A variety of data pertinent to a vessel’s size and shape are recorded. See Figure 7.5 for illustrations of specific vessel dimensions. Some measurements are not applicable for certain vessel forms, and many measurements cannot be obtained for partial reconstructible vessels. The tools used to obtain these vessel measurements include, but are not limited to, calipers, tape measures (with millimeter increments), osteometric boards, bird seed and graduated cylinders (for volume), and a digital scale (for weight). Dimensions are recorded in millimeters (mm), volumes are recorded in milliliters (ml), and weights are recorded in grams (g). Brief instructions for how to record each measurement are given below.

Maximum Diameter: Record the largest diameter on the exterior surface of the vessel.

Maximum Diameter Height: Measure the height above the base where the maximum diameter measurement was taken.

Orifice Diameter: On a jar, measure the inside of the narrowest point on the neck. On a bowl, measure the interior rim edge.

Orifice Diameter Height: On a jar, record the height above the base where the orifice diameter measurement was taken. On a bowl, the orifice diameter height is identical to the rim height.

Rim Diameter: On a bowl, measure the diameter of the outside lip of the vessel rim. On a bowl, rim diameter is identical to the maximum diameter.

Rim Height: Measure the total height from the base to the rim.

Rim Thickness: Record the average thickness of the rim.

Body Wall Thickness: This may be obtained by measuring the thickness of individual sherds that make up a reconstructible vessel. Note if the measurement is an average.

Effective Volume: Use bird seed to determine volume. Fill the vessel to the rim of a bowl and to the inflection point of a jar, and then measure the volume by pouring the bird seed into graduated cylinders.

Total volume: Use bird seed to determine volume. Fill the vessel to the rim and then measure the volume using graduated cylinders.

Sherd Container Volume: Follow the same procedure as above for effective volume.

Sherd Container Diameter: Measure the maximum width of the vessel in the same way that rim diameter is measured.

Weight: Record the weight of the reconstructed vessel; also note the weight of the unreconstructed portion.

Certain measurements were recorded in the past but are not part of our current analysis. Because some data for these discontinued measurements are present in our database, they are described here using small type.

Inflection Point Diameter: This measurement is usually the same as the orifice diameter (depending on the vessel form), but is measured from the outside of the vessel.

Inflection Point Height: This measurement is taken from the base to the inflection point on the outside of the vessel.

Condition

Two variables are used to record vessel condition. The “Completeness” of the vessel as encountered in the collection is described using the categories in Table 7.7; and the “estimated portion present” is estimated to the nearest 5% when the sherds from a vessel are reconstructed. Both measures are entered in the appropriate spaces on the Pottery Vessel Analysis Form.

Table 7.3. Completeness	
Code	Description
CRV	complete, reconstructible
CUV	complete, unbroken
NCV	nearly complete
ORS	other refitted sherds
PV	partial

Handles/Applications

These attributes document the type and placement of handles or applications. Tables 7.4 and 7.5 describe the handle types, handle locations, and the database codes for these attributes.

Table 7.4. Handle Type	
Code	Description
AF	animal form
AS	application scar
CF	coil form
LH	lug handle
OH	other handle
SF	spiral form

Table 7.5. Handle Location	
Code	Description
BA	base
BO	body
H	handle
I	interior
L	lip
N	neck
O	other
R	rim
S	shoulder

Modification/Use-wear

Modification and use-wear are modifications to a vessel that do not affect its original form and presumed function. Several attributes document these modifications, including: use wear type, location, coverage, and degree of expression. Use-wear type codes and descriptions are given in

Table 7.6. Use-wear location is described using the codes in Table 7.7, and/or the handle location codes (Table 7.5). Coverage is a percentage estimate of the vessel surface area that is covered by a given type of use wear. Finally, degree of expression is a qualitative attribute that records whether the modification is slight, moderate, or heavy.

Table 7.6. Use Wear Type	
Code	Description
A	abrasion
S	sooting
ST	striations

Table 7.7. Use-Wear Location	
Code	Description
E	exterior
H	handle
I	interior
L	lip
N	neck
R	rim

Other Data Recorded with Reconstructible Vessels

The Pottery Vessel Analysis Form also includes a large space for written description and notes. Although the analyst may exercise some discretion in what he or she deems noteworthy, **the following information is required** in the “Description/Explanation” section of the form:

- Provenience information: Record the study unit type(s) and number(s) (for example, Structure 101, Nonstructure 211, Arbitrary Unit 302), as well as the PD, FS, and PL numbers for sherds associated with each vessel. This information helps the lab staff manage the collections and data.
- Sherd analysis data: Record general descriptive data about the sherds that make up the vessel (for example, 11 bowl bodies and three bowl rims).
- Photograph numbers: Photographs are almost always helpful in documenting reconstructed vessels. If photos are taken, the roll and frame numbers should be recorded in the vessel description section.
- Vessel illustration: Sketch the vessel, as reconstructed, on a separate sheet of paper. Label the sheet with the site number and vessel number and attach it to the Pottery Vessel

Analysis Form for that vessel.

- Location: Note the location of the sherds or vessel (for example, “stored in bulk sherds,” or “on display in curation room”).

Photographing Reconstructible Vessels

Photography is an important part of the documentation process for reconstructible vessels. In addition to supplementing descriptive information on the Pottery Vessel Analysis Form, photos are used in Crow Canyon’s publications, including on-line databases. We currently photograph reconstructible vessels on color slide film to ensure safe archiving of the images; however, it is likely that we will incorporate digital photography into our procedures in the future.

Photographs of reconstructible vessels are taken in the lab. Once a vessel is reconstructed and analyzed, it is prepared for photography. This generally requires removing as much masking tape as possible without compromising provenience control or the stability of the vessel. An appropriate background is selected, usually a black or gray felt. Metric scales are used in all cases unless a particular detail shot of a vessel is desired.

A 35-mm camera, mounted on a tripod, is used to shoot the photos. If artificial light is used, the light from two to three incandescent lights is bounced off white walls or a foam-core background surrounding the subject to provide indirect lighting. We also use indirect natural light coming through a window when possible. Using a cable release, a low-speed setting (usually no less than ½ second), and a low-speed slide film, we can produce a high-quality slide image of the artifact. One or more photographs from different angles may be taken to show the vessel’s form and design elements.

Detailed Rim-Sherd Analysis

We normally collect data on a variety of attributes on samples of rim sherds after completing basic pottery analysis of the entire sherd collection. We conduct detailed analysis only on samples of rim sherds in a collection for several reasons. First, we focus on rim sherds because they preserve more attributes of their parent vessels than is the case for body sherds, and it is often possible for us to control for those sherds that derive from the same vessel using rim sherds. As a result, detailed analysis data can be conceived of as representing vessel attributes as opposed to sherd attributes. Second, it is time-consuming to collect such data, and it requires substantial training beyond that which can be accomplished in the context of our public education programs. As a result only staff and interns are normally capable of collecting such data consistently and accurately. Finally, detailed analysis data are most germane to specific research questions that are most easily answered using material from tightly controlled spatial and temporal contexts. Thus, collecting detailed analysis data for rim sherds from all contexts would involve significant unproductive time and expense.

The selection of rim-sherd samples for detailed analysis varies from project to project based on

our research design and the nature of the contexts encountered during field work. Currently, we collect detailed analysis data from samples of rims from gray ware jars (including plain and corrugated jars) and white ware bowls from well-dated midden contexts. However, additional vessel forms and contexts have been analyzed in the past for specific purposes (see, for example, Pierce et al. 1999*2). In addition, we normally select a subset of rims that are large enough (as judged by their weights recorded during pottery analysis) to allow us to accurately record the attributes we are interested in. Our experience is that rim sherds weighing less than 2 g are almost always too small for detailed analysis.

We typically collect data on a variety of attributes of rim sherds, including rim-arc measurements, temper and paste characteristics, design attributes, and rim form attributes. Because the specific attributes studied varies from project to project, and varies across wares and forms, we do not maintain a standard form that we use every time we conduct rim-sherd analysis. Rather, we design a form for the specific data we wish to record for a given collection for each type of rim analyzed (corrugated jar, white ware bowl, etc.). We have found that it is most efficient to first determine the full suite of attributes we wish to record for a single sample of rim sherds, and then to create the forms and database tables necessary so we can record all the attributes we are interested in at once during detailed pottery analysis.

Once the sample of rim sherds to be analyzed is chosen, an inventory is created using a query of the basic pottery analysis data. This inventory lists the PD, FS, and Item Numbers, as well as the basic pottery analysis data for each artifact. As each sherd is analyzed, it is checked off the inventory list. If any corrections to the original pottery analysis data are warranted, they should be written on the inventory and the changes made in the database at the conclusion of analysis. Each analyzed sherd is identified on the recording sheet using its catalog information (Site, PD, FS, and Item numbers) on the inventory list and on the analysis label associated with the sherd. This ensures that any future data collected from that sherd can be linked to the detailed analysis results.

Although the complete list of attributes examined in detailed rim-sherd analysis varies from project to project, we collect rim-arc and temper data as standard procedure during detailed pottery analysis. We therefore describe the methods we use in collecting these data in the following paragraphs. For details on additional design and form attributes collected during various projects, see the “Artifacts” chapters for various projects available on Crow Canyon’s web site.

Rim-Arc Analysis

Rim-arc analysis is a method of estimating the proportion of a vessel circumference represented by a rim sherd, and the rim diameter of the original vessel, based on the length and curvature of a rim sherd from that vessel. Such data yield important information about vessel sizes, relative numbers, and details of vessel shapes. For a discussion on the interpretation of rim-arc data, the reader is referred to Pierce and others (1999*2). The way we take rim-radius and degree-of-arc measurements is described below:

Radius: Place the rim surface in the center of the rim-arc template in proper orientation (as though it were sitting upside down in a complete vessel) and slide the sherd outward until the best fit is found between the outside edge of the rim and one of the nested circles on the template (Figure 7.7). The template circles are in centimeter intervals. Record the radius estimate to the nearest centimeter.

Degrees of Arc: Once the radius estimate has been determined, the degrees of arc represented by that rim segment can be estimated by determining the slice of a 360 degree pie represented by that rim. This should be done to the nearest 5 degrees using the guides on the rim-arc template.

When too little of the rim is present for a specific measurement, a line should be drawn through the relevant space to indicate that no measurement could be made. A note should also be added in comments stating why no information was recorded.

Temper Analysis

Temper refers to the aplastic inclusions that are mixed with raw clay during pottery manufacture. These materials make clay pastes more flexible, less likely to crack during drying and firing, and more resistant to the stresses of thermal expansion. Certain tempering agents preferred by potters in specific times and places are found only in certain locations on the landscape. As a result, sherds containing these tempers either were made close to sources of these tempers or were made using imported raw materials. Patterns in the distribution of sherds with specific tempers vis-a-vis their natural distributions thus provide evidence of exchange and social interaction networks. The following paragraphs describe the methods we use in collecting temper data.

Analysts examine the cross-section of a fresh break on each analyzed sherd using a binocular microscope (Figure 7.9). The fresh break is made by using pliers to remove a nip from each sherd in a manner that is the least likely to impair our ability to extract other kinds of information from the sherd (for example, rim length, rim form, or painted design). The attributes recorded include paste color, temper type, abundance, size, and the relative frequency of a particular temper type in relation to other types found within the same sherd. In addition, the Munsell Color Chart is used to record the color of the paste and carbon streak of the sherd. These attributes and their documentation methods are described below.

Temper Type: The categories we use are essentially based on the direct observations of the analyst. To minimize interobserver variation, we have developed a temper identification guide that include photomicrographs of materials we encounter most frequently (Lyle and Tucholke 2003*1). Currently, 13 temper types are recognized and documented in Crow Canyon's database. These types, and their associated codes, are given in Table 7.9.

Table 7.9. Temper Types		
Number	Code	Description
0	I	indeterminate

1	CS	crushed sandstone
2	QS	quartz sand
3	IR	igneous rock
4	SH	crushed pottery sherds
5	TB	trachyte
6	PS	pink-cemented sandstone
7	O	other
8	MX	mixed
9	LI	multilithic sand
10	SL	shale
11	MR	crushed metamorphic rock
12	WS	weathered silicified sandstone
13	CQ	crushed quartz

Temper Type Frequency: The relative frequency of temper types observed within the cross section of a single sherd is indicated by recording up to three temper types in decreasing order of their observed abundance.

Temper Abundance: The abundance of all tempers considered together is recorded using a geotechnical gauge (Figure 7.10), which illustrates the density of particles corresponding to a particular percent abundance. The categories illustrated on the gauge are: 3%, 5%, 15%, 25%, 40%, and 50%. These are the six categories recorded by analysts. If the abundance cannot be determined, no data are entered.

Particle Size: The size of temper particles is documented using a grain-sizing folder (Figure 7.11), which illustrates ranges of measurable grain sizes. We record one or more of the four grain size options listed in Table 7.10, below. If particle size cannot be reasonably determined, no data are recorded.

Range (mm)	Code	Description
1/8–1/4	F	Fine
1/4–1/2	M	Medium
1/2–1.0	C	Coarse
1.0–2.0	VC	Very Coarse

Paste Color: We record the color of the unrefired paste and the carbon streak, if present, as a standard part of temper analysis. These observations are made using indirect incandescent light on a fresh break by comparing the observed color to the color chips on the Munsell Color Chart.



Figure 7.2. Reconstructing a jar.



Figure 7.3. Refitting sherds with masking tape.



Figure 7.4. Labeling the masking tape on refitted sherds with provenience information.

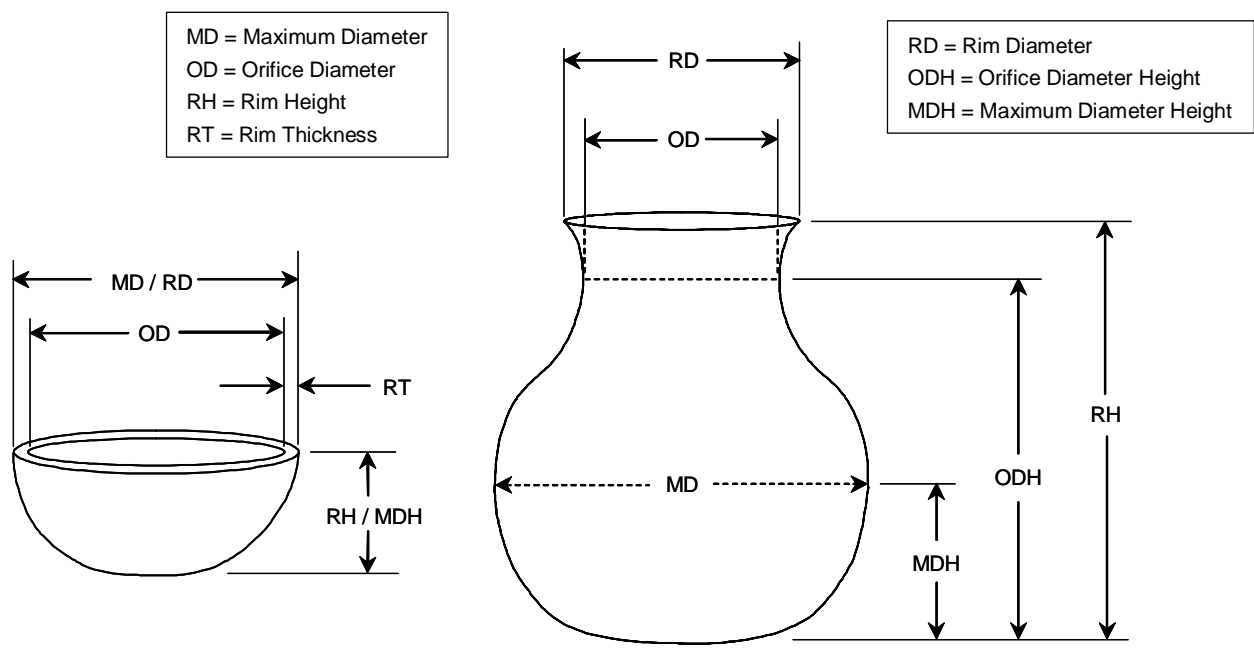

Figure 7.5. Vessel Measurements

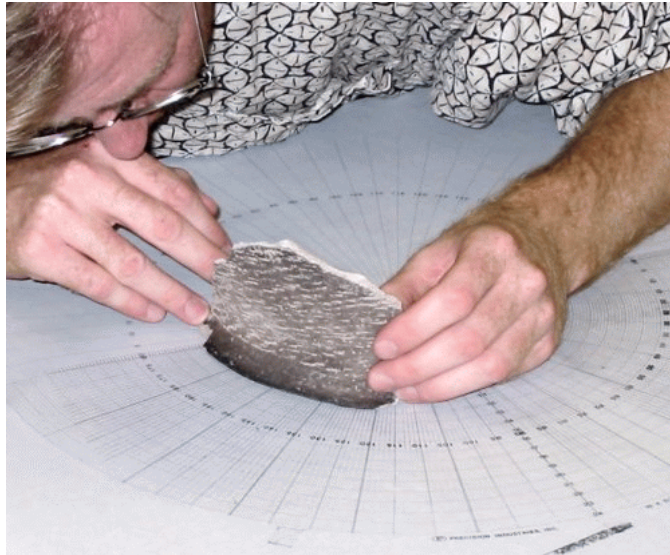

Figure 7.6. Measuring the rim radius and degrees of arc of a corrugated jar rim sherd.



Figure 7.7. Identifying temper using the binocular microscope.

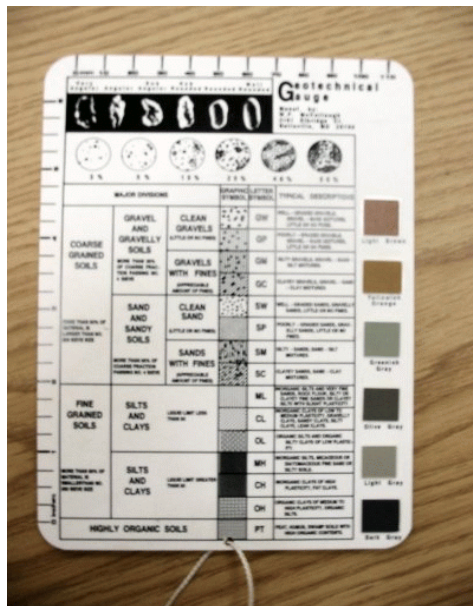

Figure 7.8. A geotechnical gauge. The abundance scale is located in the second row from the top.

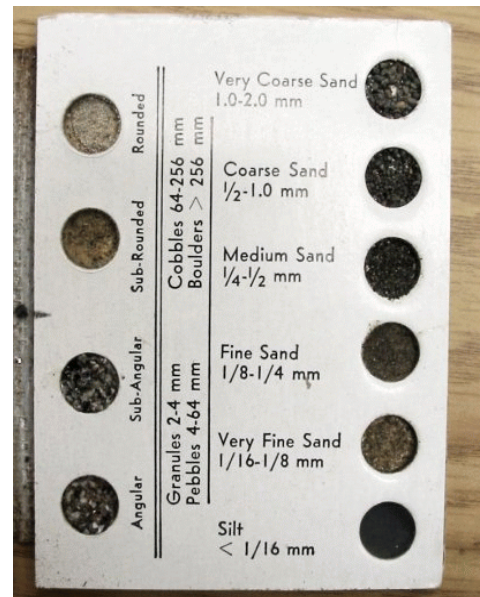

Figure 7.9. Grain-sizing folder.

Chapter 8

Stone Material Identification

Identification of the materials used for chipped-stone tools, ground-stone tools, and stone ornaments is an important part artifact analysis. Raw materials for tools and ornaments were obtained either directly from natural sources or through trade. By studying the sources of raw materials vis-à-vis the sites where artifacts of these materials are recovered, we gain valuable insight into interaction networks and the organization of stone-artifact production. In this chapter, we provide detailed descriptions of the various stone materials observed in assemblages from sites excavated by Crow Canyon. We use these descriptions during both cataloging (Chapter 3) and bulk chipped stone analysis (Chapter 9) to identify the materials from which artifacts were made. Our descriptions of local material types rely heavily on the work of Gerhardt (2001*1).

This chapter is organized in such a way that identification proceeds from the most common stone materials to the least common materials. An overview of stone materials codes is given on page 8-2. Pages 8-3 and 8-4 explain how to distinguish the most common stone materials from the Morrison Formation. Then, pages 8-5 through 8-8 provide detailed descriptions of each Morrison Formation material we recognize. These descriptions include: 1) information on the physical attributes of each material, such as grain size, texture, color, opacity (ability to transmit light) and luster (ability to reflect light); 2) a listing of the artifact categories in which the given material is most often represented; 3) a photograph of one or more specimens of the material; 4) how and when each material was formed in geologic time; and 5) an explanation of the three-letter code we use to record the material type during cataloging and bulk chipped-stone analysis.

Page 8-9 organizes the other stone materials we recognize according to the grain size and relative abundance of each in artifact assemblages from archaeological sites in southwestern Colorado. Pages 8-10 through 8-21 provide detailed descriptions for the most common of these materials using the same format as that described above for Morrison Formation materials. Finally, pages 8-22 and 8-23 provide descriptions of various rare stone materials, and the categories we use for unknown and indeterminate stone materials. Identification of specimens of these material types will always require the assistance of a staff member.

Stone Material Identification

Overview of stone material codes

The stone material codes below match those found on the back of the FS coding sheet (Chapter 3). The material name is on the left and the corresponding code is in capital letters on the right. Over the past few years many of the stone materials we identify have been reinterpreted in geological terms. Old codes for these categories, which are no longer in use but are reflected in our database, are listed next to the current category name in parentheses and using small type.

STONE MATERIAL CODES		
<u>Local Stone Materials</u>	<u>Nonlocal Stone Materials</u>	<u>Other Stone material types</u>
Dakota/Burro Canyon silicified sandstone (DQT) KDB	jet JET	agate/chalcedony ACH
Burro Canyon chert (BUR) KBC	obsidian OBS	caliche CAL
Morrison mudstone (MCS) KJM	red jasper RJS	conglomerate COG
Morrison chert (MCS) KJC	turquoise TUR	concretion CON
Morrison silicified sandstone (MQT) JMS	Washington Pass chert WPC	gypsum/calcite/ barite GCB
Brushy Basin chert (BBC) JMC	nonlocal chert/ silt stone NCS	igneous OIG
Sandstone SND		petrified wood PET
		quartz QTZ
		slate/shale SLS
		unknown chert/siltstone UCS
		unknown silicified sandstone (UQT) USS
		unknown stone UNS

Notes:
 1. K = cretaceous geologic period, J = Jurassic geologic period.
 2. Relationships between obsolete codes and current categories are shown using parentheses and small type).

Step 1: Distinguish Morrison formation materials from all others

If you are trying to identify the material of an individual artifact, determine which of these two categories the material falls into. If you are identifying materials in bulk chipped-stone, separate the artifacts into two piles:

Morrison Formation materials (Figure 8.1, left) are always opaque (no light can be seen through the edges of the object), and have muted colors ranging from green and maroon to brown, tan, and light gray. Morrison formation materials most often have a consistent color, but can also be spotted or banded. Only the finest Morrison formation materials are reflective; most have a dull, matte appearance. Most of the chipped-stone artifacts we recover from our excavations are made from Morrison formation materials. These materials will be subdivided further in Step 2.

Other materials (Figure 8.1, right) include all stones that do not fit the description above. These materials are described on pages 8-9 through 8-23, and include sandstone, conglomerate, slate, shale, agate, chalcedony, jasper, obsidian, petrified wood, a variety of cherts, silicified sandstones, and minerals. These materials will be subdivided further in Step 3.



Figure 8.1 (Left). A bag of chipped stone divided into Morrison formation materials on the right, and other materials on the left.

Step 2: Identify specific Morrison formation materials

Specific Morrison formation materials are distinguished on the basis of grain size and the proportion of material that is silica. Coarse materials consist primarily of grains cemented together with silica, whereas fine materials consist primarily or exclusively of silica. The four varieties of Morrison formation material are arranged along this continuum below. See the specific description of each material for more details.

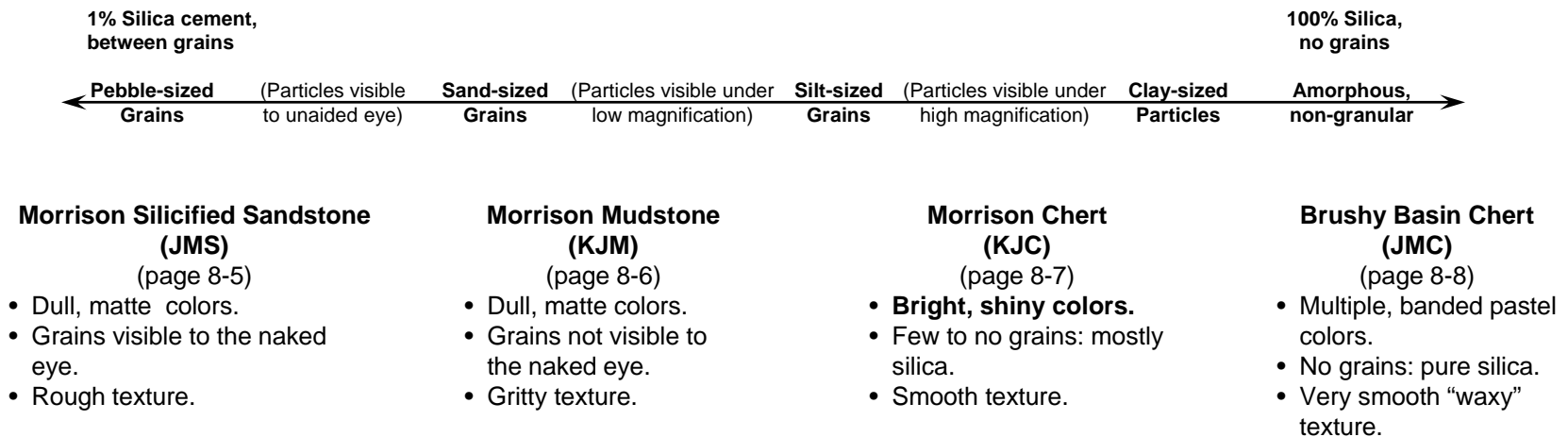

Figure 8.2 (Left). Morrison formation materials grouped by material type; from left to right: Morrison Silicified Sandstone, Morrison Mudstone, Morrison Chert, and Brushy Basin Chert.

After you have identified all Morrison formation materials, go on to Step 3 (Page 8-9) to identify all other materials.

Morrison Silicified Sandstone (JMS)

Morrison silicified sandstone is a coarse-grained, multicolored, silicified sedimentary rock (Figure 8.3). Because it is locally abundant and durable, it was used extensively for a variety of tools.

Morrison Silicified Sandstone (JMS)	
Color	varying shades of maroon, green, tan, and brown; colors are often mottled
Opacity	always opaque
Grain size	varies from large- to medium-sized grains that may require low magnification to be seen
Texture/hardness	usually rough to the touch
Appearance	always dull; large-grained specimens are visibly rough; medium-grained specimens will look smoother
Characteristic features	hard and tough material, difficult to flake precisely



Figure 8.3. Morrison silicified sandstone. Note the mottled colors; close-up views show a rougher sample on the left and a somewhat smoother sample on the right.

Artifact Types	Geological Formation/ Origins	Code Description
Debitage is the most common; also a preferred material for stone axes, peckingstones, cores, and flake tools; projectile points and drills are not common	From the Brushy Basin Member of the Morrison Formation. The sedimentary sands were deposited in a still-water setting and later cemented together with silica	J = Jurassic period M = Morrison Formation S = Silica-cemented sandstone

Morrison Mudstone (KJM)

Morrison mudstone is a multicolored silicified sedimentary rock composed of fine silts and/or silicified volcanic ash (Figure 8.4). Its colors are similar to those seen in Morrison silicified sandstone, but it has a smoother texture. It is widely available in the local Morrison and Burro Canyon formations and was used for a variety of chipped-stone tools.

Morrison Mudstone (KJM)	
Color	varies from light to dark shades of gray, tan, brown, maroon, and green; colors are often mottled
Opacity	always opaque
Grain size	medium to fine (visible with a hand lens)
Texture/hardness	moderately smooth, may feel gritty
Appearance	dull, nonreflective
Characteristic features	diversity of colors, including mottled combinations of light and dark colors



Figure 8.4. Morrison mudstone. Note the variety of colors.

Artifact Types	Geological Formation/ Origins	Code Description
Debitage, peckingstones, and cores are common; bifaces, projectile points, drills, and axes are less common	These mudstones are from the Burro Canyon Formation and the Brushy Basin Member of the Morrison Formation. They are fine-grained and composed of silicified silt and volcanic ash that were originally deposited in a lake environment	K = Cretaceous period J = Jurassic period M = Mudstone

Morrison Chert (KJC)

Morrison chert is a local, multicolored, very finegrained, silicified sedimentary rock that has excellent flaking qualities and was commonly used for a variety of chipped-stone tools (Figure 8.5). It occurs in a variety of colors.

Morrison Chert (KJC)	
Color	varying shades of maroon, green, tan, and brown; colors are often mottled.
Opacity	always opaque
Grain size	very fine; high magnification is required to see occasional small grains
Texture/hardness	very smooth, although flaws frequently occur in the rock which make it rough or difficult to flake
Appearance	bright, shiny surface
Characteristic features	variation in grain-size and silica content within the material



Figure 8.5. Morrison chert. Note the smooth texture, shiny surface, and mottled colors.

Artifact Types	Geological Formation/ Origins	Code Description
Mostly chipped-stone tools (cores, flake tools, bifaces, projectile points, and drills); also fairly common in debitage	Morrison chert is a fine-grained chert found in the Burro Canyon Formation and the Brushy Basin Member of the Morrison Formation. It is derived from volcanic ash deposited in shallow lake environments.	K = Cretaceous period J = Jurassic period C = Chert

Brushy Basin Chert (JMC)

This extremely finegrained, multicolored, silicified sedimentary rock is found in the Brushy Basin Member of the Morrison Formation along the Utah—Colorado border (Figure 8.6). It is one of the finest materials in the region and was used for making chipped- and polished-stone artifacts.

Brushy Basin Chert (JMC)	
Color	White and pastel shades of tan, pink, green, and orange, combined with darker shades of brown, reddish brown and gray; combinations of three or more colors in swirled or banded (layered) patterns are common
Opacity	always opaque
Grain size	nongranular; all grains have been replaced by silica
Texture/hardness	very smooth and waxy
Appearance	usually shiny; polished artifacts have a very high luster
Characteristic features	banded or swirled colors; subtle pastels are common



Figure 8.6. Brushy Basin chert. Note the subtle banded colors.

Artifact Types	Geological Formation/ Origins	Code Description
Chipped- and polished-stone artifacts (cores, debitage, bifaces, projectile points, tchamahias and pendants) (See Chapter 4)	Found in the Brushy Basin Member of the Morrison Formation; it derives from very fine-grained volcanic ash that was deposited in a shallow lake environment	J = Jurassic Period M = Morrison Formation (Brushy Basin Member) C = Chert

Conglomerate (COG)

Conglomerate is a very coarsegrained, sedimentary rock that is found locally in the Dakota Sandstone and Burro Canyon Formations (Figure 8.7). It consists primarily of silica-cemented waterworn pebbles that are visible to the naked eye. This material was used primarily for manos and metates.

Conglomerate (COG)	
Color	usually light tan to light yellowish brown matrix surrounding sand grains and pebbles of different colors
Opacity	always opaque
Grain Size	very coarse; sand grains and small pebbles easily visible to the unaided eye
Texture/hardness	bumpy; rough silica cement combined with waterworn pebbles; can be friable
Appearance	dull
Characteristic features	multi-colored waterworn pebbles



Figure 8.7. Conglomerate.

Artifact Types	Geological Formation/ Origins	Code Description
Primarily manos and metates	Sedimentary gravels at the interface of the Dakota and Burro Canyon Formations; derived from fine gravels deposited in a riverine or delta setting.	COG = Three-letter abbreviation for conglomerate

Sandstone (SND)

Sandstone is a dull, grainy rock that consists of sand grains held together in a matrix of silica (Figure 8.8). It is common throughout all local geologic formations. Sandstone is a relatively friable material that is easily ground, pecked, or broken because it has undergone less silicification than other sedimentary rocks. It was a preferred material for manos, metates, and other ground-stone tools, as well as for building stone.

Sandstone (SND)	
Color	yellowish to reddish tans grading into yellowish to reddish browns; sand grains are multicolored and distinguishable from the surrounding matrix
Opacity	always opaque
Grain size	grains are visible to the unaided eye
Texture/hardness	rough and friable, like sandpaper
Appearance	always dull; can be thin and tabular, blocky, or irregularly-shaped; edges are often slightly rounded because the softness of the stone promotes wear and erosion
Characteristic features	multicolored sand grains and friability



Figure 8.8. Sandstone.

Artifact Types	Geological Formation/ Origins	Code Description
Mostly manos, metates, and other ground-stone tools; also the primary building stone	Dakota Sandstone and Burro Canyon Formation sandstones derive from aeolian sand dunes in a shoreline setting	SND = Three-letter abbreviation for sandstone

Other Igneous (OIG)

“Other Igneous” refers to rocks that derive from lavas and magmas produced during volcanic activity and that are “other” than obsidian (Figure 8.9). They are usually light to dark gray in color and nongranular, but they do contain a variety of crystalline inclusions. Igneous rocks outcrop in intrusive mountains of the Mesa Verde region, and weathered igneous cobbles can be found along watercourses that drain these mountains. Igneous rock was used as temper in pottery, and cobbles were used for ground-stone tools, hammerstones, and other battered/polished tools.

Other Igneous (OIG)	
Color	mostly shades of gray, with multicolored crystalline inclusions
Opacity	always opaque although the crystals within the matrix can be translucent
Grain Size	nongranular, but crystalline inclusions are visible to the unaided eye
Texture/hardness	rough, varies from very hard and tough to friable
Appearance	dull except for the shiny inclusions
Characteristic features	rough texture and small crystalline inclusions



Figure 8.9. Examples of “other igneous” rock.

Artifact Types	Geological Formation/ Origins	Code Description
Crushed and used as temper in pottery; cobbles were also used for hammerstones, manos, and other battered/polished artifacts	Produced as magma or lava during volcanic activity; crystals form during the cooling process; closest sources are the Ute and La Plata mountains, Dolores and Mancos rivers, and McElmo Creek	OIG = Three-letter abbreviation for “other igneous”

Slate/Shale (SLS)

Shale is a medium- to fine-grained, tabular, sedimentary rock. Slate is metamorphosed shale, which means that it has been altered by intense heat and pressure (Figure 8.10). Both types of rock can vary from light to dark gray, but slate is usually a darker gray than its corresponding shale. Slate is rare in local geologic contexts. Shale was used for beads and pendants, and it was ground and mixed with water to make potting clay. Slate was used for tchamahias, stone disks, beads and pendants, and occasionally as chipped stone.

Slate/Shale (SLS)	
Color	light gray to dark gray, shale usually being darker
Opacity	always opaque
Grain size	medium- to fine-grained, contains silt and clay particles
Texture/hardness	both are smooth; slate is hard enough to be polished, shale is highly friable
Appearance	very dull
Characteristic features	tabular structure and dull gray color



Figure 8.10. Flake of slate. Shale would not flake as well due to its softness

Artifact Types	Geological Formation/ Origins	Code Description
Both were used for jewelry (beads and pendants), shale was used for potting clay, and slate was used for tchamahias, stone disks, and some chipped-stone tools.	The Dakota and Mancos Formations are the most common sources for shale. Slate can be found in these same locations, but only where volcanic activity has occurred in the past.	SLS = Three-letter abbreviation for Slate/Shale.

Dakota/Burro Canyon Silicified Sandstone (KDB)

This material type refers to medium-grained silicified sedimentary rock that is found locally in the Dakota Sandstone and the Burro Canyon Formation. It is not possible for us to distinguish stones from these two formations, but both are characterized by a distinct glistening appearance, often described as “sugary” (Figure 8.11). This material type was used for chipped- and ground-stone tools.

Dakota/Burro Canyon Silicified Sandstone (KDB)	
Color	tan, white, light gray, sometimes blending to medium gray
Opacity	can be opaque or slightly translucent, but seldom both
Grain size	medium (visible with a hand lens); many sand grains have been dissolved and replaced by microcrystalline quartz
Texture/hardness	variable texture; always hard and tough
Appearance	sugary surfaces that are slightly rough and uneven
Characteristic features	sugarlike microcrystalline quartz dispersed throughout the stone



Figure 8.11. Dakota/Burro Canyon silicified sandstone is best identified by “sugarlike” sparkles.

Artifact Types	Geological Formation/ Origins	Code Description
Debitage, cores, modified cores, peckingstones, bifaces, projectile points, drills, and manos	From the Dakota Sandstone and the Burro Canyon Formation. This material derives from sand dunes deposited in fluvial environments, where the grains were first cemented by silica, followed by replacement of sand grains by microcrystalline quartz	K = Cretaceous period D = Dakota Sandstone B = Burro Canyon Formation

Porter Mudstone (PMS)

Porter mudstone is a reddish brown, very soft, medium-grained sedimentary rock that was first identified in the assemblage from Albert Porter Pueblo (5MT123) (Figure 8.12). It has a chalklike texture and softness. Most material appears flaked, but some pieces show small areas of grinding and other forms of edge damage.

Porter Mudstone (PMS)	
Color	terra cotta, rust, reddish brown, brown, and occasionally yellowish brown
Opacity	always opaque
Grain size	medium- to fine-grained
Texture/hardness	chalklike, as evidenced by the wear present on most edges and ridges
Appearance	very dull and non-reflective
Characteristic features	reddish-brown color and soft, chalklike texture, which is evidenced by the worn edges and ridges



Figure 8.12. Porter mudstone.

Artifact Types	Geological Formation/ Origins	Code Description
Although relatively soft, this material is commonly seen as debitage, modified flakes, and cores in the Albert Porter Pueblo assemblage	This material probably outcrops close to Albert Porter Pueblo, but its geological source and formation process are currently unknown	PMS = Three-letter abbreviation for Porter mudstone

Burro Canyon Chert (KBC)

This material type is a local, multicolored, very finegrained, silicified sedimentary rock from the Burro Canyon Formation (Figure 8.13). It has excellent flaking qualities and was used for a variety of chipped-stone tools. Burro Canyon chert is characterized by small, opal-like, chalcedony “blebs,” or inclusions, within its matrix.

Burro Canyon Chert (KBC)	
Color	shades of light tan to medium brown, light to medium green, and light to medium gray; chalcedony blebs are usually white or light gray
Opacity	tans, browns, and grays are often transparent; greens are usually opaque; chalcedony blebs are of varying degrees of translucence
Grain size	very fine; remnant sand grains are present, but most have been replaced by microcrystalline quartz
Texture/hardness	very smooth and hard
Appearance	moderate to very shiny
Characteristic features	small chalcedony nodules (blebs) throughout



Artifact Types	Geological Formation/ Origins	Code Description
Debitage, cores, drills, bifaces, and projectile points	From the Burro Canyon Formation. Stones of this type form through progressive replacement of sandstone by precipitates of silica; remnant sand grains are present	K = Cretaceous period B = Burro Canyon Formation C = Chert

Figure 8.13. Burro Canyon chert. The top photograph shows the variety of colors; the lower close-up shows chalcedony blebs.

Red Jasper (RJS)

Red jasper is a very finegrained, opaque, reddish chert (Figure 8.14). Its nearest sources are in the redrock formations of southeastern Utah, and thus is considered to be nonlocal when found at sites in southwestern Colorado. It has excellent flaking qualities and was used for a variety of chipped-stone artifacts.

Red Jasper (RJS)	
Color	varying shades of medium to dark red and brownish red; occasionally combined with brown, yellow-brown, and yellow streaks
Opacity	always opaque
Grain size	amorphous, nongranular
Texture/hardness	very smooth and somewhat brittle
Appearance	shiny, but not glassy
Characteristic features	rich shades of red and consistent opacity



Figure 8.14. Red jasper.

Artifact Types	Geological Formation/ Origins	Code Description
Because this material was imported to southwestern Colorado, it occurs most often as projectile points	A fine-grained chert found in the red shale interbeds of the Permian and Triassic sandstones that outcrop west of Comb Ridge in southeastern Utah. Stones of this type form through replacement of limestone by precipitates of silica	RJS = Three-letter abbreviation for red jasper

Petrified Wood (PET)

Cherts classified as petrified wood are varicolored, fossilized remains of trees that were buried in floodplain muds (Figure 8.15). These cherts often exhibit the structure of the wood itself, and thus have a striated appearance (Figure 8.15). Petrified wood may be found associated with the shales and conglomerate sandstones of any of the local Triassic, Jurassic, and Cretaceous formations.

Petrified Wood (PET)	
Color	combinations of dark gray, brown, and green, sometimes with small flecks of red. White or light gray chalcedony nodules or blebs may be present
Opacity	translucent browns and grays, opaque greens; chalcedony blebs are of varying degrees of translucence
Grain size	very fine, nongranular but structured
Texture/hardness	very hard, texture varies from smooth to the texture of wood grain
Appearance	very shiny
Characteristic features	striated, linear structure resembling wood grain; ring patterns may be discernible if the piece contains some cross section of a petrified log



Figure 8.15. Petrified wood.

Artifact Types	Geological Formation/ Origins	Code Description
Chipped-stone artifacts such as debitage, cores, bifaces, and projectile points	Formed by precipitates of silica replacing the organic matter in ancient trees. Often found in uranium-rich conglomerate sandstones of Triassic, Jurassic, and Cretaceous formations	PET = three-letter abbreviation for petrified wood

Agate/Chalcedony (ACH)

Chalcedony is a white or off-white, translucent, fine-grained material that formed as a precipitate of silica (Figure 8.16). Nodules are found locally in the Burro Canyon Formation. It was commonly used for projectile points and other chipped-stone tools.

Agate/Chalcedony (ACH)	
Color	white to off-white
Opacity	translucent to almost transparent on thin edges
Grain size	amorphous, nongranular
Texture/hardness	very smooth
Appearance	shiny with a high luster
Characteristic features	combination of white color and translucence



Figure 8.16. Agate/chalcedony.

Artifact Types	Geological Formation/ Origins	Code Description
Mostly chipped-stone artifacts, especially projectile points	Found in isolated outcrops in the Dakota Sandstone and the Burro Canyon Formation. This is the end product of the dissolution and precipitation of silica	A = Agate CH = Chalcedony

Washington Pass Chert (WPC)

Washington Pass chert is a very finegrained, siliceous, translucent material that is composed primarily of chalcedony (Figure 8.17). Its color generally varies from shades of pale pink to reddish orange. It is notable for its “waxy” texture. This material comes from the Narbona Pass area (formerly named “Washington Pass”) in the Chuska Mountains on the Arizona—New Mexico border. Because of its excellent flaking characteristics it was traded throughout the Southwest; it is especially common in Chaco Canyon sites.

Washington Pass Chert (WPC)	
Color	shades of pinkish to reddish orange; can also contain small nodules or blebs of white or gray chalcedony
Opacity	varying degrees of translucence, occasionally transparent
Grain size	amorphous, nongranular
Texture/hardness	very smooth; often has a “waxy” feel
Appearance	very shiny, sometimes glassy
Characteristic features	waxy texture, pink to orange color



Figure 8.17. Washington Pass chert. Note the Chalcedony blebs visible below the surface

Artifact Types	Geological Formation/ Origins	Code Description
Debitage, cores, bifaces, and projectile points	Formed by hydrothermal precipitation of silica during formation of the Chuska mountains; found as nodules weathering out of the igneous cap rock at Narbona Pass	WPC = Three-letter abbreviation for Washington Pass chert

Obsidian (OBS)

Obsidian is a volcanic glass (Figure 8.18) that produces the sharpest edge of any stone material. It is usually black and transparent to highly translucent. Depending on its source, however, it can also be brown, gray or a streaked combination of colors, and it can have low translucence or even be opaque. The closest natural sources of obsidian are in the Jemez Mountains and Mt. Taylor in New Mexico, and the San Francisco Peaks in Arizona. Obsidian was widely traded throughout the southwest.

Obsidian (OBS)	
Color	mostly black, although it can be brown or black with streaks of brown
Opacity	often transparent or highly translucent, although some varieties are relatively opaque
Grain Size	nongranular, amorphous
Texture/hardness	very smooth, brittle
Appearance	glassy
Characteristic features	dark (usually black) color, high translucence, sharpness, and glassy appearance



Figure 8.18. Obsidian. Note its glasslike qualities.

Artifact Types	Geological Formation/ Origins	Code Description
bifaces, projectile points, and small flakes removed during tool retouch	Obsidian is melted silica that forms under certain volcanic conditions. Most of the specimens from southwestern Colorado that have been sourced can be traced to the Jemez Mountains of New Mexico	OBS = Three-letter abbreviation for obsidian.

Rare Stone Materials

These materials are not given the same in-depth treatment as the preceding stone materials due to their rarity in stone artifact assemblages. Consult with a staff member when identifying these rare stone materials.

Caliche (CAL)

Caliche is a fine-grained salt (calcium carbonate) present in deep soils in the Mesa Verde region. It is white and always opaque, and because it is of the same chemical composition as chalk, it has a soft, chalklike texture. It may have been used in wall plaster and as a white pigment.

Jet (JET)

Jet is metamorphosed coal. It is black, always opaque, and though harder than coal, is still moderately soft. It was used primarily for ornaments.

Concretion (CON)

Concretions are concentrations of iron oxide found in sandstone formations such as the Dakota Sandstone. They are usually cylindrical or spherical in shape, are a rusty brown color, and have smaller grains than those in the surrounding sandstone. They may have been used to make mineral-based paints, and were collected and used in rituals by historic Pueblo Indians.

Quartz (QTZ)

Quartz is a crystalline form of silica. It is white to clear, hexagonal in shape, and highly transparent. This mineral was collected and used in rituals by historic Pueblo Indians.

Gypsum/Calcite/Barite (GCB)

These three minerals are found as isolated crystal formations in several sedimentary formations throughout the American southwest. They are usually transparent and have a distinct crystal structure. These minerals were collected and used in rituals by historic Pueblo Indians.

Turquoise (TUR)

Turquoise is a green to bluish green mineral with very smooth texture. It is found in parts of New Mexico, Arizona, Nevada, and northern Mexico, and is considered nonlocal when found in southwestern Colorado sites. It was used primarily for ornaments such as beads, pendants, and tesserae.

Step 4: Record Unknown Stone Materials

Use these codes for materials that cannot be assigned to any of the categories discussed in the previous pages. you will need the assistance of a staff member to distinguish clearly nonlocal stone from stone that is unknown (may or may not be nonlocal).

**NonLocal Chert /Siltstone
(NCS)**

Other Mineral(MIN)

**Unknown Chert/Siltstone
(UCS)**

**Unknown Stone
(UNS)**

**Unknown
Quartzite/Silicified
Sandstone (USS)**

Chapter 9

Bulk Chipped Stone Analysis

This chapter presents the procedures we use in analyzing bulk chipped stone in our lab. Bulk chipped stone is one of the bulk artifact categories into which artifacts are separated during the cataloging process described in Chapter 3. This artifact category consists of *debitage*, which includes flakes and angular debris generated during stone tool manufacture; and *flake tools*, which includes flakes that were used for cutting, slicing, or scraping, and flakes that were modified for such uses. Bulk chipped stone analysis is done with adult participants, interns, volunteers, and staff. Depending on the size of the collection, the nature of our sampling strategy, and the nature of our research questions, we may analyze the entire bulk chipped stone assemblage or select a sample for analysis.

Our analysis of bulk chipped stone is largely a mass analysis (Ahler 1989*1; Patterson 1990*1; Shott 1994*1) as opposed to a detailed analysis of attributes of individual pieces of chipped stone (for a review of various approaches to lithic debitage analysis, see Andrefsky 1998*1: Chapter 6). Mass analysis approaches build on the experimental finding that the size of a piece of debitage is correlated with a number of attributes that reflect the stages of stone tool manufacture and maintenance. The size of a piece of debitage can be determined quickly and consistently using a set of screens with graded mesh sizes, and the distribution of debitage sizes obtained through size-sorting, combined with stone material identifications, provide coarse but adequate data for addressing our primary research goals: 1) to distinguish stone materials that were reduced from raw material at the site from stone materials for which initial reduction took place elsewhere; 2) to identify locations where various stages of stone tool production and maintenance occurred; 3) to identify the geologic source of each chipped-stone artifact as an aid in identification of trade items; and 4) to determine the stone materials and types of flakes that were selected for use as expedient flake tools.

Our methods are designed to collect a large amount of chipped-stone data efficiently and consistently. Although it is likely that more could be learned through detailed analysis of individual pieces, we have found that such an approach is too time intensive, relative to the size of our collections, the amount of time we have to process them, and the additional knowledge gained, for us to invest significant staff time in an attribute-based analysis of individual pieces. Also, we have found that it is difficult to achieve a consistent and replicable attribute-based analysis of bulk chipped stone working with participants in our public education programs. We therefore feel that mass analysis is an appropriate approach, given the context in which our laboratory operates.

Getting Started

You will need the following items in order to analyze a bag of bulk chipped stone:

- a bag of “bulk chipped stone” (Figure 9.1).
- a stack of bulk chipped stone analysis labels (Figure 9.2).
- a bulk chipped stone analysis form (Figure 9.3).



Figure 9.1. Bag of “bulk chipped stone.”

CROW CANYON ARCHAEOLOGICAL CENTER Bulk Chipped Stone Analysis Form

Site Number _____ PD _____ FS _____ PL _____

Bag Date _____ Date Analyzed _____ Analyst _____

DE initials _____ DE date _____

Chipped Stone Category	Item No.	Material Name	Material Code	Cortex	Size	Count	Weight	Comments

SITE: _____
PD _____ **FS** _____ **ITEM #** _____
CATEGORY _____ **MATCODE** _____
MATERIAL NAME:

CORTEX _____

Figure 9.2. Bulk chipped stone analysis label.

Figure 9.3 (Left). Top portion of Bulk chipped stone analysis form.

Step 1: Check Contents of Bulk Chipped-Stone Bag

Empty the bag of chipped stone onto a tray or table and remove the field specimen (FS) label (Figure 9.4). The contents line of this label should read “bulk chipped stone.” Copy all pertinent information from the label onto the top of the Bulk Chipped Stone Analysis Form (Figure 9.3). Draw a dash through any fields that do not have a corresponding entry on the FS label.

Next, look through the items. The pile should include only **debitage**, which includes flakes and angular debris (Figure 9.5), and **flake tools**, which consist of flakes that exhibit evidence of use (utilization) or intentional modification (see definitions on pages 9-4 and 9-5). Nothing that we would categorize as an individual chipped-stone artifact—such as a core, biface, or projectile point—should be in the bag (see Chapter 4 for descriptions of individual chipped-stone artifacts). Any such items that you do find in the bag were overlooked during cataloging and should be removed now and cataloged as individual artifacts. Put each individual artifact you find in its own bag and fill out an FS label for each one, leaving the FS number blank (Figure 9.4). These objects will be assigned new FS numbers later (see Chapter 3 for instructions on how to assign FS numbers).

NOTE: Do not change the count and weight on the FS label of the bulk chipped stone, even if you remove one or more individual artifacts from the bag. The analysis data you are about to collect will supercede these data, and we often use the counts and weights as originally entered in the database to track down labeling errors.

SITE: <u>5MT123</u>	DE date <u>9/2/03</u>	Date _____ Analyst _____	
PD <u>1293</u>	FS <u>3</u>		PL <u>----</u>
STUDY UNIT <u>NST 133</u>			
HOR. <u>1x2 502.1N 489.5E</u>			VERT. <u>FULC</u>
FEATURE <u>-----</u>			
HOR. <u>-----</u>			VERT. <u>-----</u>
BAG DATE <u>7/14/03</u>			FIELD SUP. <u>SCR</u>
CONTENTS <u>Bulk Chipped Stone</u>			
Count <u>11</u>	Weight <u>43.1</u>		

Figure 9.4. Sample FS label for a bag of Bulk Chipped Stone.

Figure 9.5 (Right).
Unsorted bulk
chipped stone.



See Step 2 for definitions of
debitage, flakes, angular
debris, modified flakes and
utilized flakes.



Step 2: Definitions (Page 1 of 2)

Debitage is defined as artifacts created by chipping pieces of stone off of a parent stone. Debitage is generated during the manufacture and maintenance of chipped-stone tools, as well as the shaping of architectural stone. Debitage is generally angular, has sharp edges, and includes both flakes and angular debris.

Flakes have characteristics that distinguish them from stones that are broken naturally (Figure 9.6). The ventral side of a complete flake (the side facing toward the core when it was struck) should have a bulb of percussion, a striking platform and ripple marks. It may also exhibit errailles, which are leaf-shaped scars left when small flakes pop off the bulb of percussion during the striking of the larger flake. The dorsal side (the side facing away from the core when it was struck) may exhibit partial negative scars from flakes that were removed previously from the core. For further reading, see Andrefsky (1998*1) and Whittaker (1994*1).

Angular debris, also called shatter, is a by-product of chipped-stone tool manufacture. It consists of irregular, angular pieces of stone that lack a bulb of percussion and clear ventral and dorsal surfaces. We do not distinguish flakes from angular debris in this analysis, but it is an important distinction in more detailed analyses.

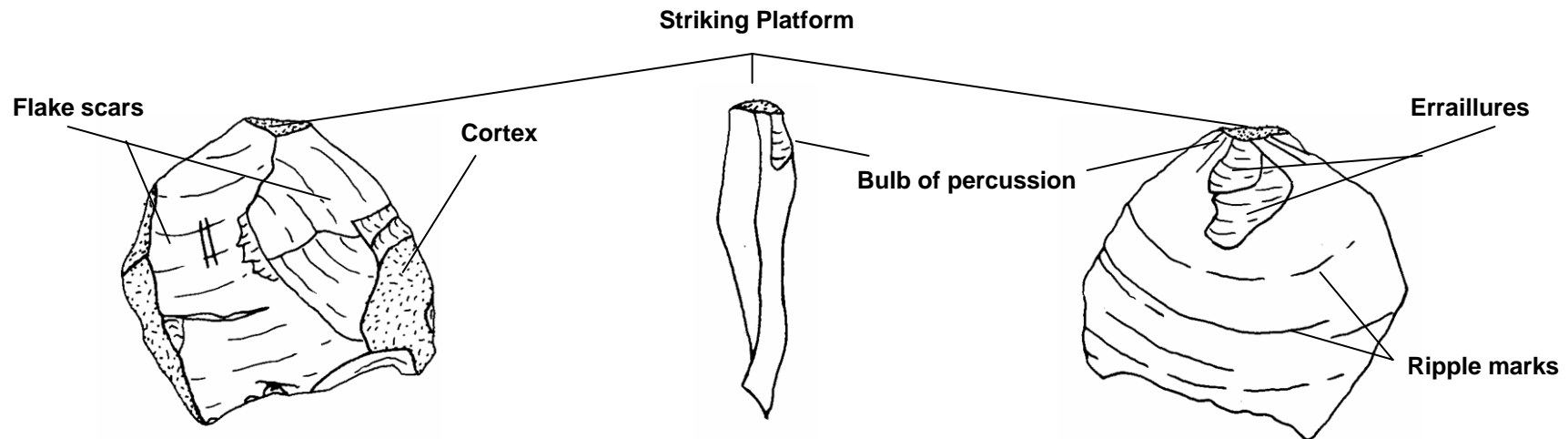

Figure 9.6. Three views of a chipped stone flake. Left, dorsal view; center, lateral (side) view; right, ventral view.

Definitions (Page 2 of 2)

Flake Tools: Although neither are classified as debitage, two types of chipped-stone tools made from flakes are included in bulk chipped stone during cataloging. These simple, expedient tools are analyzed along with debitage because they still possess some characteristics of the original flakes from which they were made and therefore provide important information about chipped-stone tool manufacture. However, these artifacts can also tell us about tool *use*, so we identify and record data for each individual item during bulk chipped-stone analysis. Modified and utilized flakes are easily overlooked, so please pay careful attention to the following definitions:

Modified flakes (Figure 9.7) were intentionally modified along at least one edge to create a simple tool used for scraping, slicing, or cutting. Modified flakes were made either by pressure-flaking an edge with an antler tine or by soft-hammer percussion of an edge using an antler base. Either method would produce a series of small, uniform flake scars at regular intervals. The purpose of this modification was to resharpen an edge that had been dulled by use, or to change the angle of an edge so it would work better for a specific task.

Utilized flakes (Figure 9.8) were sldo used for cutting, scraping, or slicing. These are simply flakes that were used as tools with no additional preparation. The edge that was used will appear chipped, worn, dulled, or broken, and any flakes removed through use will be tiny and irregular (not patterned).

On modified flakes, the flakes along the modified edge(s) are larger and more regular (patterned) than those on a utilized flake.

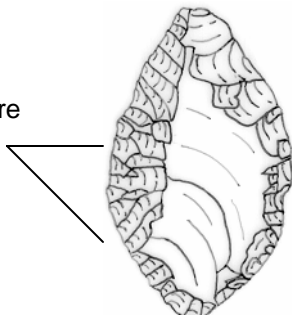

Figure 9.7. Modified flake.

On utilized flakes, any flakes along the used edge will be more irregular in size, shape, and placement than those on a modified flake.

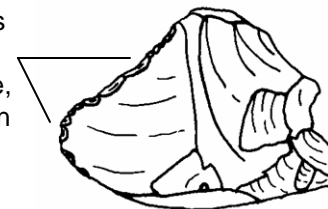

Figure 9.8. Utilized flake.

Step 3: Sort Flake Tools vs. Debitage

Sort the chipped stone into three categories: modified flakes, utilized flakes and debitage. Be sure to look at each piece carefully, and examine all edges for evidence of modification or use. If none is found, the item should be placed in the debitage pile. Modified and utilized flakes are relatively rare, so not every bag of bulk chipped-stone will contain one of these items. Be sure to have a staff member check your work.

If you have any modified flakes or utilized flakes you should fill out an analysis label for each one (Figure 9.9). The site number will normally be printed on the analysis labels when they are generated by the computer. You should transfer the PD and FS numbers from the FS label. Then, assign an item number to each flake tool, beginning with “1” continuing sequentially for each flake tool you identify within this bag. Then, enter the appropriate chipped-stone category code for each flake tool to indicate whether the item is a modified flake (M) or a utilized flake (U). Once you have filled out this information, place each flake tool on its corresponding label and set it aside.

If you find any flake tools, write the appropriate chipped stone category code here.

“M” for modified flake.

“U” for utilized flake.

SITE: 5MT123		
PD _____	FS _____	ITEM# _____
CATEGORY _____	MATCODE _____	
MATERIAL NAME: _____		
CORTEX _____		

Item numbers are assigned to each flake tool. Item numbers are assigned consecutively, beginning with “1,” to each modified and utilized flake found in and FS of bulk chipped-stone.

Set the flake tools aside for now and continue to Step 4, where you will sort the debitage by stone material type.

Figure 9.9. Where to enter the chipped-stone category on the analysis label.

Step 4: Sort Debitage by Stone Material Type

Return to the large pile ofdebitage and sort it by stone material type (Figure 9.11). The procedures for identifying stone material types are given in “Chapter 8: Stone Material Identification.” You will need to consult this chapter and follow the instructions it contains to accomplish this step. You should place each piece ofdebitage into a pile corresponding to its stone material type. The stone material types we recognize are listed in Figure 9.20 (Page 9-13).

Once you have sorted thedebitage by material type, fill out an analysis label for each resultant pile (Figure 9.12). As was the case for the flake tools, you should transfer the PD and FS numbers from the FS label; however, we do not assign item numbers todebitage, so you should enter a dash (—) in the item number space for all labels that correspond todebitage. Then, enter a “D” for the chipped-stone category to indicate that the label corresponds todebitage. Once you have filled out this information, place the label with the corresponding pile ofdebitage . Each label should have the PD, FS, Artifact Category, Material Name and Material Code filled out. Be sure to have a staff member check your sort before going on to the next step.



Figure 9.11. Participants sortingdebitage by material type.

The chipped-stone category fordebitage is “D”.

Item numbers are not assigned todebitage. Enter a dash (—) if the chipped-stone category is “D.”

Matcode: The three-letter abbreviation for the stone material type of the objects described by the label (from Figure 9.21).

Material Name: The material type name corresponding to the material code, written out (from Figure 9.21).

SITE: 5MT123		
PD	FS	ITEM#
CATEGORY	MATCODE	
MATERIAL NAME:		
CORTEX		

Figure 9.12. What to enter on the analysis label for each pile ofdebitage of a given stone material.

Step 5: Sort Material Types by the Presence or Absence of Cortex

Determine whether each piece of debitage has cortex or not. **Cortex** is the natural, weathered exterior surface of the parent rock from which the chipped-stone artifact was struck. It can be thought of as a “rind” that forms over time as the stone is exposed to the environment. Cortex will often have a different color, texture and luster than the interior of the rock.

The first step in chipped-stone tool manufacture was to remove the cortex from piece of raw material. Thus, we record the presence or absence of cortex during chipped-stone analysis to help us determine whether primary reduction of specific raw materials occurred in a given location.

To sort debitage based on the presence or absence of cortex, examine each piece in each stone material pile. On flakes, look for cortex on the striking platform and dorsal surface (the side facing out from the core from which it was struck), and on angular debris, examine all surfaces. Split each stone material pile from Step 4 into two piles, one that consists of pieces with cortex and a second that consists of pieces lacking cortex. Once you have accomplished this sort, you will need to fill out a second analysis label for each stone material type, and indicate the presence of cortex on one label, and the absence of cortex on the other (Figure 9.13).

SITE: 5MT123	
PD _____	FS _____ ITEM# _____
CATEGORY _____	MATCODE _____
MATERIAL NAME: _____	
CORTEX _____	← _____

Cortex: Record presence (P) or absence (A) of cortex.

Figure 9.13. Where to indicate the presence or absence of cortex on the analysis label.

Step 6: Complete Steps 4 and 5 for Flake Tools and Check Analysis Labels

After you have sorted all debitage by stone material type and by the presence or absence of cortex, and have filled out an analysis label for every resultant pile, you should return to the flake tools and make the same determinations for each itemized flake tool from Step 3. Because each flake tool will already have an analysis label started from Step 3, you should add information to the existing label as you determine the stone material type and presence or absence of cortex for each item.

You should now have a completely filled-out analysis label for each modified flake, utilized flake, and pile of debitage of a given stone material type and cortex status. Figure 9.14 reviews what should be recorded in each space of each analysis label. The analysis codes are also summarized in Figure 9.20 (page 9-13).

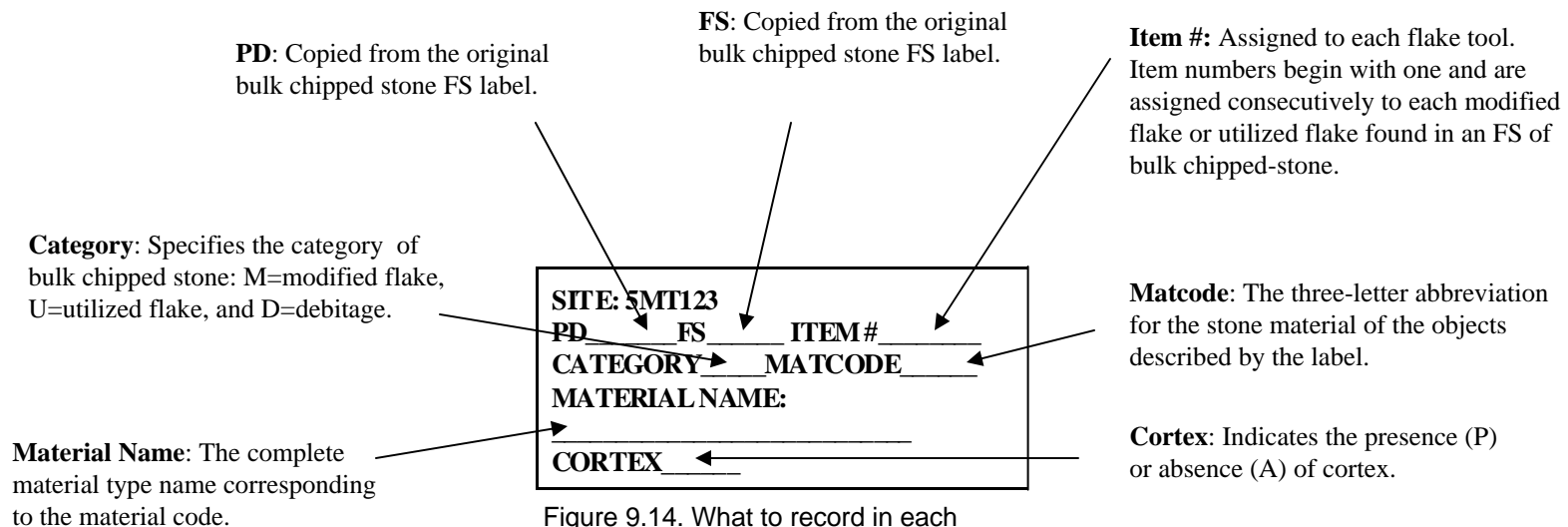

Figure 9.14. What to record in each space on the analysis label.

Step 7: Sort One Category-Material-Cortex Group by Size

In this step you will determine the size of each artifact. This information is important because debitage from early stages of chipped-stone-tool production tends to be larger than debitage from later stages. To determine size we use a set of nested screens with different mesh sizes (Figures 9.15-9.18).

By now you may have many piles of chipped stone on the table, each one with an analysis label that describes the attributes of that particular “category-material-cortex” group. Note that each flake tool should have an item number and will fall into its own group. Select one group and carefully place the artifact(s) in that group into the nested screens, which are stacked top to bottom in order of decreasing mesh size (Figure 9.17). Gently shake the screens to get the flakes to drop through. Any artifact that can pass through a screen in any direction without forcing should be put through.



Figure 9.15. A nested set of screens for size-sorting bulk chipped stone.



Figure 9.16. Disassembled set of screens. Left to right: Bottom tray (no mesh), 1/4-inch mesh, 1/2-inch mesh, and 1-inch mesh.



Figure 9.17. Dropping artifacts into the screens. The screens are stacked so that the screen with the largest mesh (1-inch) is on the top and the screen with the smallest mesh (1/4-inch) rests on the bottom tray.



Figure 9.18. After screening: the debitage found in the bottom (<1/4-inch) tray.

When you have finished size-sorting a group, you will record the information for each category-material-cortex-size group on the Bulk Chipped Stone Analysis Form in Step 8.

Note: Each flake tool will have an item number and will fall into its own category-material-cortex group.

Step 8: Fill Out the Analysis Form

In this step you will record all the data generated during steps 1 through 7 on the Bulk Chipped Stone Analysis Form (Figure 9.19). Fill out the form for each “category-material-cortex” group as you sort the group by size, using the following sub-steps:

- a) Copy the analysis data recorded on the analysis label onto a line of boxes on the form, including the chipped stone category, material name, material code, and cortex code for that group.
- b) Then record the size category of the largest-mesh screen that has artifacts in it: 1=1-inch mesh; 2=½-inch mesh; 4=¼-inch mesh; 5=<¼-inch mesh (bottom tray) (see Figure 9.20).
- c) Count and weigh the artifacts in this screen (see Chapter 3 for information on weighing artifacts) and record these data in the appropriate spaces on that line.
- d) Record comments that are relevant to a given category-material-cortex-size group. Things to record in comments include: evidence of burning or heat treatment, the deposition of precipitate, evidence that one or more flakes derived from tools (such as an axe or hammerstone), and the location and nature of modification or use. Consult a staff member for the appropriate notes to make in the comments box.
- e) Repeat sub-steps a-d for each screen with smaller mesh containing artifacts until all the artifacts in the category-material-cortex group have been accounted for (see Figure 9.19).
- f) Once all the artifacts in a category-material-cortex group have been recorded, the artifacts from the various screens should be grouped back together and placed in an appropriately-sized plastic bag along with the analysis label facing outward so it can be read through the bag.
- g) Then repeat Steps 7 and 8 for the next category-material-size group until all such groups have been recorded on the analysis form and bagged with their associated analysis labels.

**CROW CANYON ARCHAEOLOGICAL CENTER
Bulk Chipped Stone Analysis Form**

Figure 9.19 (right). A
Filled-out Bulk Chipped
Stone Analysis Form

Site Number 5MT123 PD 16 FS 7 PL ----
 Bag Date 5/1/01 Date Analyzed SGO Analyst 10/9/02 DE initials LFJ DE date 6/19/03

Brackets indicate artifacts of the same category-material-cortex group, which are bagged together after they have been size-sorted, counted, weighed, and recorded.

Chipped Stone	Item No.	Material Name	Material	Cortex	Size	Count	Weight	Comments
D	-	Morrison Silicified Sandstone	JMS	A	1	1	49.5	
D	-	Morrison Silicified Sandstone	JMS	A	2	18	81.4	One piece is an axe fragment.
D	-	Morrison Silicified Sandstone	JMS	A	4	41	32.6	
D	-	Morrison Silicified Sandstone	JMS	P	1	2	28.3	
D	-	Morrison Silicified Sandstone	JMS	P	2	10	67.1	
D	--	Morrison Silicified Sandstone	JMS	P	4	8	8.4	
D	-	Morrison Mudstone	KJM	A	1	1	49.0	
D	--	Morrison Mudstone	KJM	A	2	4	25.5	
D	--	Morrison Mudstone	KJM	A	4	14	6.3	
D	-	Morrison Mudstone	KJM	P	2	5	21.4	
M	1	Burro Canyon chert/siltstone	KBC	A	2	1	1.0	Modification on two margins.
U	2	Morrison Chert	KJC	A	1	1	23.1	Use wear on tip.

**CROW CANYON ARCHAEOLOGICAL CENTER
BULK CHIPPED STONE ANALYSIS CODES**

CHIPPED STONE CATEGORY

D = debitage
M = modified flake
U = utilized flake

MATERIAL CODES AND NAMES

ACH = agate/chalcedony
CAL = caliche
COG = conglomerate
CON = concretion
GCB = gypsum/calcite/barite
JET = jet
JMC = Brushy Basin chert (old code: BBC)
JMS = Morrison silicified sandstone (old code: MQT)
KDB = Dakota/Burro Canyon silicified sandstone (old code: DQT)
KBC = Burro canyon chert (old code: BUR)
KJC = Morrison chert (old code: MCS)
KJM = Morrison mudstone (old code: MCS)
MIN = other mineral
NCS = nonlocal chert/siltstone
OBS = obsidian
OIG = other igneous
PET = petrified wood
PMS = Porter mudstone
QTZ = quartz
RJS = red jasper
SND = sandstone
SLS = slate/shale
TUR = turquoise
UCS = unknown chert/siltstone
USS = unknown quartzite; unknown silicified sandstone (old code: UQT)
UNS = unknown stone
WPC = Washington Pass chert

SCREEN SIZE

1 = 1" screen
2 = 1/2" screen
4 = 1/4" screen
5 = < 1/4" screen

CORTEX

P = present
A = absent

Figure 9.20. Bulk Chipped Stone Analysis Codes.

Step 9: Bag the Analyzed Bulk Chipped Stone

The last step in the analysis is to package the analyzed artifacts for storage. Each bag containing a category-material-cortex group with analysis label will go back into the original bulk chipped stone bag you emptied at the beginning of the analysis. The category-material-cortex bags do not need to be twist-tied unless the contents are in danger of spilling out. As you put these bags back in the original bag, be sure each one has an analysis label inside, and check the analysis form to be sure that the contents of each bag were recorded correctly.

REMEMBER: Each modified or utilized flake should have been bagged individually, should have an analysis label with a unique item number on it, and should have a line of data on the analysis form for that specific item.

When everything has been checked and any errors corrected, the analysis date and analyst's initials (for participants, these are the initials of the staff member who checked your work) should be recorded in the spaces provided along the right edge of the original FS label (Figure 9.21), and then this label should be inserted in the bag facing out so it can be read from the outside. Finally, close the bag with a twist tie (Figure 9.22) and give the bag and analysis form to a staff member.

SITE: <u>5MT123</u>	DE date <u>9/2/03</u>	Date _____ Analyst _____	
PD <u>1293</u>	FS <u>3</u>		PL <u>----</u>
STUDY UNIT <u>NST 133</u>			
HOR. <u>1x2 502.1N 489.5E</u>			VERT. <u>FULC</u>
FEATURE <u>-----</u>			
HOR. <u>-----</u>			VERT. <u>-----</u>
BAG DATE <u>7/14/03</u>			FIELD SUP. <u>SCR</u>
CONTENTS <u>Bulk Chipped Stone</u>			
Count <u>11</u>	Weight <u>43.1</u>		

Figure 9.21 (Left). Enter the analysis date and analyst's initials on the right edge of the original FS label of the Bulk Chipped Stone bag you have just analyzed when you finish the analysis.



Figure 9.22. Bagging bulk chipped stone artifacts after analysis.

Chapter 10

Detailed Stone Artifact Analyses

This chapter provides a guide to detailed analyses we perform on various categories of individual stone artifacts. This includes analyses we conduct as part of our standard procedure, and analyses we have performed on specific artifacts in specific collections to address project-specific research questions. The majority of this chapter describes our standard, detailed analysis of formal chipped-stone tools, which include bifaces, projectile points, and drills. A second section at the end of the chapter describes the analysis data we collect from other stone artifacts, either as part of our standard procedure or as part of problem-oriented studies.

Analysis of Bifaces, Projectile points, and Drills

Formal chipped-stone tools are first identified during cataloging (Chapter 3), and at that time the condition, material, and weight of each artifact are recorded on the FS Form. After the entire collection from a site has been cataloged and a consistency check of all individual stone artifacts has been completed (see Chapter 13), staff, interns, and/or volunteers record additional data from all formal chipped-stone tools in the collection on the Biface Analysis Form (Figure 10.1). We perform this detailed analysis as part of our standard procedure because formal chipped-stone tools possess more interpretive potential than many other stone artifacts. Over the years, archaeologists have used formal-chipped-stone-tool data to address questions of chronology, production and exchange, cultural identity, and specific cultural practices such as hunting and warfare.

The goals of our analysis of formal chipped-stone tools are: 1) to assess the most probable initial function of each tool (the final use of each artifact is reflected in the artifact category, which was recorded during cataloging); 2) to assess the relative age and cultural affiliation of each projectile point by determining its culture-historical type, when possible; 3) to collect basic metric data that can be used by future researchers; and 4) to collect technological data about the manufacture and “life histories” of these artifacts. Although most artifacts we classify as bifaces, projectile points, or drills are truly formal, bifacially-flaked tools that were deliberately shaped to fit a pre-conceived template, some artifacts assigned to these categories were not formally-shaped, including drills that were neither bifacially-flaked nor hafted, and bifaces that were neither formal tools nor formal tool preforms. We nevertheless analyze every artifact that is assigned to one of these three categories, regardless of its degree of formality.

The following paragraphs explain how the Biface Analysis Form is filled out. When performing this analysis, analysts enter a dash (–) for all items that are not applicable, or where the object is not complete enough to warrant the measurement or description.

Crow Canyon Archaeological Center Biface Analysis Form

4/27/05

Analyst _____ Date _____

Tracing

Provenience:

Site Number: _____ PD: _____ FS: _____

B. Morphology (measurements in 100ths of a cm):

Max. Length: _____ Max. Width: _____

Max. Thickness: _____ Notch Width: _____

Neck Width: _____ Notch Locations: _____

Max. Width Location: _____ Size Class: _____

Portion Present: _____ Side Shape: _____

Base/Stem Shape: _____ Serration?: _____

C. Technology/Function:

Primary Function: _____ Reduction Stage: _____

Blank Form: _____ Cortex: _____

Use-Phase: _____ Rejection: _____

Edge Grinding: _____ Use Wear: _____

Fracture Location: _____ Raw Material: _____ Resharpened?: _____

D.Type: _____ **E.Comments:** _____

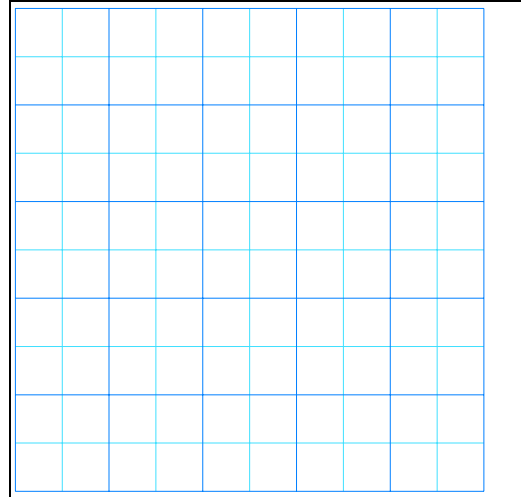

Figure 10.1. Biface Analysis Form

Provenience

Copy the Site, PD number, and FS numbers from the FS label associated with the artifact to the appropriate spaces on the Biface Analysis Form.

Morphology

Tool morphology is described in terms of a variety of quantitative measurements and qualitative attributes. All measurements are recorded to the nearest hundredth of a centimeter. Descriptions of the attributes are listed below. The locations of the measurements and attributes are provided below. The parts of a projectile point and several basic measurements are illustrate in Figure 10.2.

Biface/Projectile Point Morphological Terminology

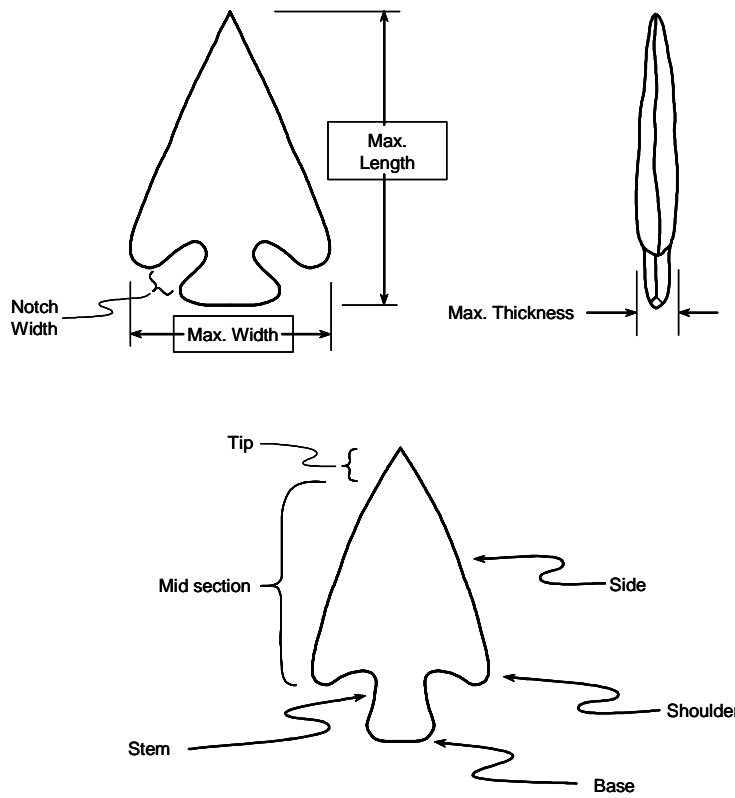

Figure 10.2. Projectile Point Morphology.

Maximum Length: The maximum linear dimension between the tip and base of the tool.

Maximum Width: The maximum cross section preserved between the lateral edges of the tool. This measurement is perpendicular to the length.

Maximum Thickness: This measurement is also perpendicular to the length, but it spans the maximum distance between the two faces of the tool.

Notch Width: The distance between the shoulder and the corner of the base on a projectile point. This measurement is taken only if the point is notched or stemmed and the complete width can be measured. If both notches are preserved, both are measured and the average distance is recorded.

Neck Width: The minimum distance between the notches. Record a dash (–) if the tool does not have notches.

Notch Locations: Record the location of notches (hafting elements) on a tool (Table 10.1). Multiple values may be entered for this attribute, separated by commas.

Code	Description
C	corner
S	side
B	base
N	no notches
I	indeterminate

Maximum Width Location: The place on the tool where the maximum width was recorded (Table 10.2).

Code	Description
S	sides
H	shoulder
B	base
I	indeterminate or incomplete

Size Class: Projectile points with complete necks are assigned to one of the three size classes defined in Table 10.3, based on the width of the neck. If the neck is incomplete, then the point is assigned to the “indeterminate” size class.

Table 10.3. Size Class	
Code	Description (neck width)
S	small (<6 mm)
M	medium (6 to 10 mm)
L	large (>10 mm)
I	indeterminate (incomplete neck)

Portion Present: Record the category that best describes the portion of the tool that is available for analysis (Table 10.4).

Table 10.4. Portion Present	
Code	Description
C	complete
TB	tip broken
TO	tip only
MO	mid-section only
MP	partial mid-section
BB	base broken
BM	base missing
BO	base/stem only
SB	shoulder/side broken
TBB	tip and base broken
TSB	tip and shoulder broken
SBB	shoulder and base broken
I	indeterminate

Shape of Sides: Record the general shape of the sides of the tool (Table 10.5).

Table 10.5. Side Shape	
Code	Description
S	straight
C	concave
X	convex
A	angled
I	indeterminate

Shape of Base or Stem: Record the shape of the base on a notched tool, and the shape of the stem on a stemmed tool (Table 10.6). Definitions of stem shapes may be found in Holmer (1986*1).

Code	Description
SB	straight base
CB	concave base
XB	convex base
CS	contracting stem
ES	expanding stem
SS	straight stem
I	indeterminate

Serration: Record the presence (Y) or absence (N) of serrated edges. If no edges are present, or if too little of an edge is preserved, record this attribute at indeterminate (I).

Technology/Function Data

Technology and function data, unlike the morphological data, are all qualitative in nature. These are largely subjective assessments, and thus are prone to revision in future analyses.

Primary Function: The original intended use of the object as inferred on the basis of gross morphology, *not* use-wear analysis (Table 10.7).

Code	Description
A	arrow point (small)
D	atlatl dart
B	blade (knife or spear)
R	drill
I	indeterminate

Reduction Stage: The latest stage of bifacial reduction evident on the tool. The particular stages used derive from Whittaker (1994*1:199-206), with slight changes in the numbering sequence (Table 10.8).

Code	Description
S1	bifacially-edged blank
S2	primary thinned preform
S3	refined biface
S4	finishing
F	finished
I	indeterminate

N	not applicable
---	----------------

Blank Form: The type of blank from which a tool was produced (Table 10.9). These blank types are discussed in Andrefsky (1998*1) and Whittaker (1994*1).

Code	Description
F1	other (non-bipolar) flake
F2	biface thinning flake
F3	bipolar flake
F4	bifacially-reduced blank
F5	indeterminate

Cortex: Record the presence (P) or absence (A) of cortex on the tool. See page 9-8 for further information on how to identify cortex.

Use-Phase: This attribute refers to whether the tool was finished or unfinished, usable or unusable, when it was deposited in the archaeological record (Table 10.10). Unbroken tools are generally assumed to have been usable even if they were unfinished. Broken, burned, or poorly made tools are usually inferred to have been unusable. The inferred reason for discard is recorded under "Rejection," below.

Code	Description
1	unfinished, usable
2	unfinished, unusable
3	finished, usable
4	finished, unusable

Rejection: A subjective assessment of the reason why a tool was discarded (Table 10.11). For definitions of fracture types see Cotterell and Kamminga (1979*1) and Whittaker (1994*1). If no reason for discard is apparent, enter "R10" (indeterminate).

Code	Description
R1	limited potential for further work/use
R2	bending fracture/end shock
R3	material flaw/quality
R4	outré-passe fracture

R5	compound hinge/step occurrence
R6	impact fracture
R7	heat fracture
R8	lateral break
R9	crescentic chunk from margin
R10	indeterminate

Edge Grinding: Describe the location(s) of edge grinding on the tool, if such grinding is present. Edge grinding is a characteristic of Archaic projectile points in the Southwest (Table 10.12).

Table 10.12. Edge-Grinding Location	
Code	Description
S	sides
B	base
A	all edges
N	none
I	indeterminate

Use Wear: Record the type(s) and locations(s) of macroscopic use wear (Table 10.13). More than one type of use wear may be recorded for a given item.

Table 10.13. Use Wear	
Code	Description
T	tip re-sharpened
R	retouching of blade
D	wear from drilling
H	repaired haft
U	use wear on blade
I	indeterminate
N	no use wear

Fracture Location: Record the locations of fractures that are inferred to be related to the use of the tool. Record as many options as are relevant (Table 10.14).

Table 10.14. Fracture Location(s)	
Code	Description
B	blade
T	tip
S	shoulder

H	haft or base
L	lateral body
I	indeterminate
N	no fractures

Raw Material: Copy the stone raw material category recorded for this tool during cataloging. We copy this information onto the Biface Analysis Form because it is helpful to have all the information for a given artifact on a single piece of paper.

Type

Record the number corresponding to the type of which the point is an example. The projectile point typology used by Crow Canyon researchers is based on point styles defined by numerous archaeologists working over a period of many years in the Southwest. We keep a running list of recognized point types as we conduct this analysis and add new types to the end of our list as they are encountered in our collections or defined by other researchers. The point types included in our list to date are listed and briefly described in Table 10.15, below. Sources for more thorough descriptions of these types include Geib 1996*1; Hayes and Lancaster 1975*1; Holmer 1986*1; Irwin-Williams 1973*1; Lekson 1997*1; Matson 1991*1; and Thomas 1981*1. Selected types are illustrated in Figures 10.3, 10.4, and 10.5.

Code	Type Name/Description	Culture (Date Range)	Reference(s)
0	Projectile point, not further specified		
1	small, side-notched; unspecified base shape (if base shape can be determined, point should be classified as type 22, 23, or 24)	Pueblo II–Pueblo III (A.D. 900–1300)	Hayes and Lancaster 1975*1: 145, Style C
2	Large, corner-notched, with flaring tangs	Basketmaker III–Pueblo I (A.D. 500–900)	Hayes and Lancaster 1975*1: 145, Style A; Figure 10.3
3	Desert Side-Notched point: small, side-notched, with an expanding, concave base, with or without a basal notch.	Protohistoric Numic and Athabaskan groups (A.D. 1150–1750)	Thomas 1981*1

4	Small corner-notched; of the Rosegate series	A.D. 300–1000	Hayes and Lancaster 1975*1: 145, Style B; Holmer 1986*1
5	Short Bull Creek point, total length of 4.0 cm or less, straight sides, concave base, and no notches	Pueblo III in southeast Utah (A.D. 1100–1300)	Geib 1996*1: 107
6	Large, corner-notched point with convex base	Basketmaker II (B.C. 1000–A.D. 500)	Matson 1991*1: 80
7	Medium corner-notched	Middle and Late Pueblo II (A.D. 1050–1150)	Hayes and Lancaster 1975*1: 145, Style B
8	Biface, not further specified		
9	Drill, not further specified		
10	Cottonwood Triangular: a small, triangular point with a straight base and no notches	Pueblo II–Protohistoric in southeast Utah (A.D. 950–1750)	Holmer 1986*1; Figure 10.4
11	Small, contracting-stemmed	Pueblo II–Pueblo III (A.D. 900–1300)	
12	Long Bull Creek point, total length of 4.5 cm or more, straight sides, concave base, and no notches	Fremont in southeast Utah (A.D. 1000–1300)	Geib 1996*1: 107
13	Medium side-notched	Pueblo II–III (A.D. 900–1300)	Hayes and Lancaster 1975*1: 145, Style C
14	Medium-size point with thin corner-notches, possibly of the Rosegate series	Pueblo II in New Mexico (A.D. 900–1150)	Lekson 1997*1; Hayes and Lancaster 1975*1: 145, Style B
15	Elko Corner-Notched: large (neck width greater than 1.0 cm) triangular point with expanding stem and tanged corners (down-sloping shoulders)	Archaic (8500–1000 B.C.)	Holmer 1986*1; Figure 10.5

16	Elko Eared: large triangular point with concave base and expanding stem	Late Archaic (1500 B.C.–A.D. 500)	Holmer 1986*1; Figure 10.5
17	Rocker Side-Notched: large lanceolate point with semicircular, smooth basal edges and moderately high side notches	Middle Archaic (3500-1500)	Holmer 1986*1; Figure 10.5
18	Sudden Side-Notched: large triangular-shaped point with high side-notches, contracting stem, and slightly convex bases and blade edges	Middle Archaic (3500-1500 B.C)	Holmer 1986*1; Figure 10.5
19	Bajada/Pinto Stemmed: large dart point with relatively high shoulders and indented or concave base that cannot be identified specifically as a Bajada Stemmed (Type 30) or Pinto Stemmed (Type 29) point	Archaic (8500–1000 B.C.)	Holmer 1986*1; Irwin-Williams 1973*1; Figure 10.5
20	Armijo Complex point: short, with wide expanding stem, serrated blade edges, slightly concave base, and possible shallow corner notches	Archaic (8500–1000 B.C.)	Irwin-Williams 1973*1
21	Nawthis Side-Notched: a long point with low notches	Fremont in southern Utah (A.D. 1000–1300)	Holmer 1986*1; Figure 10.4
22	Small, side-notched, with straight base	Pueblo III (A.D. 1150–1300)	Hayes and Lancaster 1975*1: 145, Style C; Figure 10.4
23	Small, side-notched, with slightly concave base	Late Pueblo II (A.D. 1100–1150)	Hayes and Lancaster 1975*1: 145, Style C
24	Small, side-notched, with convex base	Pueblo III (A.D. 1150–1300)	Hayes and Lancaster 1975*1: 145, Style C; Figure 10.3
25	Archaic corner-notched, not further specified	Archaic (8500–1000 B.C)	

26	Parowan Basal-Notched: A long, triangular point with two basal notches	Fremont and Virgin Anasazi (A.D. 1000–1300)	Holmer 1986*1
27	Humboldt Basal-Notched: A large lanceolate point with concave base and a single basal notch	Archaic (8500–1000 B.C)	Holmer 1986*1
28	White Dog Point: large, corner-notched points with lanceolate-shaped sides	Basketmaker II (1000 B.C.–A.D. 5000)	Geib 1996*1: 63
29	Pinto Stemmed: A large, shouldered dart point with a split stem	Late Archaic (1500 B.C.–A.D. 500)	Holmer 1986*1
30	Bajada Stemmed: large, slightly-shouldered dart point with basal thinning and indentation	Early Archaic (8500–3500 B.C.)	Holmer 1986*1; Irwin-Williams 1973*1
31	San Jose Stemmed: large, shouldered dart point, shorter stem to blade ratio than in Bajada Stemmed, and serrated edges are common	Late Archaic (1500 B.C.–A.D. 500)	Holmer 1986*1; Irwin-Williams 1973*1

Additional Stone Artifact Analyses and Data

We record a variety of data from individual stone artifacts in addition to the data for bifaces, projectile points, and drills described above. Some of these data are recorded as part of our basic artifact processing procedures. For example, the weight, condition, and material of every stone artifact assigned to an individual artifact category is recorded during cataloging (Chapter 3). We also record the material, weight, size category, and presence or absence of cortex for each modified and utilized flake encountered during bulk chipped-stone analysis (Chapter 9). Modified and utilized flakes are clearly stone tools, but they are not distinguished as individual stone artifacts during cataloging because: 1) their identification is beyond the abilities of most students who catalog the majority of our collections; and 2) the kinds of information we want to collect from these tools are the same as those we record for debitage. We have therefore found it most efficient to include modified and utilized flakes along with debitage in our bulk chipped stone category during cataloging, and analyze them as part of bulk chipped stone analysis.

We collect additional stone artifact analysis data in ways that vary from project to project, depending on the specific research questions being pursued and the interests of the lab staff. For example, we have collected detailed information from two-hand manos, axes and mauls, and other modified stones over the years to address specific questions related to our research. For details on these specific, problem-oriented analyses, the reader should refer to reports generated

by our lab for various projects (%Lightfoot and Etzkorn 1993*1; %Pierce et al. 1999*2;
%Ortman 2000*2, 2002*1, 2003).

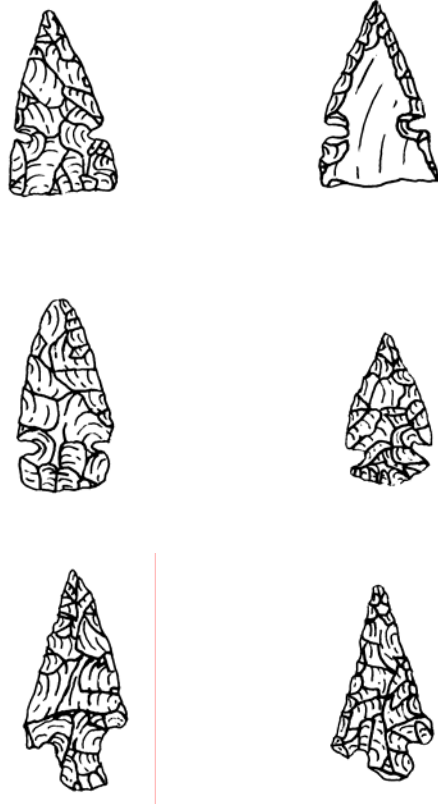

Figure 10.3. Projectile point types. Top row: Type 22. Middle row: Type 24. Bottom row: Type 2.

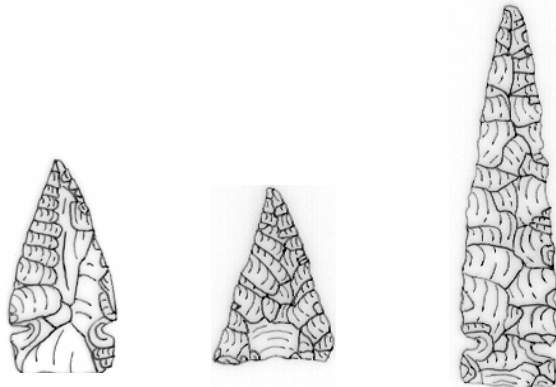

Figure 10.4. Examples of Type 22 (left), Cottonwood Triangular (Type 10, middle), and Nawthis Side-notched (Type 21, right).

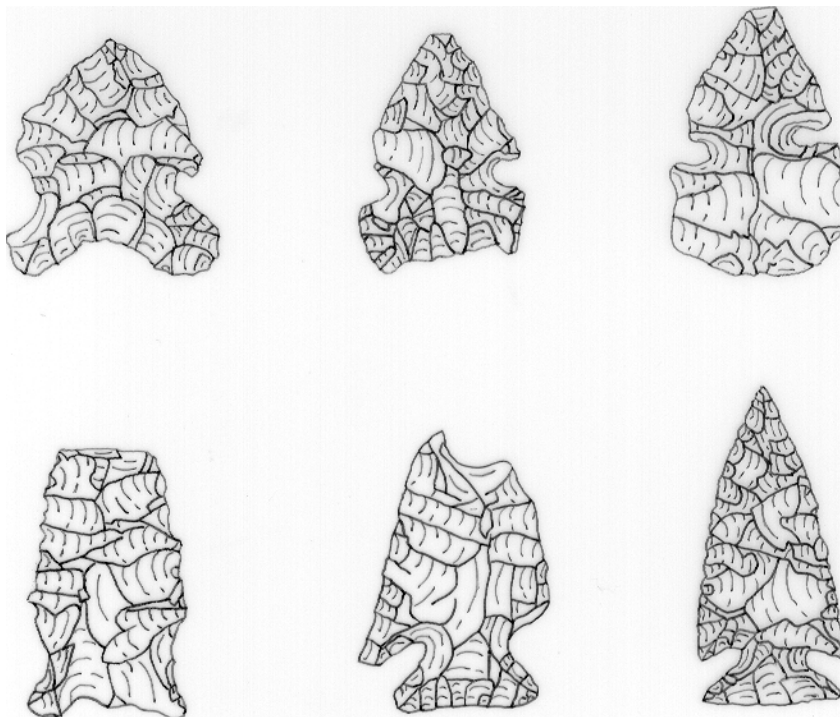

Figure 10.5. Examples of Archaic projectile point types. Top, l-r: Elko Eared (Type 16), Sudden Side-notched (Type 18), and Rocker Side-notched (Type 17). Bottom, l-r: Bajada/Pinto Archaic Stemmed (Type 19), and 2 Elko Corner-notched (Type 15).

Chapter 11

Flotation Sample Processing

This chapter describes the procedure we use to process flotation samples. Flotation samples are samples of sediment containing both organic debris (primarily burned vegetal remains) and inorganic materials (stones, including small artifacts), which, once freed from the matrix, can be subjected to a variety of analyses. The procedure we use to process flotation samples involves mixing the sample with water to separate the constituent elements. The vegetal materials float to the top of the water and are called the “light fraction”; the heavier stones, pebbles, and sand grains sink to the bottom and are called the “heavy fraction.” The sediment itself is largely washed away during the procedure.

We process flotation samples for three reasons. First, flotation separates plant remains from other constituents of a sample, thus facilitating archaeobotanical analysis. This analysis is performed by specialists and is not considered in this manual; however, a detailed description of the methods used is available at www.crowcanyon.org/plantmethods (Adams 2004*1). Second, by removing the sediment, we can better examine the heavy fraction for small artifacts that are not routinely caught in the ¼-inch mesh used to screen sediments in the field. (See Ortman [2003*1: par. 135– 142] for an example of a study that uses artifact data from the heavy fractions of flotation samples.) Third, by removing the sediment, flotation reduces the volume and weight of material that must be curated, thus saving on curation space and cost.

On the following pages we describe and illustrate our flotation procedures, which are performed by staff, interns, volunteers, and participants of middle-school age and older.

Step 1: Gather Flotation Equipment

The flotation equipment used in our lab is simple and inexpensive, and most of the materials needed to make it may be found in any hardware store or fabric store (Figures 11.1 and 11.2):

- 1-gallon bucket
- rubber spatula
- sink-fitting screen and a drying screen, both with $\frac{1}{4}$ -inch mesh
- pieces of fine meshed wedding veil material (0.355-mm) cut to fit the screen
- binder clips
- graduated cylinder (1 liter)
- newspaper
- 10-20 clothespins and clothesline

Other materials include those necessary for paperwork, documentation, and curation (archival polyethylene bags, twist ties, Field Specimen (FS) Form, FS labels, etc.).



Figure 11.1. Flotation equipment. *Left to right:* 0.355-mm mesh wedding veil, a bucket, a graduated cylinder, binder clips, a spatula, and a sink-fitting screen with $\frac{1}{4}$ -inch hardware mesh.



Figure 11.2. Drying screen (with $\frac{1}{4}$ -inch hardware mesh).

Step 2: Measure the Sample

First, get a flotation sample, which will still be in its original field bag (Figure 11.3), and confirm that it has been cleared for processing. A cleared sample will have the letters “CL” written in red ink on the bag label (see Chapter 13). Find the FS form for the provenience designation (PD) listed on the bag, and then open the bag (Figure 11.4) and carefully pour its contents into a graduated cylinder of 1000 milliliters (ml) in volume (Figure 11.5). If the sediments are very fine, you may want to do this outside or in a well-ventilated area.

The field archaeologists generally collect flotation samples of approximately 1000 ml. However, this is not always the case. If a feature such as a hearth is being sampled, the flotation sample may be very large. In this step you should subdivide large samples into as many 1000 ml samples as are possible and give each one a unique FS number (see Step 3). Pass the remainder through a ¼-inch screen, and catalog any artifacts found following the procedures described in Chapter 3. If the sample sent in from the field is less than 1000 ml, measure and catalog the entire sample. After measuring the sample pour the contents into an appropriately sized polyethylene bag (Figure 11.6).



Figure 11.3. Flotation sample as packaged in the field.



Figure 11.4. Opening the flotation sample bag.



Figure 11.5. Pouring the flotation sample into a graduated cylinder.



Figure 11.6. Pouring a measured flotation sample into a polyethylene bag.

Step 3: Cataloging the Sample (page 1 of 2)

Documentation of a flotation sample begins with its entry on the FS Form for the PD from which it was collected (Figure 11.7). Although the same cataloging process described in Chapter 3 is followed here, there are a few details specific to flotation samples. First, as mentioned in Step 2, no cataloged flotation sample should measure more than 1000 ml. If the sample from the field is larger than 1000 ml, it should be divided into as many 1000 ml samples as are possible, and each one given a distinct FS number. If a flotation sample from the field measures less than 1000 ml, the entire sample is kept and the volume recorded in the comments field on the FS Form. Second, the first six columns of the FS Form, plus the comments column, are filled out (the volume of the sample should be entered as a comment). Keep the field bag and the FS Form handy, as you will need both in the next step.

Figure 11.7. How to fill out the FS Form for a flotation sample.

FS	PL	Artifact Category	Bag Date	FS Date	Lab Sup	Cond	Mat	Count	Wt	Comments	Data Entry
4	—	FLO	7/20/03	2/7/04	JDT					1000 ml	Initials _____
											Initials _____
											Initials _____

Fill out these columns (the artifact category code "FLO" stands for "flotation sample").

Record the volume in the Comments column (usually "1000 ml").

See next page for more "paperwork."

Step 3: Cataloging the Sample (page 2 of 2)

Now that the FS Form has been filled out, you should fill out FS labels for the samples you have cataloged (Figures 11.8 and 11.9) (see Chapter 3 for more information on filling out FS labels). Initially, one label is filled out. In addition to writing in all the provenience data from the FS form and the field bag, you must also specify the contents and volume on the label. The contents line should read “Flotation—light fraction” in reference to the light fraction portion of the sample. The volume is recorded on the weight line. In anticipation of a later step in the process, fill out another tag that is identical to the light fraction label, but designate this one “Flotation—heavy fraction.” Set both labels aside.

SITE: 5MT123	DE date _____	Date _____ Analyst _____
PD 1261	FS 4 PL ---	
STUDY UNIT STR 117		
HOR. 1x1 N101/ E101	VERT. SR00-1	
FEATURE 1 Hearth		
HOR. Segment 1 VERT. Full cut		
BAG DATE 7/20/03	FIELD SUP CAS	
CONTENTS Flotation --- light fraction		
Count ----	Weight 1000 ml	

Figure 11.8. FS label for the light fraction of a flotation sample.



Figure 11.9. Lab intern filling out an FS label for a flotation sample.

Step 4: Set Up the Equipment



Figure 11.10. Using binder clips to attach the mesh to the sink-fitting screen.

Place the screen over the sink. Clip the 0.355-mm mesh onto the screen in such a way that it will catch materials as water is poured through it (Figure 11.10). Position the bucket in the sink under the tap. Have a staff member help you with this procedure if you have questions.

Step 5: Flotation



Figure 11.11. Pouring the sample into the bucket.

1. After setting up the flotation equipment, pour the contents of the sample bag into the bucket (Figure 11.11).



Figure 11.12. Adding water and stirring the sample.

2. Begin filling up the bucket with tap water. As the bucket fills, slowly stir the contents (Figure 11.12). This will agitate the sample and encourage organic materials to float to the surface. If you feel “lumps” in the bucket, make sure that you “stir them out” much as you would when mixing cake batter, rather than mashing them! This will ensure that all the organic material (the light fraction) has an opportunity to float to the surface.



Figure 11.13. Sample in the water-filled bucket.

3. Turn off the tap after the bucket is about three-quarters full of water. Let the water sit for about one minute (Figure 11.13).



Figure 11.14. Pouring the light fraction.

4. Carefully pour the water, including the floating material, into the center of the mesh (Figure 11.14). However, **STOP POURING just before reaching the sediment-rich slurry at the bottom of the bucket** (which contains the heavy fraction). Now, repeat the process illustrated on this page **four** more times. With each pour, you should notice smaller amounts of organic material being caught by the mesh.

Step 6: Dry the Light Fraction

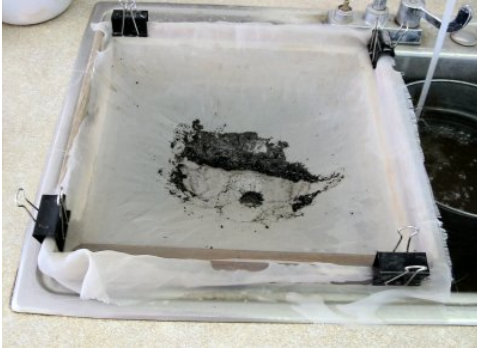

Figure 11.15. Light fraction in 0.355-mm mesh.

1. After the fifth pour of the light fraction into the 0.355-mm mesh, you may want to gently pour some water around the edges of the screen to “chase” the organic material into the center of the mesh (Figure 11.15). This will help prepare the sample for drying. This will also help rid the sample of any fine sediments that were inadvertently poured into the mesh.



Figure 11.16. Twist-tying the light fraction in the mesh.

2. Undo the binder clips that attach the mesh to the screen. Gather up the four corners of the mesh so that the sample bunches up in the center and hangs down in a small bundle. Twist tie this bundle to secure the sample (Figure 11.16).



Figure 11.17. Hanging the light fraction to dry.

3. Put the FS label for the light fraction into a small archival bag. Using a binder clip, clothespin, or something similar, clamp the label and the mesh bundle together and then hang the light fraction to dry on a clothes line set up in a convenient location (Figure 11.17).

Step 7: Dry the Heavy Fraction

Line the bottom of a drying screen with a few sheets of newspaper. Turn now to the contents of the bucket. There should be a layer of sludge at the bottom of the bucket; this material is the heavy fraction. Using a spatula, scrape the bucket's contents onto the newspaper (Figure 11.18). Put the FS label for the heavy fraction into a small archival bag, and slip the bag under the newspaper so that the provenience information for of the specimen isn't lost (Figure 11.19). Then place the tray containing the heavy fraction on one of the shelves in the drying rack.

Any artifacts your notice in the heavy or light fraction should be left in the sample unless the lab supervisor feels that they should be removed from the sample and cataloged separately (see Chapter 3). If any artifacts are cataloged separately from the flotation sample, be sure to note that they were found in a flotation sample and reference the FS number of that sample in the comments box on the FS form.

Thoroughly rinse the bucket and spatula before using them to process another sample. This will ensure that no cross-sample contamination occurs.



Figure 11.18. Scooping the heavy fraction onto a newspaper-lined tray to dry.



Figure 11.19. Placing the FS label under the heavy fraction.

Step 8: Bag the Light and Heavy Fractions

The processed samples may take several days to dry. It is important that the samples be completely dry before they are bagged, because any residual moisture may encourage mold growth.

Once the light fraction is dry, simply dump the contents of the mesh bundle onto a clean sheet of paper (Figure 11.20). The sample may then be funneled into an archival polyethylene bag of appropriate size (Figure 11.21). Slip the FS label, which should already be inside a protective bag, inside the sample bag, facing outward so it can be read from the outside. Putting the label inside its own protective bag helps prevent charcoal smears which might obscure the writing. Twist-tie the sample bag shut.

For the heavy fraction, use the newspaper itself to funnel the sample into an appropriately sized archival bag (Figure 11.22). Slip the previously bagged FS label into the sample bag, and twist-tie the bag shut.

Both samples are now ready for additional analysis (Figure 11.23).



Figure 11.20. Pouring the dried light fraction onto a sheet of paper.



Figure 11.21. Bagging the dried light fraction.



Figure 11.22. Bagging the dried heavy fraction.



Figure 11.23. Bagged flotation samples (light fractions on the left, heavy fractions on the right).

Chapter 12

Preparation of Collections for Curation

After the completion of fieldwork on an archaeological project, much remains to be done in the laboratory. In previous chapters, we have described the ways we process artifacts and samples in our lab. One of the last steps in this process is preparing the collection from each project for permanent curation at a museum or other curation facility. The term “collection” in this context includes the following: (1) all the artifacts and samples (except tree-ring samples) collected from a site; (2) all the paper forms, maps, and photographs that were generated during fieldwork; (3) all the lab forms filled out during processing of the artifacts and samples, including cataloging and analysis records; (4) all the electronic data generated as a result of cataloging and analysis; and (5) major reports and papers written by research staff members using information generated by the project. Preparing the artifacts and samples for curation involves organizing them; replacing the handwritten field specimen (FS) labels with final, printed labels; repackaging the artifacts (if necessary); organizing the curated items in boxes; and creating the final box inventories. The paper records must be gathered, organized into file folders, and inventoried. In addition, the electronic data (field and lab records that have been entered into the computer database) are also curated. Essentially, everything pertaining to the excavation of the site, from the field to the lab, is organized, packaged, labeled, and inventoried before being transferred to the curation facility.

Curation of collections resulting from archaeological fieldwork is considered so important that it is one of the stipulations of federal and state permits, which are required for any persons or institutions who conduct any kind of archaeological fieldwork on public lands. Included in any permit is a written requirement that all the artifacts and samples, as well as all field and lab records, be turned over to a recognized curation facility that will store the collection in perpetuity and maintain its organization to facilitate future study. Therefore, before fieldwork can begin, an agreement is drawn up with a recognized curation facility to accept the collection by a specified date.

Every curation facility has guidelines that detail how a collection should be packaged, organized, and documented. Our local curation facility, the Anasazi Heritage Center (AHC) in Dolores, Colorado, has a policy document called “Requirements for Collection Organization, Packaging and Delivery”. This document specifies the type of bags that should be used for artifact and sample packaging, the kind and size of boxes that should be used for artifact and document storage, the kind of paper that labels and forms should be printed on, how a collection should be organized, and so forth. The document also details the kinds of processing techniques that are and are not acceptable, and it lists various items that the AHC does not accept for curation. Curation fees, which are based on the ownership status of the land on which the site is located and on the number of boxes in the collection, are also defined in this document.

Preparing a collection for curation is a time-consuming process that is best begun after all the

fieldwork, lab analyses, and data entry and editing have been completed. The report-writing phase of an excavation project should also be completed, because the field and lab records for a site are repeatedly consulted during this process, resulting in additional changes to forms, documents, maps, photographs, and even artifact labels.

The first step in the curation process is to gather all the artifacts from and documents for the site and compile any information that could affect the way in which the collection is to be curated. This requires communicating with all researchers and publications staff who have been involved in the fieldwork, analysis, and/or report writing. They should be informed that the curation process is about to begin and asked to return any site documents or artifacts that they may have borrowed from the lab. In addition, they should be asked if any additional work will be undertaken with the artifacts, samples, or records, or if they anticipate any further changes to the maps or any other data set. Since additional work might affect the collection, the lab needs to know what work is being done, when it will be completed, and what parts of the collection will be affected. This information is needed before the work plan for the curation process is prepared. Once the curation process begins, no further changes to the forms or artifact data are allowed.

Setting up a Curation File

It is helpful at this early stage to set aside an area of the lab for temporary storage of any files, notes, and supplies that are needed for the curation process. Four files should also be established at this time. These are described below.

1. *Receiving File.* Most curation facilities provide a collections-receiving form, which is filled out as a collection is prepared for curation and which must accompany the materials when they are accessioned. The form used by the AHC is called the “Archeological Project Summary/Collection Receiving Form.” This form provides space for a description of the project and for a list of the items being transferred (types of artifacts, samples, and site documents). Researchers should become familiar with the receiving form and be aware of any special curation requirements before beginning fieldwork and lab processing. A copy of the form should be made and kept in a “receiving file” as one begins to organize the collection for transfer.
2. *Clearing File.* A “clearing file” should also be started to keep track of the many management aspects of curation. This file should contain documents that pertain specifically to the management, location, and history of the collection. Thus, the clearing file can include loan forms; records that document changes made in the artifact or provenience data; lists of artifacts or samples that underwent destructive analysis; lists of artifacts and samples that were used in displays; notes about artifacts, samples, forms, or photos that are missing, damaged, or destroyed; lists of problems that still need to be resolved; and lists of bag changes that were requested by field or lab personnel. Two information sources used to compile the clearing files are described below:
 - *Loan forms* are generally kept in a collection’s clearing file. These forms should be reviewed to be sure that any collections that were sent out for analysis were returned,

along with(1) the resultant data, (2) descriptions of analytical procedures and protocols, and (3) an interpretative report, if such a report was requested. If any loaned materials have not been returned, the original borrower must be contacted about the status of the analysis, and it should be determined when the items will be returned and the analysis information submitted. The date that loaned materials are returned should be entered into the FS data table (e.g., “returned as of 5/5/03”), and a new printout should be run that provides the latest information.

- Other information pertinent to a collection’s clearing file may be found in Crow Canyon’s *research database*, particularly in the *FS data-management form*. For example, check boxes are provided in the FS data file so that one can flag items that underwent destructive analysis, artifacts that are on display, artifacts that are missing, artifacts that were not collected, and artifacts that were “voided”. Next to each check box there is a comments field where one describes the condition of the artifact or the status of the analysis. When setting up the clearing file for a collection, computer printouts should be generated for each of the situations described above. Each printout should include the site number, the provenience designation (PD) and FS numbers, the artifact category, and the comments. These lists should then be consulted as the collection is being organized and prepared. They may help lab personnel locate artifacts or otherwise solve problems that are identified during the curation process. They may also need to be edited as missing items are found, items are removed from display, loaned samples and artifacts are returned, and so on. As the curation process continues, the lab staff should refer to the clearing file frequently to remain familiar with the problems and issues that could affect the collection.

3. *Methodology File*. A “methodology file” should be set up for forms or other documents that are relevant to how the artifacts and samples were collected, processed, and analyzed. This file should include copies of the forms and codes used in the lab, as well as documentation about analysis procedures (the AHC maintains these files for all Crow Canyon field projects). Be sure to include documentation of any departures from standard field and lab procedures or of changes to previous systems (for example, new or updated analysis forms, codes, and protocol; documentation of new field strategies or processing techniques).

4. *Curation Checklist*. Finally, a “curation checklist” should be created to list the tasks that have to be completed as part of the curation process. It might be helpful to have deadlines indicated as well. As noted above, preparing a collection for curation can take a long time and is often done by many different people; therefore, a checklist can help ensure that all the steps involved are dealt with in a timely manner and none is overlooked.

Final Datachecks and Initial Organization

After establishing the files necessary for tracking the curation process, we turn to the collection

itself. Before preparing the artifacts, we perform a datacheck to ensure that all the data have been entered, edited, and cross-checked. Each data set should be checked to be sure all the data have been entered. This is accomplished by a quick review of the analysis sheets and the research database. Every recording sheet and label we use includes a space in which the data entry date should be written; there may also be paper printouts or additional notations on the forms and labels to indicate that the data have been edited. These records should also show any corrections that have been made in the database. If any data still need to be entered or edits need to be made, these tasks should be completed before you proceed.

The next step is to organize the artifact and sample collection. Up to this point, some artifacts may still be organized by year of collection. Now, however, the collections from individual field seasons should be integrated into a single sequence. The bags containing samples and artifacts should be organized by artifact category, then by PD number, and finally by FS number. While organizing the bags, look for any FS labels with missing information, labels that are incorrect, or bags that have been filed with the wrong artifact category. When an entire artifact category has been organized, now is the time to resolve any problems that are discovered. To solve the problems, consult the clearing file and check the database to see if there are notes in the file or in the database that might help resolve inconsistencies. When problems are resolved, it should be noted on the problem list and any necessary changes should be made in the database. If a particular problem cannot be resolved at this time, a note about the problem should be made and placed in the clearing file. Some discrepancies may not be resolved until all the artifacts and samples are organized and all the FS labels are replaced (see the following section).

Replacing FS Labels

After the collection is organized, the FS labels in the artifact and sample bags are replaced with new labels. Up to this point, the labels have been the original handwritten labels that were filled out when the contents of the bag were originally cataloged (see Chapters 3 and 11). These original labels should be replaced at this stage with new, printed FS labels generated from the database. The new labels are more readable and have current and accurate information on them that reflect any changes that have been made since cataloging was completed. These final labels are printed on acid-free paper as required by the AHC. The information on the labels includes the site number, PD number, FS number, and artifact category. The computer-generated FS labels also act as an inventory for each artifact category.

To replace the labels, assemble all boxes or flats containing artifacts of a particular artifact category. Then make sure the bags are organized in PD-FS order. Once the artifact bags are in order, start replacing the FS labels. **Remember, the new label must go in the correct bag, or provenience control will be lost for the contents of that bag, or— worse— the provenience of several bags will get mixed up.** To avoid problems, one should compare the site, PD, and FS numbers on the old label to the same numbers on the new one before the old label is removed from the bag. If the labels match, then the old label can be removed and the new label inserted. The original FS labels should be placed face down on the table in PD-FS order. The new label should not be folded and should always be placed in the bag so it can be easily read from the

outside. If possible, place the label so that it is oriented horizontally in the bottom of the bag. If the bag is too small for this, then place the label vertically so it can be read left to right from the bottom of the bag up. The bag can then be fastened with a plastic twist tie (remember to twist only twice!). The artifact bag should be put to the side, in PD-FS order with the other bags. Because the labels and the artifacts are in PD-FS order, it should be easy to proceed through the rest of the collection, replacing old labels with acid-free labels, collecting the original labels in an organized pile, and placing the bags with the new labels in rows that are still in PD-FS number order. The old labels are retained during this process so they can be checked if it becomes necessary to track an error.

During this process, several problems might be encountered. There might be a computer-generated FS label that does not have a matching bag, or there might be a bag without a computer-generated label. Often these problems can be resolved by looking up the PD and FS numbers in the database. The problems are usually related to errors made during cataloging: perhaps the label was filled out incorrectly. To resolve this kind of error, and to confirm the FS number assignment, you might have to find other bags from that PD and consult the database. Problems can also be due to changes made to the FS or PD numbers by the field or lab staff after the original bag label was filled out, these changes should have been recorded in the FS form in the database, in the “Changes” section. If the problem cannot be resolved, it should be noted in “Comments” section of the FS form in the database where the problem should be described as well as the steps taken to address the problem, if possible. Luckily, by the end of the curation process, most errors are resolved.

As the labels are being replaced, you will need to check the packaging of the collection. Bags that are damaged, or that are not of archival quality should be replaced. Twist-ties should also be checked: very short twist-ties and paper ties should be replaced with plastic ties of adequate length. When working with vegetal samples, flotation samples, and other types of sediment samples, be sure to place the label in a small, archival-quality, polyethylene plastic bag inside the sample bag so that the label is not in direct contact with the sample (this is supposed to be done during the cataloging or sample-processing stages — make sure it has). Artifacts and samples should not be stored in film canisters or drug bottles; if these containers have been used, the items should be removed from them and placed in standard polyethylene bags. If any items in the collection are fragile, they should be placed in curation boxes with acid-free tissue and curation-quality foam. The box can then be placed in an archival-quality bag with the label on the outside of the box.

When the labels have been replaced in all bags for a given artifact category, check that the bags are still in PD-FS order. If any bags are out of order, it could indicate an error in ordering the bags and/or labels before or after replacing the labels. The most serious problems, of course, are ones resulting from placing the wrong label in a bag. If the bag contains analyzed pottery or chipped-stone, it is possible to cross-check the new computer-generated FS label against the original handwritten analysis label. Otherwise, you will have to rely on the weights of the artifacts and/or the order of the replaced handwritten labels to resolve the problem.

Boxing the Collection

Once all problems have been resolved, the artifacts can be placed in archival storage boxes. Be sure to use the correct type and size of box — curation facilities often have specific, but varying, box requirements. The artifacts are organized in the box in a specific order. The bag with the lowest PD-FS number combination is placed in the bottom front on the left side of the box; the others bags follow toward the back. If there is enough space, another row should be started in the front of the box on the right side and filled in to the back of the box. When the bottom of the box is full, place a square of archival quality plastic (this can be a large plastic bag or a sheet of plastic) on top of the artifacts and begin another row of artifacts, starting at the left front again and proceeding to the back. If the artifacts and samples are small and light, there can be as many as three layers in a box. If the artifacts are heavy, the box should not be filled to capacity. The weight of the filled box should not exceed what an average person can lift over his or her head. When the box is full, put a label on the outside of the box. At this point, the label can be a simple note that is taped onto the box. The label should have the following information: site number, artifact category and the PD and FS number of the first bag in the box and the PD and FS number of the last bag in the box. Permanent labels will be placed on the boxes when the entire collection is completely boxed and organized and the box numbers are assigned. The following important information is written on the permanent box labels: the site number and name, the box contents (artifact category), the range of PD-FS numbers encompassed by the artifacts in the box, and the box number out of the total number of boxes in the collection (Figure 13.1). Very large artifacts, such as metates, are often too large to be placed in a curation box. Such artifacts are placed inside a large polyethylene bag with the FS label visible inside the bag.

Although the order in which the boxes are organized and numbered is not critical, we prefer to begin with samples; we then move on to bulk artifacts and finish with boxes of individual artifacts. The artifacts and samples within those three major divisions are organized in alphabetical order by category (see Chapter 4 for category lists). The oversize artifacts are listed at the end of the log with a note that indicates that they are oversize.

Once the artifacts and samples have been boxed, the database is used to produce a complete inventory of each box (Figure 13.2). The inventory lists each artifact in the box in PD-FS order and includes some of the basic information that was recorded about each artifact. Two copies of each box inventory should be made. Place one copy in the top of the box it inventories. Place the second copy in box number order with the other box inventories for the site and file the complete set with the lab forms. Next create a box inventory log either by hand or by computer that lists the site number, the box number, the artifact category, and the PD-FS range in each box. This log is filed with the complete set of box inventories, and a copy is kept in Crow Canyon's files.

Review of the Clearing File

At this point, the clearing file (that is, the list of missing artifacts, artifacts that were subjected to destructive analysis, artifacts still on loan, artifacts not collected, etc.) should be looked over one more time. Most problems identified during previous steps of the curation process should have

been resolved by now, but any remaining problems or inconsistencies should be resolved or documented as unresolved at this time. The information in the database should now be complete, accurate, and up to date. If any changes to the data are made after this stage, new lists should be run; changes should not be handwritten on the existing printouts. A file folder containing these final clearing lists should be placed in the lab records file.

Curation of Documents and Records

All documents related to an archaeological project must be curated. These include forms filled out by the field and lab staffs, photographs, maps, administrative records, and major reports and papers written by Crow Canyon staff about the site (or that use site data). The forms are placed in acid-free file folders labeled with an archival pen as follows: Crow Canyon Archaeological Center, the site name and number, the project name, and the contents of the file. The files are placed in archival-quality document boxes in a specific order: The administrative records are placed at the beginning of the file box, followed by field records and maps, lab forms, photographs, and copies of reports, publications and papers. Electronic data are also curated. These include all field data that have been entered into the database, the FS data and the analysis data. Oversize maps are placed in a large, cardboard folder that is labeled similarly to the files. The various types of files are further described in the following paragraphs.

The *administrative records* include all documents and correspondence related to Crow Canyon's work at a given site. These records include permits issued from the state and/or federal governments that granted us permission to perform the fieldwork. There should also be copies of agreements with curation facilities for the storage of collections and records from the site. If work was done on private property, any agreements made with private landowners should be included in the file as well. There should also be signed donation forms, which deed any artifacts found on private property to the curation facility.

The *field records* for a site are organized in folders, one or more for each study unit, depending on how many subdivisions of the study unit there are and how much documentation exists for each (for more information on Crow Canyon field forms, see the online field manual at www.crowcanyon.org/fieldmanual). The folders are ordered by study unit number. If there are numerous horizontal subdivisions in a study unit a folder may be made for each subdivision and they should be organized by the horizontal subdivisions. In this case the first folder should contain the study unit log and it should be labeled with the site number, study unit type and study unit number and the words "Study Unit Log." Inside the folder for a given study unit, the following records should be filed, as applicable: the study unit log; study unit maps (not oversize); point-location (PL) logs; the feature log; feature forms (with feature maps and PL logs), organized by feature number; masonry forms; profile maps (not oversize); stratigraphy forms; and PD forms, ordered by PD number. Sometimes there are so many PD forms that they need to be placed in their own folder behind the associated study unit folder. If it is necessary to create a separate PD folder, it should be labeled with the site number, study unit type and study unit number, horizontal subdivision (if necessary), and the words "Provenience Designation (PD) Forms." Some field documentation describes or pertains to the site as a whole, rather than

to an individual study unit, these papers are filed in folders at the beginning of the field records. A complete set of copies of the original field forms is generally archived at the Crow Canyon Archaeological Center.

Lab forms document a wide variety of data. Records that deal with the collection as a whole are placed at the beginning of the lab forms section. The box inventory log and the box inventories are filed next. The next two files contain the field inventory forms, organized by date, and the FS forms, organized by PD number. The analysis forms come next (see the preceding chapters of this manual for examples of these forms). For each type of analysis there should be a folder that includes a blank analysis sheet, a coding sheet, and a document that describes the analysis procedure and protocol. The next file folder contains the analysis forms, organized by PD number and then by FS number. The forms for standard pottery analysis are followed by those used for more-specialized pottery analyses, such as vessel, rim-arc and temper studies. The forms for basic chipped-stone analysis are next, followed by the forms for more-specialized analysis of selected chipped-stone tools — for example, bifaces, drills, and projectile points. The analysis forms for samples are next. Archaeobotanical (vegetal), pollen, and tree-ring analysis forms are followed by forms for any other sample analyses. Any analysis that is performed by outside specialists should have a file that contains the original forms, blank analysis sheets, protocol and procedural information, and the final report written by the specialist, if such a report was requested. All of the original analysis forms are curated. Because these data are maintained in our database, Crow Canyon does not keep copies of lab forms except for those generated by outside specialists (for example, pollen, tree-ring, human remains, and obsidian-sourcing reporting forms).

Field and lab photographs are organized by film type (color slide or black-and-white contact sheets) and then by roll number. The color slides, contact sheets, and negatives are placed in archival-quality photo pages. Each slide is labeled with the site, roll, and exposure numbers. Each slide page is labeled with the name of the institution (Crow Canyon) and with the site number, roll number, year, and page number. The associated field photo log is filed in front of the photographs and negatives. The photographs are then filed in archival-quality folders. If photographs of more than one site are on the roll, only those of the site whose collection are currently being prepared for curation are included. The remainder are removed and placed in another slide page for future curation.

Field maps are usually filed with the field forms for the appropriate study unit. If the maps are larger than 8½ x 11 inches, they are considered oversize. The oversize maps must not be folded or rolled. Instead, they are organized by map number and placed flat in a temporary cardboard map folder. The map folder is labeled “Crow Canyon Archaeological Center, site number, Oversized maps, folder _ of _.” When the folder is turned over to the AHC, the maps are removed and placed in a flat-file cabinet for permanent curation.

Reports, publications, and papers that are written about the site, or that use data generated as a result of our work at the site, should be copied and put in the file. Reports can be added to the file at any time until the collection is delivered to the AHC. The AHC requests that two copies of

a project's final published report be included in the submission. To be sure that all reports are gathered, we ask all the people who worked on the site or on the analyses if they know of any other reports or documents that need to be included in the report section.

As the end of the curation process approaches, we contact the curation facility and schedule a date of transfer. Some facilities want several months of lead time to prepare for the transfer, and they want a count or estimate of the number of boxes that are in the collection. The final tasks are to complete the curation facility's collection-receiving form, to resolve any remaining problems or questions and to create the final lists of artifacts, samples, that are missing, destroyed, or oversize. These final lists concerning the artifacts are stored in file folders at the beginning of the lab records section. The collection-receiving form is given to the curator of the curation facility when the collection is delivered. When these tasks are done, the boxes can be transferred to the curation facility.



SITE NUMBER and NAME:

CONTENTS:

**CROW CANYON
ARCHAEOLOGICAL
CENTER**

PD _____ FS _____ THROUGH PD _____ FS _____

BOX _____ OF _____

Figure 13.1. Curation box label.

Crow Canyon Archaeological Center Yellowjacket Pueblo 5MT5 Inventory for Box 110
Slab Metate (SME): PD 46 FS 4 through PD 434 FS 8

PD	FS	PL	Artifact Category	Ware	Study Unit Type	Study Unit #	SU Horiz	SU ID	SU North	SU East	SU Vertical	Vert No	Vert. Sub No	Feature Type	Fea. No	Fea Hor	Fea. North	Fea. East	Fea. Vert	Fea. Horiz	
35	23		SME		STR	704	1x1		1149.00	1013.00	STLV	2	1								
46	4		SME		ARB	600	2x1		1139.00	1004.00	STRA	2									
69	10		SME		NST	604	1x1		1106.00	1003.00	STLV	2	1								
140	6	1	SME		STR	1207	SEG	1			STRA	2									
140	11		SME		STR	1207	SEG	1			STRA	2									
147	4		SME		STR	1204	SEG	1			STRA	3									
157	3		SME		STR	1210	SEG	1			STLV	2	1								
172	2		SME		ARB	1200	SEG	1			STRA	1									
181	4		SME		STR	1209	SEG	1			STRA	3									
212	1		SME		NST	1003	1x1		1256.00	1073.00	STRA	1									
213	11		SME		ARB	1100	2x1		1282.00	1094.00	STRA	2									
214	3	1	SME		ARB	1000	2x1		1269.00	1059.00	STRA	2									
217	2		SME		NST	1003	1x1		1256.00	1073.00	STRA	2									
286	6		SME		STR	704	1x1		1149.00	1013.00	STRA	4									
333	9		SME		ARB	200	2x1		973.00	992.00	STRA	1									
396	4		SME		ARB	2500	2x1		904.00	866.00	STRA	1									
433	5		SME		ARB	200	2x1		973.00	992.00	STRA	2									
433	12		SME		ARB	200	2x1		973.00	992.00	STRA	2									
434	7		SME		ARB	100	2x1		937.00	965.00	STRA	2									
434	8		SME		ARB	100	2x1		937.00	965.00	STRA	2									

Wednesday, April 14, 2004
Page 1 of 1

Figure 13.2. Example of a Box Inventory.

Chapter 13

Quality-Control Procedures

This chapter describes the procedures we use in the Crow Canyon laboratory to ensure the integrity of all systems and products related to the analysis and management of our collections. Standardized procedures for monitoring the quality of our data are essential because so many people of varied abilities and from different backgrounds work with the materials in our lab. The quality-control measures we have implemented are designed to address several basic goals that are key to the successful operation of any archaeological laboratory. The first is simply the organization and tracking of artifacts and samples, so we can ensure that they are processed, cataloged, and analyzed in accordance with institutional standards. The second is the identification and correction of errors made during recording and data entry, to ensure that the labels in bags of analyzed materials correspond exactly to lines of data in the database. The third is the verification of the actual analysis data, to ensure that observations are made and recorded consistently within and between projects. In this chapter, the procedures we have developed to accomplish these goals are presented in the order in which they occur, from the time materials are first brought into the lab until the completion of in-house analyses (see Figure 2.1 in Chapter 2). Explanations of how the various procedures promote both efficiency of operation and accuracy of the resultant data are offered throughout.

Field Inventory and Check-In

One of the basic tasks of any archaeological laboratory is to house, organize, and keep track of artifacts and samples until they are turned over to an appropriate facility for permanent curation. At sites excavated by Crow Canyon, pottery and stone artifacts of all types from each Provenience Designation (PD) are combined in one or more field bags on which provenience information is recorded. In contrast, samples such as nonhuman bone, vegetal samples, flotation samples, and tree-ring samples are bagged separately by type. When materials are brought into the lab, they are accompanied by a field inventory that has been filled out by the field crew. This inventory lists the collection date, site number, PD number, and contents of each bag. The lab staff checks the bags against the field inventory. If there are bags that are not on the inventory or bags that do not match the inventory, the problem bags and the inventory are sent back to the field crew for correction. If there are no problems with the inventory, or when all discrepancies have been resolved, the inventory is filed with the field forms. The field inventories thus provide our first record of the artifacts and samples that have come into the lab.

After the artifacts and samples are checked against the field inventory, the bags are organized by PD number. From one PD there are usually several bags containing artifacts and several smaller bags that contain nonhuman bone, adobe samples, and vegetal samples. The small bags are placed inside the larger artifact bag to ensure that the artifacts and samples of the same PD remain together. The bags are then placed in boxes on the wash lab shelves in PD number order. The boxes are labeled “Artifacts: not cleared, not screened, not washed.” Flotation samples and tree-ring samples are stored separately from other artifacts because they are processed separately

and are often large and awkward.

Checking Field Forms and “Clearing”

The field crew fills out a variety of forms that describe each excavated unit and the deposits and features found within it (Crow Canyon Archaeological Center 2001*1). The field crew assigns a unique PD number to each distinct horizontal and vertical space that is excavated and/or from which materials are collected. A PD log is filled out in the field that lists each PD number and specifies the horizontal and vertical space it refers to. The field crew also fills out a PD Form for every provenience investigated. This form includes space for the field crew to record the location of the PD and to describe the sediment, inclusions, and any other salient observations. The field crew also draws maps and fills out forms that illustrate and describe architectural features, masonry, and stratigraphy. All of these forms are turned into the lab when the excavation of a unit is complete.

Before clearing artifacts for processing, the lab checks the original field forms for consistency and accuracy. If any errors or inconsistencies are found, the forms and/or maps are sent back to the field crew for clarification or correction. We need to be sure that the PD information is correct because we copy this information onto paper labels numerous times as the artifacts in a field bag are processed and analyzed. In the course of cataloging and analyzing the contents of an artifact bag, we could transfer the PD number written on the original field bag to more than 50 labels. If we were to discover partway through or at the end of processing that this number was incorrect, we would have to find the bags with incorrect labels, change the PD number on all the incorrect labels, and file the corrected bags according to their new PD order - a lot of extra work!

Once the PD forms have been checked, and any problems resolved, the PD data are entered into our research database, and a Field Specimen (FS) Form is printed for each newly entered PD (see Figure 3.2 for an example of an FS Form). The FS Form will be filled out when the artifacts from that PD are cataloged. At the top of the form is the PD number and the provenience information associated with that number.

The next step in the process is to “clear” the artifact and sample bags that are labeled with verified PD numbers. The lab staff takes an FS Form and retrieves the field bags with the same PD number from the boxes of “Artifacts: not cleared, not screened, not washed.” When the bags are found, the provenience data on the bag are compared with the corresponding data on the FS Form. If the provenience data on the bag match those on the form then a large “CL” is written on the top of the bag with a red pen, and the bag is placed in a new box labeled “Artifacts: cleared, not screened, not washed.” The bags in this box are always kept in order by PD number.

Size-Sorting and Washing

Once the artifact and sample bags have been cleared, they are ready to be washed or otherwise processed. The specific procedures followed for special samples depend on the type of sample in question. For example, tree-ring samples are assigned FS numbers and packaged for shipment to

the Laboratory of Tree-Ring Research at the University of Arizona for analysis, and flotation samples are prepared for archaeobotanical analysis following the procedures discussed in Chapter 11. The next steps in processing cleared bags of artifacts, nonhuman bone, and vegetal material are described below.

First, all bags of artifacts, nonhuman bone, and vegetal material from a PD are removed from the boxes, and the contents of each artifact bag in turn are dumped into a pair of nested screens placed over a garbage can. The screen on the bottom has ¼-inch mesh (the same size used in the field), and the screen on top has ½-inch mesh. As the artifacts are screened, any nonhuman bone or vegetal material observed in either screen is removed and put in an existing bag from that PD containing the same material. If no bag for this material yet exists, then one is made and the information from the original bag label is copied onto the new bag label. The pottery and stone artifacts that fall through the ½-inch mesh but are caught in the ¼-inch mesh are placed in a new paper bag labeled with the same information as appears on the original field bag, with the exception that the contents of this new bag are described as “Small Artifacts.” The artifacts caught by the ½-inch screen are placed back in the original bag, and the description of the contents on this bag is changed to “Large Artifacts.” All other bags, including the newly created small-artifacts bag and any existing vegetal sample and nonhuman bone bags, are placed inside the large-artifacts bag. Then the large-artifacts bag, with the other bags nested inside, is placed in a box labeled “Artifacts: cleared, screened, not washed.” As more large-artifacts bags are added to the box, they are arranged in order by PD number.

When it is time to wash the artifacts, a large-artifacts bag is removed from one of the boxes labeled “Artifacts: cleared, screened, not washed,” and the small bags nested inside it (small artifacts, vegetal samples, and nonhuman bone) are placed to the side. The “large artifacts” in the bag are emptied into a shallow tray in a lab sink, and are gently scrubbed in plain, cool water with a toothbrush. The items are placed on a tray that has a fine wire mesh for its base. The original artifact bag that the artifacts came out of is placed in the tray with the artifacts and the tray is placed in a drying rack. A new tray is used for the “small artifacts,” these artifacts are placed in a tray in the bottom of the sink and sprayed with water. The original bag is placed on the tray and the tray is placed in a drying rack. Vegetal samples are not washed, but they should be kept with the other artifacts that have been washed from the same PD, the bag should be placed in the drying racks with the nonhuman bone or other artifacts from that PD. Nonhuman bone samples are not submerged in water but are gently brushed with a wet, soft toothbrush and then placed on a tray with a screen base. If there are bone fragments that are very small they should be placed on a paper towel in the tray so they can’t fall through the mesh. The original bag should always be kept in the tray with the washed artifacts and when the artifact trays are placed on the drying rack. Once all the washed items are dry, the large artifacts are put back in the large-artifacts bag. The small artifacts and nonhuman bones are returned to their respective bags and are once again nested, along with the vegetal samples (which were never removed from their bag), inside the large-artifacts bag. The artifacts and other materials are then ready to be cataloged (see Chapter 3).

There are two reasons why we follow this somewhat complex procedure for organizing, size-

sorting and processing artifacts in the wash lab. First, although it is important to place nonhuman bone and vegetal samples in separate bags in the field to protect them from being crushed under the weight of pottery and stone, this sort is rarely perfect. That is, we often find nonhuman bone and vegetal material in artifact bags, and we find a few stone or pottery artifacts in bags of nonhuman bone. It is important that we finalize this sort before cataloging to ensure that we assign as few FS numbers as possible for each PD. For example, if a few nonhuman bones were present in a bag of artifacts, and this bag was cataloged separately from the bag of nonhuman bone, we would be forced to assign two FS numbers to nonhuman bone from this provenience, because it would take us much longer to find the previously cataloged bag of nonhuman bone, add the new material to it, and change the associated cataloging sheet and database record. And even this solution generates unnecessary work, because every FS number has a corresponding label that must be handwritten and ultimately replaced by a computer-generated label, as well as corresponding line of data in the database that must be entered and checked. The most efficient solution, overall, is to make sure that these sorts are accurate before cataloging begins and to catalog all material from a given PD at the same time.

Secondly, we size-sort artifacts before cataloging to separate pottery sherds that fall through a ½-inch mesh from larger sherds. We use screens with ¼-inch mesh in the field to make sure we collect small flakes, beads, and animal bones from our excavations. However, we have found that it is rarely possible to classify sherds that fall through ½-inch mesh to a specific type. To increase efficiency in pottery analysis, we catalog sherds that fall through the ½-inch mesh separately from those that are captured by it, and we analyze only the larger sherds. Even though pottery in the “bulk sherds, small” category constitutes only about 10 percent of the pottery in an artifact bag by weight, it can represent 50 percent of these sherds by count. So size-sorting artifacts has the effect of reducing the number of sherds to be washed and analyzed by one-half, while resulting in minimal loss of analysis information. This approach thus saves our staff, interns, volunteers, and participants countless hours of pottery analysis. We size-sort all pottery and stone artifacts before washing because we do not want to spend time scrubbing sherds that we know we will not analyze. Furthermore, it turns out that dirt does not adhere strongly to small stone artifacts. So by spraying the small artifacts instead of washing them individually with toothbrushes, we reduce our washing-labor needs by about one-half. During cataloging (Chapter 3), the small stone artifacts are reintegrated with the larger stone artifacts, but the small sherds are kept separate from the larger sherds and are cataloged as “bulk sherds, small.”

Catalog Data Entry and Edit

Once the artifacts from a field bag have been cataloged, the filled-out FS Form is placed in the pocket at the front of the FS Form notebook until the information recorded on it is entered into the database. As each Field Specimen is entered into the database and saved, the individual doing the data entry should fill out the “data entry” section of the FS Form. This includes the date of entry and the initials of the person doing the data entry.

Once all the FS data for a field project is entered into the database, a printout is made that includes all the data fields on the FS form. The records on this printout are ordered by PD

number and then by FS number. This printout is then scanned for data entry errors by comparing the handwritten FS forms to the printout. Any errors or other problems are noted on the printout using red ink. When this line-by-line comparison is done, all necessary corrections are made to the FS data in the database. As the changes are made, a note is written on the printout to indicate that the indicated changes have been made in database, and the date of completion of these edits is also written. This printout is kept to document that a line-by-line edit has been accomplished for the catalog of the artifacts and samples in the collection.

Organizing Cataloged Artifacts

After the artifacts from a given artifact bag have been cataloged, they are sorted into boxes according to the artifact category written on each FS label. When the entire collection from that field season has been cataloged, the bags within each category are organized in cardboard flats in order by PD and FS numbers. As we organize the bags, we look for labels with missing or incorrect data, labels that are not properly filled out, bags that were placed in the wrong artifact category box after cataloging, and so forth. Such problems are corrected at this time. When we complete our excavations at a site and have finished cataloging the entire collection, we then integrate the materials from the different field seasons in a single set of cardboard flats, again organized by artifact category, PD number and FS number. However, due to time constraints it is not always possible to organize all the artifacts of a given artifact type before the data checks need to be done. If that is the case, the data checks are done by field season and the whole artifact collection might not be organized in one set of cardboard flats until the collection is being prepared for curation.

Organizing bags by site, artifact category, PD, and FS is essential for all subsequent datachecks because it makes it easy for staff members to find specific bags if it becomes necessary to check their contents or the data generated about them. For example, individuals entering FS data might encounter problems with specific records that cannot be resolved at the time of data entry. These problems are written on lists in the FS notebooks. Once the collection has been organized, these problems can be solved efficiently. In addition, we periodically query our database for incomplete records, and we generate printouts that list artifact bags for which certain data are missing or contradictory. Working from these printouts, the staff can find the relevant bags, solve the problems, and correct the data.

Consistency Check

Once the entire collection from a site has been organized by artifact category, PD, and FS, a “consistency check” is done for all artifacts that were assigned to an individual artifact category during cataloging. This check is performed to ensure that individual artifacts have been classified consistently over the course of the project. This is an important check for the following reasons: (1) many different people catalog artifacts over a long period of time, and therefore the potential for inconsistency is significant; (2) most individual artifacts are rare enough that interns, volunteers, and participants do not have an opportunity to apprehend the full range of variation in any particular artifact category; and (3) the ability of interns, volunteers, and participants to

correctly identify fragmentary individual artifacts varies widely.

To accomplish this task, we first generate a printout that lists the PD number, FS number, and associated catalog data for all artifacts of a specific category. In preparation for the consistency check, the staff also reviews Crow Canyon's artifact definitions, the stone material type definitions, and the stone material type collection. During the consistency check, all bags containing artifacts of a given category are examined at the same time by the entire lab staff, or they are examined by a staff member who is in constant communication with the rest of the group. The artifacts in a specific category are compared item-by-item to the printout, and all data on the printout are checked, including the PD number, FS number, artifact category, material type, condition, weight, and comments. As errors are found, the correct information is written on the printout. If the artifact category recorded for a given item needs to be changed, the new artifact-category name is written on the printout and the bag label, and the artifact bag is then placed with other artifacts in the same category. When the consistency check is finished, all changes that were handwritten on the printout are entered into the database. The consistency check allows us to correct errors in identification, fill in missing data, organize the collection, and create a final inventory for each artifact category.

Datachecks: Pottery Analysis

A number of procedures have been established to ensure that the data generated during basic pottery sherd analysis (Chapter 5) are complete, consistent, and accurate. During pottery analysis, each sort performed by a participant and/or a volunteer is checked by a staff member as it occurs. Both the actual sherds in each pile and the analysis label filled out to describe each pile are checked before the sherds are bagged with the label. Staff members also make a point of consulting one another when ambiguous or difficult sherds are encountered, to make sure that all staff maintain a similar understanding of the pottery types we use in our analysis.

Each label filled out during pottery analysis describes the type, form, part, and finish of a group of sherds from a given PD and FS. We enter these data directly from the analysis label so that the person entering the data has a second opportunity to check the contents of the bag against the analysis label and correct any errors. This assures that each analysis label and the associated sherds correspond to a single line of data in our pottery database.

When pottery analysis data are entered into the database, a staff person or intern opens the bag of "bulk sherds, large" for a given PD and FS and removes the smaller bags containing analyzed sherds and analysis labels nested inside. These bags are organized on a table by the computer. Bags with item numbers (see Chapter 5) on their analysis labels are set out in order, and bags without item numbers are organized by pottery type. Then the data on each analysis label are entered into the database. The person entering the data looks for missing, incorrect, and/or inconsistent information as the data for each bag are entered. For example, "finish" information should never be recorded on a label for an unpainted pottery type, and there should never be a label on which the part entry is recorded as "rim" if there is not also an item number. Any problems discovered during data entry are corrected on both the analysis label and in the

database at that time. When all the data for the entire pottery bag have been entered, the data are printed out and checked again against the information on each analysis label. Once all the problems have been corrected, the smaller bags are nested back inside the original “bulk sherds, large” bag (with the FS label), and the final, clean analysis data are printed and filed in a notebook by PD-FS. The artifact bag is placed in a box labeled “Bulk Sherds, Large—analyzed, entered, bag checked.”

After all the pottery collected during a given field season has been analyzed, a set of standard queries is run against the pottery database. These queries are designed to find errors, missing data, and logical inconsistencies in the pottery data. For example, when our pottery analysis procedures are followed correctly, there will be no records for which the “part” entry is “rim” and the “count” entry is greater than 1; there will be no records with an item number that also have a count greater than 1; there will be no records for which the “type” entry is an unpainted pottery type and a paint type is entered in the “finish” field, and so forth. Each query we run generates a printout that lists the pottery bags for which there are logical problems like these in the associated data. In most cases, the problem bags have to be retrieved from storage and the data checked against the herds to resolve the problem. As problems are resolved, the appropriate corrections are made on the relevant analysis labels, if necessary, and on the printout generated by the query. The database entries are then corrected, a new analysis data report is printed and filed, and the old analysis report is discarded. When all problems encountered through this process have been resolved, the bags of analyzed and data checked pottery are put in PD-FS order in cardboard flats labeled “Site number/ BSL —data checked/ PD_____FS_____ through PD_____FS_____” and stored in the curation room. The analysis data reports are also filed in PD-FS order in a folder or notebook labeled “Pottery Analysis—data checked.” When we complete the pottery analysis for an excavation project, the same standard queries are run again to make sure that all problem records have been fixed. These final queries also systematically check to make sure that every bag of cataloged “bulk sherds, large” from the site has been analyzed and the resulting data have been entered into the database.

Datachecks: Chipped-Stone Analysis

Bulk chipped stone is analyzed by staff, adult participants, interns, and volunteers (see Chapter 9). The resultant data are recorded on analysis sheets and on the analysis labels that are placed in the bags with the artifacts. As is the case with pottery analysis, one or more staff members check each sort performed by participants, volunteers, and/or interns before the resultant piles of artifacts are bagged, labeled, and recorded on the analysis sheet. The analyzed bags of bulk chipped stone are put in boxes labeled “BCS Analyzed,” and the analysis sheets are filed. The data are entered into the database from the analysis sheets. The staff person or intern entering the data looks for missing and/or inconsistent data and attempts to correct any errors. If it is not possible to resolve an error without looking at the artifacts again, the problem is noted on a problem sheet.

At the end of each field season, the analysis forms are put in PD-FS order, the bulk chipped stone data are printed out, and the analysis forms are compared line-by line with the database

records. Any data-entry errors are noted and corrected in the database and on the analysis forms at that time. After this edit has been completed, the database is queried for bags of chipped stone that have contradictory data in various fields, as is done for the pottery-analysis data. When errors are discovered, the relevant bulk chipped stone bag is found, the artifacts are taken out, and the analysis labels are checked to the artifacts. The data must then be corrected on the analysis sheet and labels, as well as in the computer database. When all the problems have been resolved, the bags of analyzed and data checked bulk-chipped stone are put in PD-FS order in cardboard flats labeled “site number/ BCS— data checked/ PD____-FS____ through PD____-FS____” and stored in the curation room. At the end of each project, these queries are run again and any additional problems are resolved. Queries are also run at this time to make sure that all cataloged bags of bulk chipped stone have been analyzed.

Data Validation

In addition to the quality-control procedures we perform during analysis and data entry, we have also incorporated quality-control measures into the design of the database itself. These hardwired checks prevent certain kinds of analytical and typing errors from being entered in the first place, and they provide the staff with numerous opportunities for problem records to be identified. The first check we have hardwired is a check for valid codes. Every field that stores category information in our artifact data tables is linked to a “lookup table” that specifies the list of codes that are valid entries for that field. If the person entering the data attempts to type in an invalid code, the database will return an error message. If the invalid code resulted from a typing error during data entry, it can be fixed immediately. If the invalid code was recorded during analysis and the correct code cannot be determined, then that record is not entered and a note is added to a problem sheet.

A second hardwired check prevents the entry of invalid key-field combinations. Key-fields are fields that, taken together, uniquely identify individual records of specific data tables. For example, the key-fields in the PD table are “Site Number” and “PD Number,” and the key-fields in the FS table are “Site Number,” “PD Number,” and “FS Number.” When someone enters artifact data, the computer checks to make sure that the site number and PD number written on a recording sheet or analysis label are associated with an existing record in the PD table. If a record for that site and PD number does not exist in the PD table, the computer will return an error message and will not allow artifact data from the unknown PD to be entered. Most of these errors are simple typing or recording errors, but making sure these do not occur is extremely important if we are to maintain provenience control over our collections.

A third hardwired check verifies that our analysis data are associated with the correct PD and FS numbers. When we enter pottery-analysis data into the pottery table, the computer checks the FS table to make sure that the site, PD, and FS numbers on each analysis label correspond to a record for an artifact category that is indeed pottery (bulk sherds, large; bulk sherds, small; modified sherd, shaped sherd, or “other ceramic artifact”). If this is not the case, an error message is returned. Such errors can result from FS data-entry errors, pottery-analysis recording errors, or typing errors. The same cross-checking process occurs during data entry for chipped-

stone, archaeobotanical, and tree-ring analysis.

A fourth hardwired check ensures that the analysis data we receive from specialists contain no invalid codes, missing data, or key-field errors before we add the data to our database. An error list is printed, and the data problems are resolved before the data are transferred to the database.

Final Checks

The final check of an artifact collection and its associated records is performed as the collection is prepared for curation (see Chapter 13). At that time, artifact bags are organized by artifact category, PD number, and FS number, and the original, handwritten FS label inside each bag is replaced by a computer-generated label. During this process, any remaining problems with the provenience labels in artifact bags are identified and corrected. When all issues are resolved and labels have been replaced, a final artifact inventory for a given collection is printed from the database.

References Cited

Adams 2004*1

Adams, K. R.

2004 *Archaeobotanical Analysis: Principles and Methods* [HTML Title]. Available: <http://www.crowcanyon.org/plantmethods>.

Andrefsky 1998*1

Andrefsky, William, Jr.

1998 *Lithics: Macroscopic Approaches to Analysis*. Cambridge University Press, Cambridge.

Beals et al. 1945*1

Beals, R. L., G. W. Brainerd, and W. Smith

1945 *Archaeological Studies in Northeast Arizona: A Report on the Archaeological Work of the Rainbow Bridge–Monument Valley Expedition*. University of California Publications in American Archaeology and Ethnology, vol. 44, no. 1. University of California Press, Berkeley.

Blinman 1993*1

Blinman, E.

1993 Anasazi Pottery: Evolution of a Technology. *Expedition* 35(1):14–22.

Breternitz et al. 1974*1

Breternitz, D. A., A. H. Rohn, Jr., and E. A. Morris (compilers)

1974 *Prehistoric Ceramics of the Mesa Verde Region*. Ceramic Series, no. 5. Museum of Northern Arizona, Flagstaff.

Cotterell and Kamminga 1979*1

Cotterell, B., and J. Kamminga

1979 The Mechanics of Flaking. In *Lithic Use-Wear Analysis*, edited by B. Hayden, pp. 97–112. Academic Press, New York.

Crow Canyon Archaeological Center 1990*1

Crow Canyon Archaeological Center

1990 Crow Canyon Archaeological Center Ceramic Typology Guide. Manuscript on file, Crow Canyon Archaeological Center, Cortez, Colorado.

Crow Canyon Archaeological Center 2001*1

Crow Canyon Archaeological Center

2001 *The Crow Canyon Archaeological Center Field Manual* [HTML Title]. Available: <http://www.crowcanyon.org/fieldmanual>.

Geib 1996*1

Geib, P. R.

- 1996 Formative Cultures and Boundaries: Reconsideration of the Fremont and Anasazi. In *Glen Canyon Revisited*, authored by P. R. Geib, pp. 98–114. University of Utah Anthropological Papers, no. 119. University of Utah Press, Salt Lake City.

Gerhardt 2001*1

Gerhardt, K.

- 2001 Lithic Source Materials Classification Standards. Manuscript on file, Anasazi Heritage Center, Dolores, Colorado.

Hayes 1964*1

Hayes, A. C.

- 1964 *The Archeological Survey of Wetherill Mesa, Mesa Verde National Park, Colorado*. Archeological Research Series, no. 7-A. National Park Service, Washington, D.C.

Hayes and Lancaster 1975*1

Hayes, A. C., and J. A. Lancaster

- 1975 *Badger House Community, Mesa Verde National Park*. Publications in Archeology, no. 7E. National Park Service, Washington, D.C.

Holmer 1986*1

Holmer, R. N.

- 1986 Common Projectile Points of the Intermountain West. In *Anthropology of the Desert West: Essays in Honor of Jesse D. Jennings*, edited by C. J. Condie and D. D. Fowler, pp. 89–115. Anthropological Papers, no. 110. University of Utah Press, Salt Lake City.

Irwin-Williams 1973*1

Irwin-Williams, C.

- 1973 *The Oshara Tradition: Origins of Anasazi Culture*. Contributions in Anthropology, vol. 5, no. 1. Eastern New Mexico University, Portales.

Lekson 1997*1

Lekson, S. H.

- 1997 Points, Knives, and Drills of Chaco Canyon. In *Ceramics, Lithics, and Ornaments of Chaco Canyon: Analyses of Artifacts from the Chaco Project, 1971–1978, Volume II: Lithics*, edited by F. J. Mathien, pp. 659–697. Publications in Archeology, no. 18G. National Park Service, Santa Fe.

Lightfoot and Etzkorn 1993*1

Lightfoot, R. R., and M. C. Etzkorn (editors)

- 1993 *The Duckfoot Site, Volume I: Descriptive Archaeology*. Occasional Papers, no. 3. Crow Canyon Archaeological Center, Cortez, Colorado.

Lipe 1974*1

Lipe, W. D.

1974 A Conservation Model for American Archaeology. *The Kiva* 39:213–245.

Lyle and Tucholke 2003*1

Lyle, R., and D. R. Tucholke

2003 A General Guide to Temper Analysis. Manuscript on file, Crow Canyon Archaeological Center, Cortez, Colorado.

Morris 1927*1

Morris, E. H.

1927 *The Beginnings of Pottery Making in the San Juan Area: Unfired Prototypes and Wares of the Earliest Ceramic Period*. Anthropological Papers, vol. 28, part 2. American Museum of Natural History, New York

Ortman 2000*2

Ortman, S. G.

2000 Artifacts. In *The Archaeology of Castle Rock Pueblo: A Thirteenth-Century Village in Southwestern Colorado* [HTML Title], edited by K. A. Kuckelman. Available: <http://www.crowcanyon.org/castlerock>.

Ortman 2002*1

Ortman, S. G.

2002 Artifacts. In *The Archaeology of Woods Canyon Pueblo: A Canyon-Rim Village in Southwestern Colorado* [HTML Title], edited by M. J. Churchill. Available: <http://www.crowcanyon.org/woodscanyon>.

Ortman 2003*1

Ortman, S. G.

2003 Artifacts. In *The Archaeology of Yellow Jacket Pueblo: Excavations at a Large Community Center in Southwestern Colorado* [HTML Title], edited by K. A. Kuckelman. Available: <http://www.crowcanyon.org/yellowjacket>.

Pierce et al. 1999*2

Pierce, C., M. D. Varien, J. C. Driver, G. T. Gross, and J. W. Keleher

1999 Artifacts. In *The Sand Canyon Archaeological Project: Site Testing* [HTML Title], edited by M. D. Varien, Chapter 15. Available: <http://www.crowcanyon.org/sitetesting>.

Thomas 1981*1

Thomas, D. H.

1981 How to Classify the Projectile Points from Monitor Valley, Nevada. *Journal of California and Great Basin Anthropology* 3:7–43.

Whittaker 1994*1

Whittaker, J. C.

1994 *Flintknapping: Making and Understanding Stone Tools*. University of Texas Press, Austin.

Wilson 1991*1

Wilson, C. D.

1991 Ceramic Analysis: Hovenweep Laterals Project. In *Archaeological Excavations on the Hovenweep Laterals*, authored by J. N. Morris, pp. 677–762. Complete Archaeological Service Associates, Cortez, Colorado.

Wilson and Blinman 1988*1

Wilson, C. D., and E. Blinman

1988 Identification of Non–Mesa Verde Ceramics in Dolores Archaeological Program Collections. In *Dolores Archaeological Program: Supporting Studies: Additive and Reductive Technologies*, compiled by E. Blinman, C. J. Phagan, and R. H. Wilshusen, pp. 363–374. Bureau of Reclamation, Engineering and Research Center, Denver.

Wilson and Blinman 1995*1

Wilson, C. D., and E. Blinman

1995 Ceramic Types of the Mesa Verde Region. In *Archaeological Pottery of Colorado: Ceramic Clues to the Prehistoric and Protohistoric Lives of the State's Native Peoples*, edited by R. H. Brunswig, Jr., B. Bradley, and S. Chandler, pp. 33–64. Occasional Papers, no. 2. Colorado Council of Professional Archaeologists, Denver.

Wilson and Blinman 1999*2

Wilson, C. D., and E. Blinman

1999 Pottery Dating. In *The Sand Canyon Archaeological Project: Site Testing* [HTML Title], edited by M. D. Varien, Appendix A(2). Available: <http://www.crowcanyon.org/sitetesting>.